

6.3 1/4" Socket set
V3734, EAN 4047728037341

6.3 1/4" Steckschlüssel-Satz
V3734, EAN 4047728037341



X	Design Ausführung	6.3 1/4"	Sizes (mm) / SW (mm) / mm
12 x		6.3 1/4"	4 · 4.5 · 5 · 5.5 · 6 · 7 · 8 · 9 · 10 · 11 · 12 · 13 mm
2 x		6.3 1/4"	PH 1 · PH 2
2 x		6.3 1/4"	PZ 1 · PZ 2
4 x		6.3 1/4"	T 15 · T 20 · T 25 · T 30
1 x		6.3 1/4"	100 mm
1 x		6.3 1/4"	25 mm
1 x		6.3 1/4"	150 mm

Single parts from page 44 on
Einzelteilaufistung ab Seite 44



6.3 1/4" Socket set
V2414, EAN 4047728024143

6.3 1/4" Steckschlüssel-Satz
V2414, EAN 4047728024143



X	Design Ausführung	6.3 1/4"	Sizes (mm) / SW (mm) / mm
13 x		6.3 1/4"	4 · 4.5 · 5 · 5.5 · 6 · 7 · 8 · 9 · 10 · 11 · 12 · 13 · 14 mm
3 x		6.3 1/4"	0.8 x 4 · 1 x 5.5 · 1.2 x 7 mm
6 x		6.3 1/4"	3 · 4 · 5 · 6 · 7 · 8 mm
3 x		6.3 1/4"	PH 1 · PH 2 · PH 3
3 x		6.3 1/4"	PZ 1 · PZ 2 · PZ 3
6 x		6.3 1/4"	T 10 · T 15 · T 20 · T 25 · T 30 · T 40
4 x		6.3 1/4"	1.27 · 1.5 · 2 · 2.5 mm
1 x		6.3 1/4"	145 mm
1 x		6.3 1/4"	110 mm
1 x		6.3 1/4"	50 mm
2 x		6.3 1/4"	100 · 145 mm
1 x		6.3 1/4"	40 mm
1 x		6.3 1/4"	150 mm
1 x		6.3 1/4"	150 mm

Single parts from page 44 on
Einzelteilaufistung ab Seite 44



Socket Systems 6.3 1/4"
Steckschlüssel-Systeme 6.3 1/4"



6.3 1/4" Socket set with multi-purpose profile
V4217, EAN 4047728042178

6.3 1/4" Multiprofil Steckschlüssel-Satz
V4217, EAN 4047728042178



Available in February
Erhältlich ab Februar



6.3 1/4"



X	Design Ausführung	6.3 1/4"	Sizes (mm) / SW (mm) / mm
13 x		6.3 1/4"	4 · 4.5 · 5 · 5.5 · 6 · 7 · 8 · 9 10 · 11 · 12 · 13 · 14 mm
6 x		6.3 1/4"	3 · 4 · 5 · 6 · 7 · 8 mm
2 x		6.3 1/4"	PH 1 · PH 2
2 x		6.3 1/4"	PZ 1 · PZ 2
6 x		6.3 1/4"	T 10 · T 15 · T 20 · T 25 · T 27 · T 30 · T 40
5 x		6.3 1/4"	M4 · M5 · M5 · M8 · M10
1 x		6.3 1/4"	—
1 x		6.3 1/4"	100
1 x		6.3 1/4"	40 mm
1 x		6.3 1/4"	150 mm
1 x		6.3 1/4"	152 mm

Single parts from page 44 on
Einzelteilaufistung ab Seite 44



6.3 1/4" Socket set with multi-purpose profile
V1897, EAN 4047728018975

6.3 1/4" Multiprofil Steckschlüssel-Satz
V1897, EAN 4047728018975



6.3 1/4"



Multi-purpose screw profiles / Multiprofile

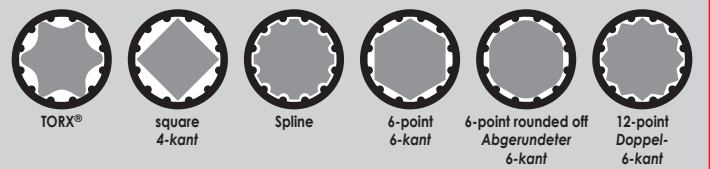

All sockets suitable for
6 different profiles!
Alle Einsätze für
6 Profile geeignet!



X	Design Ausführung	Sizes (mm) SW (mm)
12 x		4 · 5 · 5.5 · 6 · 7 · 8 · 9 · 10 · 11 · 12 · 13 · 14 mm

Single parts see page 44
Einzelteilaufistung Seite 44



$\frac{1}{4}$ " Socket

$\frac{1}{4}$ " Steckschlüssel-Einsatz



VIGOR No.	Sizes (mm) SW (mm)	mm	EAN 4047728+
V2413	4	25	024136
V2415	4.5	25	024150
V2416	5	25	024167
V2417	5.5	25	024174
V2418	6	25	024181
V2419	7	25	024198
V2420	8	25	024204
V2421	9	25	024211
V2422	10	25	024228
V2423	11	25	024235
V2424	12	25	024242
V2425	13	25	024259
V2426	14	25	024266

$\frac{1}{4}$ " Socket, long

$\frac{1}{4}$ " Steckschlüssel-Einsatz, lang



VIGOR No.	Sizes (mm) SW (mm)	mm	EAN 4047728+
V2533	4	50	025331
V2534	5	50	025348
V2535	6	50	025355
V2536	7	50	025362
V2537	8	50	025379
V2538	9	50	025386
V2539	10	50	025393
V2699	11	50	026994
V2700	12	50	027007
V2701	13	50	027014

$\frac{1}{4}$ " TORX® socket

$\frac{1}{4}$ " TORX® Steckschlüssel-Einsatz



VIGOR No.	Sizes (mm) SW (mm)	mm	EAN 4047728+
V2185	E 4	24.8	021852
V2186	E 5	24.8	021869
V2187	E 6	24.8	021876
V2188	E 7	24.8	021883
V2189	E 8	24.8	021890
V2722	E 10	24.8	027229
V2723	E 11	24.8	027236

$\frac{1}{4}$ " Socket with multi-purpose profile

$\frac{1}{4}$ " Multiprofil-Steckschlüssel-Einsatz



VIGOR No.	Sizes (mm) SW (mm)	mm	EAN 4047728+
V1976	4	25	019767
V1977	5	25	019774
V1978	5.5	25	019781
V1979	6	25	019798
V1980	7	25	019804
V1981	8	25	019811
V1982	9	25	019828
V1983	10	25	019835
V1984	11	25	019842
V1985	12	25	019859
V1986	13	25	019866
V1987	14	25	019873

$\frac{1}{4}$ " Screwdriver socket

$\frac{1}{4}$ " Schraubendreher-Einsatz



VIGOR No.	Sizes (mm) SW (mm)	mm	EAN 4047728+
V2430	3	38	024303
V2431	4	38	024310
V2432	5	38	024327
V2433	6	38	024334
V2434	7	38	024341
V2435	8	38	024358

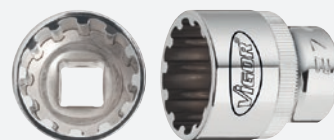

Multi-purpose screw profiles / Multiprofile

TORX® square 4-kant Spline 6-point 6-kant 6-point rounded off Abgerundeter 6-kant 12-point Doppel-6-kant

$\frac{1}{4}$ " Screwdriver socket

$\frac{1}{4}$ " Schraubendreher-Einsatz



VIGOR No.	Sizes (mm) SW (mm)	mm	EAN 4047728+
V2427	0.8 x 4	38	024273
V2428	1 x 5.5	38	024280
V2597	1.2 x 6.5	38	025973
V2429	1.2 x 7	38	024297

$\frac{1}{4}$ " Screwdriver socket

$\frac{1}{4}$ " Schraubendreher-Einsatz



VIGOR No.	Sizes (mm) SW (mm)	mm	EAN 4047728+
V2593	PH 0	38	025935
V2436	PH 1	38	024365
V2437	PH 2	38	024372
V2438	PH 3	38	024389

Socket Systems 6.3 1/4" Steckschlüssel-Systeme 6.3 1/4"



6.3 1/4" Screwdriver socket

6.3 1/4" Schraubendreher-Einsatz



VIGOR No.	Sizes (mm) SW (mm)	mm	EAN 4047728+
V2594	PZ 0	38	025942
V2439	PZ 1	38	024396
V2440	PZ 2	38	024402
V2441	PZ 3	38	024419



6.3 1/4" TORX® screwdriver socket

6.3 1/4" TORX® Schraubendreher-Einsatz



VIGOR No.	Sizes (mm) SW (mm)	mm	EAN 4047728+
V2595	T 9	38	025959
V2442	T 10	38	024426
V2443	T 15	38	024433
V2444	T 20	38	024440
V2445	T 25	38	024457
V2446	T 30	38	024464
V2447	T 40	38	024471



6.3 1/4" Screwdriver socket

6.3 1/4" Schraubendreher-Einsatz



VIGOR No.	Sizes (mm) SW (mm)	mm	EAN 4047728+
V2596	T 9 H	38	025966
V2136	T 10 H	37	021364
V2138	T 15 H	37	021388
V2139	T 20 H	37	021395
V2140	T 25 H	37	021401
V2141	T 27 H	37	021418
V2142	T 30 H	37	021425



6.3 1/4" Spin type speeder

6.3 1/4" Steckgriff



VIGOR No.	mm	EAN 4047728+
V2458	150	024587



6.3 1/4" Fine-tooth reversible ratchet

6.3 1/4" Feinzahn-Umschaltknarre

6.3 1/4"

VIGOR No.	mm	EAN 4047728+
V1038	150	010382



Repair set
Reparatur-Satz

V3585, EAN 4047728035859

6.3 1/4" Reversible ratchet with T-handle

6.3 1/4" T-Griff-Umschaltknarre

6.3 1/4"

VIGOR No.	mm	EAN 4047728+
V1032	150	010320



6.3 1/4" Finger ratchet

6.3 1/4" Fingerratsche

6.3 1/4"



VIGOR No.	EAN 4047728+
V2941	029414

6.3 1/4" Fine-tooth reversible ratchet

6.3 1/4" Feinzahn-Umschaltknarre

6.3 1/4"



VIGOR No.	mm	EAN 4047728+
V4212	150	042123

6.3 1/4" Sliding T-handle

6.3 1/4" Gleitgriff

6.3 1/4"

VIGOR No.	mm	EAN
V2453	110	024532



6.3 1/4" 6.3 1/4" Universal joint

6.3 1/4" 6.3 1/4" Universalgelenk

6.3 1/4" 6.3 1/4"

VIGOR No.	mm	EAN
V2454	40	024549



6.3 1/4" 6.3 1/4" Flexible extension

6.3 1/4" 6.3 1/4" Flexible Verlängerung

6.3 1/4" 6.3 1/4"

VIGOR No.	mm	EAN
V2457	145	024570

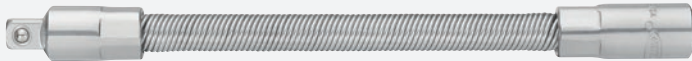

6.3 1/4" 6.3 1/4" Extension

6.3 1/4" 6.3 1/4" Verlängerung

6.3 1/4" 6.3 1/4"

VIGOR No.	mm	EAN
V2455	50	024556
V2456	100	024563



6.3 1/4" 6.3 1/4" Adapter

6.3 1/4" 6.3 1/4" Adapter

6.3 1/4" 6.3 1/4"

VIGOR No.	mm	EAN
V2452	30	024525



10 3/8" 6.3 1/4" Adapter

10 3/8" 6.3 1/4" Adapter

10 3/8" 6.3 1/4"

VIGOR No.	mm	EAN
V2071	27	020718



6.3 1/4" 6.3 1/4" Bit adapter

6.3 1/4" 6.3 1/4" Bit-Adapter

6.3 1/4" 6.3 1/4"

VIGOR No.	mm	EAN
V3651	25	036511



Socket Systems $10 \frac{3}{8}$ Steckschlüssel-Systeme $10 \frac{3}{8}$



$10 \frac{3}{8}$ Socket set
V2305, EAN 4047728023054



$10 \frac{3}{8}$ Steckschlüssel-Satz
V2305, EAN 4047728023054



X	Design Ausführung	Sizes (mm) / SW (mm) / mm
18 x		6 · 7 · 8 · 9 · 10 · 11 · 12 · 13 · 14 · 15 · 16 · 17 · 18 · 19 · 20 · 21 · 22 · 24 mm
10 x		8 · 9 · 10 · 11 · 12 · 13 · 14 · 15 · 17 · 19 mm
2 x		16 · 21 mm
7 x		3 · 4 · 5 · 6 · 7 · 8 · 10 mm
3 x		0.8 x 5.5 · 1 x 7 · 1.2 x 8 mm
3 x		PH 1 · PH 2 · PH 3
3 x		PZ 1 · PZ 2 · PZ 3
9 x		T 15 · T 20 · T 25 · T 27 · T 30 · T 40 · T 45 · T 50 · T 55
1 x		-
1 x		40 mm
1 x		75 mm
1 x		250 mm
1 x		50 mm
1 x		198 mm

Single parts from page 48 on
Einzelteilaufistung ab Seite 48

$10 \frac{3}{8}$ Glow plug socket set
V2737, EAN 4047728027373



$10 \frac{3}{8}$ Glühkerzen-Steckschlüssel-Satz
V2737, EAN 4047728027373

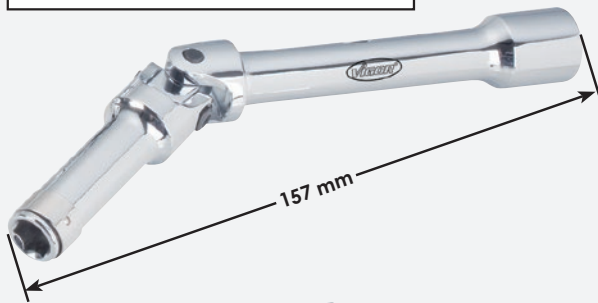
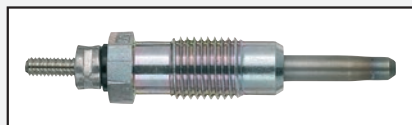

X	Sizes (mm) / SW (mm)
6 x	8 · 9 · 10 · 12 · 14 · 16 mm

Single parts see page 48
Einzelteilaufistung Seite 48

$10 \frac{3}{8}$ Socket ●

$10 \frac{3}{8}$ Steckschlüssel-Einsatz ●



VIGOR No.	Sizes (mm) SW (mm)	mm	EAN 4047728+
V2278	6	28	022781
V2277	7	28	022774
V2276	8	28	022767
V2275	9	28	022750
V2274	10	28	022743
V2273	11	28	022736
V2272	12	28	022729
V2271	13	28	022712
V2270	14	28	022705
V2269	15	28	022699
V2268	16	28	022682
V2267	17	30	022675
V2266	18	30	022668
V2265	19	30	022651
V2264	20	30	022644
V2263	21	30	022637
V2262	22	30	022620
V2261	24	30	022613

$10 \frac{3}{8}$ Socket, long ●

$10 \frac{3}{8}$ Steckschlüssel-Einsatz, lang ●



VIGOR No.	Sizes (mm) SW (mm)	mm	EAN 4047728+
V2016	8	63	020169
V2017	9	63	020176
V2018	10	63	020183
V2019	11	63	020190
V2020	12	63	020206
V2311	13	63	023115
V2312	14	63	023122
V2313	15	63	023139
V2314	17	63	023146
V2315	19	63	023153

$10 \frac{3}{8}$ Spark plug socket ●

$10 \frac{3}{8}$ Zündkerzen-Einsatz ●

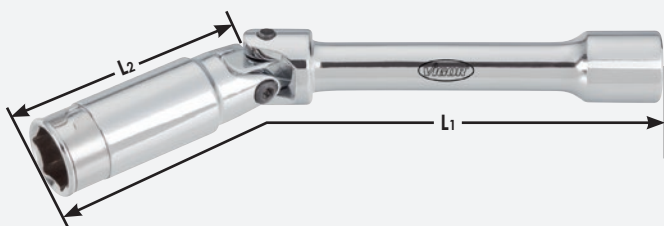

VIGOR No.	Sizes (mm) SW (mm)	Total Gesamt mm	Blade Klinge mm	EAN 4047728+
V2738	8	157	45	027380
V2741	9	157	45	027410
V2742	10	157	45	027427
V2743	12	157	45	027434
V2744	14	157	45	027441
V2739	16	157	45	027397

$10 \frac{3}{8}$ Spark plug socket ●

$10 \frac{3}{8}$ Zündkerzen-Einsatz ●



VIGOR No.	Sizes (mm) SW (mm)	mm	EAN 4047728+
V2119	16	66	021197
V2613	18	66	026130
V2120	21	66	021203



www.VIGOR-equipment.com

$10 \frac{3}{8}$ TORX® socket ●

$10 \frac{3}{8}$ TORX® Steckschlüssel-Einsatz ●



VIGOR No.	Sizes (mm) SW (mm)	mm	EAN 4047728+
V2724	E 4	28	027243
V2725	E 5	28	027250
V2726	E 6	28	027267
V2727	E 7	28	027274
V2728	E 8	28	027281
V2143	E 10	28	021432
V2614	E 11	28	026147
V2144	E 12	28	021449
V2145	E 14	28	021456
V2146	E 16	28	021463
V2615	E 18	28	026154
V2729	E 20	28	027298

Socket Systems $10 \frac{3}{8}$ Steckschlüssel-Systeme $10 \frac{3}{8}$



$10 \frac{3}{8}$ Screwdriver socket \odot

$10 \frac{3}{8}$ Schraubendreher-Einsatz \odot



VIGOR No.	Sizes (mm) SW (mm)	mm	EAN 4047728+
V2285	3	49	022859
V2284	4	49	022842
V2283	5	49	022835
V2282	6	49	022828
V2281	7	49	022811
V2280	8	49	022804
V2279	10	49	022798

$10 \frac{3}{8}$ Screwdriver socket \ominus

$10 \frac{3}{8}$ Schraubendreher-Einsatz \ominus



VIGOR No.	Sizes (mm) SW (mm)	mm	EAN 4047728+
V2288	0.8 x 5.5	49	022880
V2287	1 x 7	49	022873
V2286	1.2 x 8	49	022866

$10 \frac{3}{8}$ Screwdriver socket \oplus

$10 \frac{3}{8}$ Schraubendreher-Einsatz \oplus



VIGOR No.	Sizes (mm) SW (mm)	mm	EAN 4047728+
V2294	PH 1	49	022941
V2293	PH 2	49	022934
V2292	PH 3	49	022927

$10 \frac{3}{8}$ Screwdriver socket \oplus

$10 \frac{3}{8}$ Schraubendreher-Einsatz \oplus



VIGOR No.	Sizes (mm) SW (mm)	mm	EAN 4047728+
V2291	PZ 1	49	022910
V2290	PZ 2	49	022903
V2289	PZ 3	49	022897

$10 \frac{3}{8}$ TORX® screwdriver socket \odot

$10 \frac{3}{8}$ TORX® Schraubendreher-Einsatz \odot



VIGOR No.	Sizes (mm) SW (mm)	mm	EAN 4047728+
V2303	T 15	49	023030
V2302	T 20	49	023023
V2301	T 25	49	023016
V2300	T 27	49	023009
V2299	T 30	49	022996
V2298	T 40	49	022989
V2297	T 45	49	022972
V2149	T 47	49	021494
V2296	T 50	49	022965
V2295	T 55	49	022958

$10 \frac{3}{8}$ TORX® screwdriver socket \oplus

$10 \frac{3}{8}$ TORX® Schraubendreher-Einsatz \oplus



VIGOR No.	Sizes (mm) SW (mm)	mm	EAN 4047728+
V2193	T 40 H	48	021937
V2194	T 45 H	48	021944
V2195	T 50 H	48	021951

$10 \frac{3}{8}$ Fine-tooth reversible ratchet

$10 \frac{3}{8}$ Feinzahn-Umschaltknarre

$10 \frac{3}{8}$



2K System

VIGOR No.	mm	EAN 4047728+
V2304	198	023047

Repair set
Reparatur-Satz
V3584, EAN 4047728035842

$10 \frac{3}{8}$ $125 \frac{1}{2}$ Sliding head/adaptor
 $10 \frac{3}{8}$ $125 \frac{1}{2}$ Schiebestück/Adapter

$10 \frac{3}{8}$ $125 \frac{1}{2}$

VIGOR No.	mm	EAN 4047728+
V2116	40	021166



$10 \frac{3}{8}$ $10 \frac{3}{8}$ Universal joint
 $10 \frac{3}{8}$ $10 \frac{3}{8}$ Universalgelenk

$10 \frac{3}{8}$ $10 \frac{3}{8}$

VIGOR No.	mm	EAN 4047728+
V2118	50	021180



$8 \frac{5}{16}$ $10 \frac{3}{8}$ Bit adapter
 $8 \frac{5}{16}$ $10 \frac{3}{8}$ Bit-Adapter

$8 \frac{5}{16}$ $10 \frac{3}{8}$

VIGOR No.	mm	EAN 4047728+
V2114	28	021142



$6.3 \frac{1}{4}$ $10 \frac{3}{8}$ Adapter
 $6.3 \frac{1}{4}$ $10 \frac{3}{8}$ Adapter

$6.3 \frac{1}{4}$ $10 \frac{3}{8}$

VIGOR No.	mm	EAN 4047728+
V2014	26	020145



$125 \frac{1}{2}$ $10 \frac{3}{8}$ Adapter
 $125 \frac{1}{2}$ $10 \frac{3}{8}$ Adapter

$125 \frac{1}{2}$ $10 \frac{3}{8}$

VIGOR No.	mm	EAN 4047728+
V2108	36	021081



$10 \frac{3}{8}$ $10 \frac{3}{8}$ Bit adapter
 $10 \frac{3}{8}$ $10 \frac{3}{8}$ Bit-Adapter

$10 \frac{3}{8}$ $10 \frac{3}{8}$

VIGOR No.	mm	EAN 4047728+
V3652	30	036528



$10 \frac{3}{8}$ $10 \frac{3}{8}$ Extension
 $10 \frac{3}{8}$ $10 \frac{3}{8}$ Verlängerung

$10 \frac{3}{8}$ $10 \frac{3}{8}$

VIGOR No.	mm	EAN 4047728+
V2115	75	021159
V2616	125	026161
V2117	250	021173



Socket Systems $\frac{12.5}{16}$ 1/2"

Steckschlüssel-Systeme $\frac{12.5}{16}$ 1/2"



$\frac{12.5}{16}$ Socket set
V2460, EAN 4047728024600



$\frac{12.5}{16}$ Steckschlüssel-Satz
V2460, EAN 4047728024600

$\frac{12.5}{16}$ 1/2"

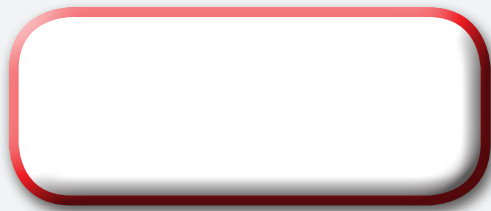

	Design Ausführung	Sizes (mm) SW (mm) / mm
18 x		10 · 11 · 12 · 13 · 14 · 15 · 16 · 17 · 18 · 19 20 · 21 · 22 · 23 · 24 · 27 · 30 · 32 mm
2 x		16 · 21 mm
1 x		250 mm
1 x		125 mm
1 x		250 mm
1 x		75 mm
1 x		250 mm

Single parts from page 56 on
Einzelteilaufistung ab Seite 56

$\frac{12.5}{16}$ Socket set with multi-purpose profile
V1898, EAN 4047728018982



$\frac{12.5}{16}$ Multiprofil Steckschlüssel-Satz
V1898, EAN 4047728018982

$\frac{12.5}{16}$ 1/2"



Multi-purpose screw profiles / Multiprofile

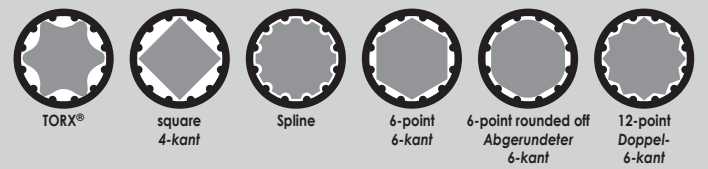

All sockets suitable for
6 different profiles!
Alle Einsätze für
6 Profile geeignet!



	Design Ausführung	Sizes (mm) SW (mm)
17 x		10 · 11 · 12 · 13 · 14 · 15 · 16 · 17 · 18 · 19 20 · 21 · 22 · 24 · 27 · 30 · 32 mm

Single parts see page 56
Einzelteilaufistung Seite 56



$12\frac{5}{16}$ " TORX® screwdriver socket set
V1917, EAN 4047728019170

$12\frac{5}{16}$ " TORX® Schraubendreher-
Einsatz-Sortiment
V1917, EAN 4047728019170



$12\frac{5}{16}$ "



	Design Ausführung	Sizes (mm) SW (mm)
10 x		T 20 · T 25 · T 27 · T 30 · T 40 · T 45 · T 50 · T 55 · T 60 · T 70
10 x		T 20 · T 25 · T 27 · T 30 · T 40 · T 45 · T 50 · T 55 · T 60 · T 70
6 x		T 40 · T 45 · T 50 · T 55 · T 60 · T 70
6 x		T 40 · T 45 · T 50 · T 55 · T 60 · T 70

Single parts see page 58
Einzelteilaufistung Seite 58

$12\frac{5}{16}$ " Screwdriver socket set for screws
with internal serration (XZIN)
V1918, EAN 4047728019187

$12\frac{5}{16}$ " Innenvielzahn Schraubendreher-
Einsatz-Sortiment (XZIN)
V1918, EAN 4047728019187



$12\frac{5}{16}$ "



	Design Ausführung	Sizes (mm) SW (mm)
8 x		M 5 · M 6 · M 8 · M 9 · M 10 · M 12 · M 14 · M 16
7 x		M 5 · M 6 · M 8 · M 9 · M 10 · M 12 · M 14
7 x		M 5 · M 6 · M 8 · M 9 · M 10 · M 12 · M 14
4 x		M 8 · M 10 · M 12 · M 14

Single parts see page 57
Einzelteilaufistung Seite 57

Socket Systems $12\frac{5}{8}$ 1/2"

Steckschlüssel-Systeme $12\frac{5}{8}$ 1/2"



$12\frac{5}{8}$ 1/2" Screwdriver socket set
for inside hexagon
V1919, EAN 4047728019194



$12\frac{5}{8}$ 1/2" Innensechskant Schraubendreher-
Einsatz-Sortiment
V1919, EAN 4047728019194

$12\frac{5}{8}$ 1/2"



	Design Ausführung	Sizes (mm) SW (mm)
9 x		5 · 6 · 7 · 8 · 10 · 12 · 14 · 17 · 19 mm
8 x		5 · 6 · 7 · 8 · 10 · 11 · 12 · 13 mm
7 x		5 · 6 · 7 · 8 · 10 · 12 · 14 mm
6 x		5 · 6 · 7 · 8 · 10 · 12 mm

Single parts see page 57
Einzelteilaufistung Seite 57



$12\frac{5}{8}$ 1/2" RIBE Screwdriver socket set
V2201, EAN 4047728022019



$12\frac{5}{8}$ 1/2" RIBE Schraubendreher-
Einsatz-Sortiment
V2201, EAN 4047728022019

$12\frac{5}{8}$ 1/2"



	Design Ausführung	Sizes (mm) SW (mm)
9 x		M 5 · M 6 · M 7 · M 8 · M 9 · M 10 · M 12 · M 13 · M 14
9 x		M 5 · M 6 · M 7 · M 8 · M 9 · M 10 · M 12 · M 13 · M 14
7 x		M 8 · M 9 · M 10 · M 10.3 · M 12 · M 13 · M 14
7 x		M 8 · M 9 · M 10 · M 10.3 · M 12 · M 13 · M 14

Single parts see page 58
Einzelteilaufistung Seite 58



$12\frac{5}{8}$ 1/2 Screwdriver socket set
V2496, EAN 4047728024969



$12\frac{5}{8}$ 1/2 Schraubendreher-Einsatz-Sortiment
V2496, EAN 4047728024969



Design Ausführung	Sizes (mm) SW (mm)
8 x	M 5 · M 6 · M 8 · M 9 · M 10 · M 12 · M 14 · M 16
9 x	5 · 6 · 7 · 8 · 10 · 12 · 14 · 17 · 19 mm
9 x	M 5 · M 6 · M 7 · M 8 · M 9 · M 10 · M 12 · M 13 · M 14
10 x	T 20 · T 25 · T 27 · T 30 · T 40 · T 45 · T 50 · T 55 · T 60 · T 70

Single parts from page 57 on
Einzelteilaufistung ab Seite 57

$12\frac{5}{8}$ 1/2 Extractor socket set with spiral profile

• Special profile sockets for releasing defective nuts and bolt heads

$12\frac{5}{8}$ 1/2 Spiralnutenausdreher-Einsatz-Sortiment

• Spezialprofil zum Lösen von Muttern mit rundgedrehten Köpfen



$12\frac{5}{8}$ 1/2



V2404, EAN 4047728024044

Design Ausführung	Sizes (mm) SW (mm)
9 x	10 · 11 · 12 · 13 · 14 · 15 16 · 17 · 19 mm



Single parts see page 60
Einzelteilaufistung Seite 60



$12\frac{5}{8}$ 1/2



V3741, EAN 4047728037419

Design Ausführung	Sizes (mm) SW (mm)
6 x	21 · 22 · 24 · 27 · 30 · 32 mm



Single parts see page 60
Einzelteilaufistung Seite 60

Socket Systems $12\frac{5}{8}$ 1/2

Steckschlüssel-Systeme $12\frac{5}{8}$ 1/2



VDE socket set

V3343, EAN 4047728033435





• VDE insulated up to 1000 V according to DIN EN 60900

VDE-Steckschlüssel-Satz

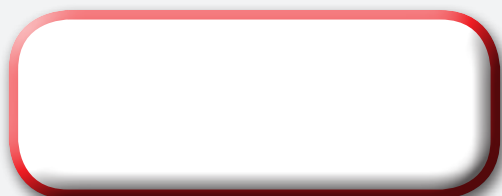
V3343, EAN 4047728033435

• VDE isoliert bis 1000 V nach DIN EN 60900

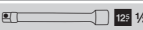

	Design Ausführung	Sizes (mm) SW (mm) / mm
9 x		8 · 10 · 12 · 13 · 14 · 17 · 19 · 22 · 24 mm
3 x		5 · 6 · 8 mm
1 x	 $12\frac{5}{8}$ 1/2	125 mm
1 x	 $12\frac{5}{8}$ 1/2	255 mm

Single parts see page 61
Einzelteilaufistung Seite 61

$12\frac{5}{16}$ 1/2 Socket ●

$12\frac{5}{16}$ 1/2 Steckschlüssel-Einsatz ●



VIGOR No.	Sizes (mm) SW (mm)	mm	EAN 4047728+
V2465	10	38	024655
V2598	11	38	025980
V2603	12	38	026031
V2599	13	38	025997
V2600	14	38	026000
V2561	15	38	025614
V2562	16	38	025621
V2563	17	38	025638
V2564	18	38	025645
V2565	19	38	025652
V2566	20	38	025669
V2567	21	38	025676
V2568	22	38	025683
V2569	23	38	025690
V2570	24	38	025706
V2571	27	42	025713
V2572	30	44	025720
V2574	32	44	025744

$12\frac{5}{16}$ 1/2 Socket, long ●

$12\frac{5}{16}$ 1/2 Steckschlüssel-Einsatz, lang ●



VIGOR No.	Sizes (mm) SW (mm)	mm	EAN 4047728+
V2579	10	77	025799
V2580	11	77	025805
V2581	12	77	025812
V2584	13	77	025843
V2585	14	77	025850
V2586	15	77	025867
V2587	16	77	025874
V2588	17	77	025881
V2589	18	77	025898
V2590	19	77	025904
V2591	22	77	025911

$12\frac{5}{16}$ 1/2 TORX® socket ●

$12\frac{5}{16}$ 1/2 TORX® Steckschlüssel-Einsatz ●



VIGOR No.	Sizes (mm) SW (mm)	mm	EAN 4047728+
V2730	E 10	38	027304
V2731	E 11	38	027311
V2732	E 12	38	027328
V2733	E 14	38	027335
V2734	E 16	38	027342
V2196	E 18	38.2	021968
V2197	E 20	38.2	021975
V2735	E 22	38	027359
V2592	E 24	38	025928

$12\frac{5}{16}$ 1/2 Spark plug socket ●

$12\frac{5}{16}$ 1/2 Zündkerzen-Einsatz ●



VIGOR No.	Sizes (mm) SW (mm)	mm	EAN 4047728+
V2578	16	66	025782
V2582	21	66	025829

$12\frac{5}{16}$ 1/2 Fine-tooth reversible ratchet

$12\frac{5}{16}$ 1/2 Feinzahn-Umschaltknarre



VIGOR No.	mm	EAN 4047728+
V1020	250	010207



Socket with multi-purpose profile ○

Multiprofil-Steckschlüssel Einsatz ○



VIGOR No.	Sizes (mm) SW (mm)	mm	EAN 4047728+
V1988	10	38	019880
V1989	11	38	019897
V1990	12	38	019903
V1991	13	38	019910
V1992	14	38	019927
V1993	15	38	019934
V1994	16	38	019941
V1995	17	38	019958
V1996	18	38	019965
V1997	19	38	019972
V1998	20	38	019989
V1999	21	38	019996
V2000	22	38	020008
V2001	24	40	020015
V2002	27	42	020022
V2003	30	45	020039
V2004	32	45	020046

Repair set
Reparatur-Satz
V3587, EAN 4047728035873



Multi-purpose screw profiles Multiprofile

- TORX®
- square 4-kant
- Spline
- 6-point 6-kant
- 6-point rounded off Abgerundeter 6-kant
- 12-point Doppel-6-kant

Socket Systems $\frac{1}{2}$ "

Steckschlüssel-Systeme $\frac{1}{2}$ "



$\frac{1}{2}$ " Screwdriver socket for inside hexagon \odot

$\frac{1}{2}$ " Innensechskant Schraubendreher-Einsatz \odot



$\frac{1}{2}$ "



VIGOR No.	Sizes (mm) SW (mm)	mm	EAN 4047728+
V2101	5	55	021012
V2102	6	55	021029
V2103	7	55	021036
V2104	8	55	021043
V2105	10	55	021050
V2106	12	55	021067
V2107	14	55	021074
V2069	17	55	020695
V2070	19	55	020701

$\frac{1}{2}$ " Screwdriver socket for inside hexagon \odot

$\frac{1}{2}$ " Innensechskant Schraubendreher-Einsatz \odot



$\frac{1}{2}$ "



VIGOR No.	Sizes (mm) SW (mm)	mm	EAN 4047728+
V2072	5	100	020725
V2073	6	100	020732
V2074	7	100	020749
V2075	8	100	020756
V2076	10	100	020763
V2077	11	100	020770
V2078	12	100	020787
V2079	13	100	020794

$\frac{1}{2}$ " Screwdriver socket for inside hexagon \odot

$\frac{1}{2}$ " Innensechskant Schraubendreher-Einsatz \odot



$\frac{1}{2}$ "



VIGOR No.	Sizes (mm) SW (mm)	mm	EAN 4047728+
V2080	5	140	020800
V2081	6	140	020817
V2082	7	140	020824
V2083	8	140	020831
V2084	10	140	020848
V2085	12	140	020855
V2086	14	140	020862

$\frac{1}{2}$ " Screwdriver socket for inside hexagon \odot

$\frac{1}{2}$ " Innensechskant Schraubendreher-Einsatz \odot



$\frac{1}{2}$ "



VIGOR No.	Sizes (mm) SW (mm)	mm	EAN 4047728+
V2087	5	200	020879
V2088	6	200	020886
V2089	7	200	020893
V2090	8	200	020909
V2091	10	200	020916
V2092	12	200	020923

$\frac{1}{2}$ " Screwdriver socket for screws with internal serration (XZN) \odot

$\frac{1}{2}$ " Innenvielzahn Schraubendreher-Einsatz (XZN) \odot



$\frac{1}{2}$ "



VIGOR No.	Sizes (mm) SW (mm)	mm	EAN 4047728+
V2094	M5	55	020947
V2095	M6	55	020954
V2096	M8	55	020961
V2097	M9	55	020978
V2098	M10	55	020985
V2099	M12	55	020992
V2065	M14	55	020657
V2100	M16	55	021005

$\frac{1}{2}$ " Screwdriver socket for screws with internal serration (XZN) \odot

$\frac{1}{2}$ " Innenvielzahn Schraubendreher-Einsatz (XZN) \odot



$\frac{1}{2}$ "



VIGOR No.	Sizes (mm) SW (mm)	mm	EAN 4047728+
V2066	M5	100	020664
V2068	M6	100	020688
V2067	M8	100	020671
V2113	M9	100	021135
V2059	M10	100	020596
V2060	M12	100	020602
V2121	M14	100	021210

$\frac{1}{2}$ " Screwdriver socket for screws with internal serration (XZN) \odot

$\frac{1}{2}$ " Innenvielzahn Schraubendreher-Einsatz (XZN) \odot



$\frac{1}{2}$ "



VIGOR No.	Sizes (mm) SW (mm)	mm	EAN 4047728+
V2122	M5	140	021227
V2124	M6	140	021241
V2123	M8	140	021234
V2126	M9	140	021265
V2128	M10	140	021289
V2129	M12	140	021296
V2132	M14	140	021326

$\frac{1}{2}$ " Screwdriver socket for screws with internal serration (XZN) \odot

$\frac{1}{2}$ " Innenvielzahn Schraubendreher-Einsatz (XZN) \odot



$\frac{1}{2}$ "



VIGOR No.	Sizes (mm) SW (mm)	mm	EAN 4047728+
V2133	M8	200	021333
V2134	M10	200	021340
V2135	M12	200	021357
V2137	M14	200	021371

$12\frac{5}{16}$ TORX® screwdriver socket

$12\frac{5}{16}$ TORX® Schraubendreher-Einsatz



VIGOR No.	Sizes (mm) SW (mm)	mm	EAN 4047728+
V2151	T 20	55	021517
V2152	T 25	55	021524
V2153	T 27	55	021531
V2154	T 30	55	021548
V2155	T 40	55	021555
V2156	T 45	55	021562
V2157	T 50	55	021579
V2158	T 55	55	021586
V2159	T 60	55	021593
V2160	T 70	55	021609

$12\frac{5}{16}$ TORX® screwdriver socket

$12\frac{5}{16}$ TORX® Schraubendreher-Einsatz



VIGOR No.	Sizes (mm) SW (mm)	mm	EAN 4047728+
V2161	T 20	100	021616
V2162	T 25	100	021623
V2163	T 27	100	021630
V2165	T 30	100	021654
V2167	T 40	100	021678
V2168	T 45	100	021685
V2169	T 50	100	021692
V2170	T 55	100	021708
V2171	T 60	100	021715
V2172	T 70	100	021722

$12\frac{5}{16}$ TORX® screwdriver socket

$12\frac{5}{16}$ TORX® Schraubendreher-Einsatz



VIGOR No.	Sizes (mm) SW (mm)	mm	EAN 4047728+
V2173	T 40	140	021739
V2174	T 45	140	021746
V2175	T 50	140	021753
V2176	T 55	140	021760
V2177	T 60	140	021777
V2178	T 70	140	021784

$12\frac{5}{16}$ TORX® screwdriver socket

$12\frac{5}{16}$ TORX® Schraubendreher-Einsatz



VIGOR No.	Sizes (mm) SW (mm)	mm	EAN 4047728+
V2179	T 40	200	021791
V2180	T 45	200	021807
V2181	T 50	200	021814
V2182	T 55	200	021821
V2183	T 60	200	021838
V2184	T 70	200	021845

$12\frac{5}{16}$ RIBE screwdriver socket

$12\frac{5}{16}$ RIBE Schraubendreher-Einsatz



VIGOR No.	Sizes (mm) SW (mm)	mm	EAN 4047728+
V2202	M5	55	022026
V2203	M6	55	022033
V2204	M7	55	022040
V2205	M8	55	022057
V2206	M9	55	022064
V2207	M10	55	022071
V2208	M12	55	022088
V2209	M13	55	022095
V2210	M14	55	022101

$12\frac{5}{16}$ RIBE screwdriver socket

$12\frac{5}{16}$ RIBE Schraubendreher-Einsatz



VIGOR No.	Sizes (mm) SW (mm)	mm	EAN 4047728+
V2211	M5	100	022118
V2212	M6	100	022125
V2213	M7	100	022132
V2214	M8	100	022149
V2215	M9	100	022156
V2216	M10	100	022163
V2217	M12	100	022170
V2218	M13	100	022187
V2219	M14	100	022194

$12\frac{5}{16}$ RIBE screwdriver socket

$12\frac{5}{16}$ RIBE Schraubendreher-Einsatz



VIGOR No.	Sizes (mm) SW (mm)	mm	EAN 4047728+
V2220	M8	140	022200
V2221	M9	140	022217
V2222	M10	140	022224
V2223	M10.3	140	022231
V2224	M12	140	022248
V2225	M13	140	022255
V2226	M14	140	022262

$12\frac{5}{16}$ RIBE screwdriver socket

$12\frac{5}{16}$ RIBE Schraubendreher-Einsatz



VIGOR No.	Sizes (mm) SW (mm)	mm	EAN 4047728+
V2227	M8	200	022279
V2228	M9	200	022286
V2229	M10	200	022293
V2230	M10.3	200	022309
V2231	M12	200	022316
V2232	M13	200	022323
V2233	M14	200	022330

Socket Systems $12\frac{5}{16}$ 1/2"

Steckschlüssel-Systeme $12\frac{5}{16}$ 1/2"



$12\frac{5}{16}$ 1/2 TORX® screwdriver socket

$12\frac{5}{16}$ 1/2 TORX® Schraubendreher-Einsatz



VIGOR No.	Sizes (mm) SW (mm)	mm	EAN 4047728+
V2200	T 55 H	55	022002



$12\frac{5}{16}$ 1/2 Sliding T-handle

$12\frac{5}{16}$ 1/2 Gleitgriff



VIGOR No.	mm	EAN 4047728+
V2573	250	025737

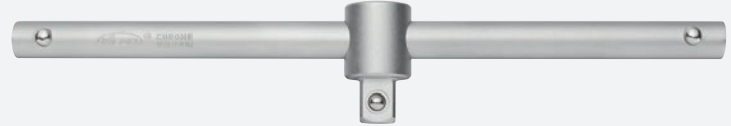

$12\frac{5}{16}$ 1/2 10 3/8 Sliding piece

$12\frac{5}{16}$ 1/2 10 3/8 Gleitstück

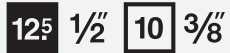

VIGOR No.	mm	EAN 4047728+
V2667	43.7	026673



$12\frac{5}{16}$ 1/2 $12\frac{5}{16}$ 1/2 Universal joint

$12\frac{5}{16}$ 1/2 $12\frac{5}{16}$ 1/2 Universalgelenk



VIGOR No.	mm	EAN 4047728+
V2575	75	025751



$12\frac{5}{16}$ 1/2 $12\frac{5}{16}$ 1/2 Extension

$12\frac{5}{16}$ 1/2 $12\frac{5}{16}$ 1/2 Verlängerung



VIGOR No.	mm	EAN 4047728+
V2576	125	025768
V2577	250	025775



$12\frac{5}{16}$ 1/2 LED extension

$12\frac{5}{16}$ 1/2 LED-Verlängerung



VIGOR No.	mm	EAN 4047728+
V1131	60	011310



Incl. $\square\square\square$ 1.5 V
(LR 44) – 180 mAh
Inkl. $\square\square\square$ 1.5 V
(LR 44) – 180 mAh

10 3/8 $12\frac{5}{16}$ 1/2 Adapter

10 3/8 $12\frac{5}{16}$ 1/2 Adapter

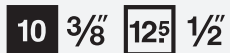

VIGOR No.	mm	EAN 4047728+
V2109	36	021098



20 3/4 $12\frac{5}{16}$ 1/2 Adapter

20 3/4 $12\frac{5}{16}$ 1/2 Adapter

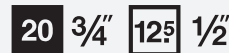

VIGOR No.	mm	EAN 4047728+
V2110	45.5	021104



$12\frac{5}{16}$ 1/2 Bit adapter to $\textcircled{8}$ 5/16

$12\frac{5}{16}$ 1/2 Bit-Adapter auf $\textcircled{8}$ 5/16

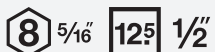

VIGOR No.	mm	EAN 4047728+
V2647	37	026475



$12\frac{5}{8}$ 1/2" Extractor socket with spiral profile

$12\frac{5}{8}$ 1/2" Spiralnutenausdreher-Einsatz

$12\frac{5}{8}$ 1/2"



VIGOR No.	Sizes (mm) SW (mm)	mm	EAN 4047728+
V2405	10	34	024051
V2402	11	34	024020
V2406	12	34	024068
V2407	13	34	024075
V2401	14	34	024013
V2408	15	34	024082
V2403	16	34	024037
V2409	17	34	024099
V2410	19	34	024105
V3742	21	34	037426
V3743	22	34	037433
V3744	24	34	037440
V3745	27	34	037457
V3746	30	34	037464
V3747	32	34	037471

Screw extractor set

V3737, EAN 4047728037372

- With hexagon drive size 13 mm
- Slightly tapered spiral
- Suitable for torn off screws and stud bolts
- Collar guarantees locking effect and spreading limit
- Special steel
- In sturdy plastic box

Contents:

- Extractors 3.2 mm = 1/8" 4.8 mm = 3/16" 6.3 mm = 1/4" 10 mm = 3/8" 12.5 mm = 1/2"
- Extractors 3 · 4 · 5 · 5.5 · 6 · 8 · 10 · 11 · 12 · 14 mm

Schraubenausdreher-Satz

V3737, EAN 4047728037372

- Mit 6-kant-Antrieb SW 13 mm
- Leicht konisch zulaufende Spirale
- Gut geeignet für abgerissene Schrauben und Stehbolzen
- Kontereffekt und Aufspreizbegrenzung durch Bund gewährleistet
- Spezialstahl
- Im stabilen Kunststoffkasten

Inhalt:

- Ausdreher 3.2 mm = 1/8" 4.8 mm = 3/16" 6.3 mm = 1/4" 10 mm = 3/8" 12.5 mm = 1/2"
- Ausdreher 3 · 4 · 5 · 5.5 · 6 · 8 · 10 · 11 · 12 · 14 mm



Extra short style
Extra kurze Ausführung



Socket Systems $12\frac{5}{8}$ 1/2"

Steckschlüssel-Systeme $12\frac{5}{8}$ 1/2"



$12\frac{5}{8}$ 1/2 VDE reversible ratchet
 $12\frac{5}{8}$ 1/2 VDE-Umschaltknarre



VIGOR No.	mm	EAN 4047728+
V3342	255	033428

$12\frac{5}{8}$ 1/2"



$12\frac{5}{8}$ 1/2 VDE socket ●
 $12\frac{5}{8}$ 1/2 VDE-Steckschlüssel-Einsatz ●



VIGOR No.	Sizes (mm) SW (mm)	mm	EAN 4047728+
V3330	8	55	033305
V3331	10	55	033312
V3332	12	55	033329
V3333	13	55	033336
V3334	14	55	033343
V3335	17	55	033350
V3336	19	55	033367
V3337	22	55	033374
V3338	24	55	033381



$12\frac{5}{8}$ 1/2 VDE Screwdriver socket ○
 $12\frac{5}{8}$ 1/2 VDE-Schraubendreher-Einsatz ○



VIGOR No.	Sizes (mm) SW (mm)	mm	EAN 4047728+
V3339	5	78	033398
V3344	6	78	033442
V3340	8	78	033404



$12\frac{5}{8}$ 1/2 $12\frac{5}{8}$ 1/2 VDE extension
 $12\frac{5}{8}$ 1/2 $12\frac{5}{8}$ 1/2 VDE-Verlängerung

$12\frac{5}{8}$ 1/2" $12\frac{5}{8}$ 1/2"

VIGOR No.	mm	EAN 4047728+
V3341	125	033411

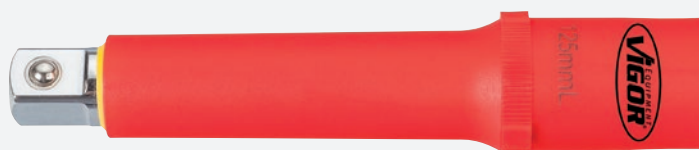



$20 \frac{3}{4}$ Socket set
V2318, EAN 4047728023184

$20 \frac{3}{4}$ Steckschlüssel-Satz
V2318, EAN 4047728023184



Single parts see page 63
 Einzelteilaufistung Seite 63

	Design Ausführung	Sizes (mm) / $\frac{1}{16}$ " SW (mm) / mm
16 x		19 · 21 · 22 · 23 · 24 · 26 · 27 · 28 · 30 32 · 34 · 36 · 38 · 41 · 46 · 50 mm
1 x		100 mm
1 x		100 mm
2 x		200 · 400 mm
1 x		450 mm

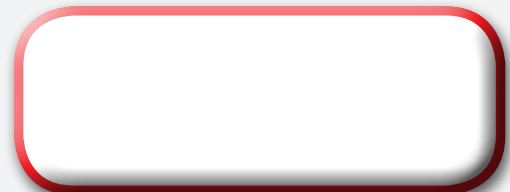

Socket Systems $20 \frac{3}{4}$ "

Steckschlüssel-Systeme $20 \frac{3}{4}$ "



$20 \frac{3}{4}$ Socket \circ

$20 \frac{3}{4}$ Steckschlüssel-Einsatz \circ



VIGOR No.	Sizes (mm) SW (mm)	mm	EAN 4047728+
V2323	19	50	023238
V2324	21	50	023245
V2325	22	50	023252
V2326	23	50	023269
V2327	24	50	023276
V2328	26	50	023283
V2329	27	52	023290
V2256	28	52	022569
V2330	30	54	023306
V2331	32	56	023313
V2332	34	58	023320
V2333	36	58	023337
V2334	38	60	023344
V2337	41	64	023375
V2336	46	68	023368
V2335	50	68	023351

$12^5 \frac{1}{2}$ $20 \frac{3}{4}$ Adapter

$12^5 \frac{1}{2}$ $20 \frac{3}{4}$ Adapter

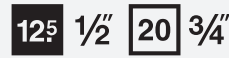

VIGOR No.	mm	EAN 4047728+
V2111	21	021111



$20 \frac{3}{4}$ $20 \frac{3}{4}$ Extension

$20 \frac{3}{4}$ $20 \frac{3}{4}$ Verlängerung

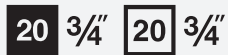

VIGOR No.	mm	EAN 4047728+
V2320	100	023207
V2321	200	023214
V2317	400	023177



$20 \frac{3}{4}$ Sliding T-handle

$20 \frac{3}{4}$ Gleitgriff



VIGOR No.	mm	EAN 4047728+
V2322	450	023221



$20 \frac{3}{4}$ Reversible ratchet

$20 \frac{3}{4}$ Umschaltknarre



VIGOR No.	mm	EAN 4047728+
V2319	100	023191

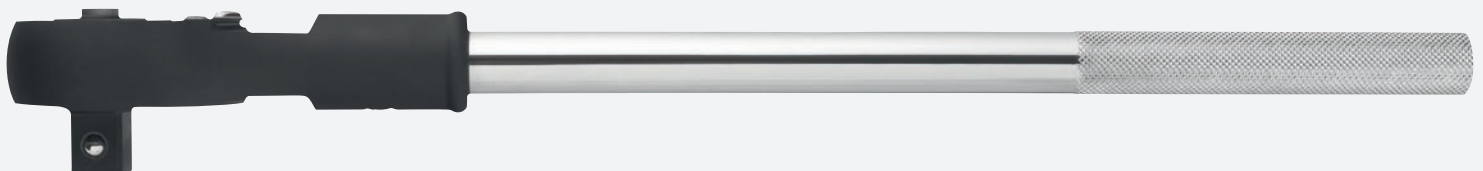

25 T Socket set
V3278, EAN 4047728032780



25 T Steckschlüssel-Satz
V3278, EAN 4047728032780

25 1"

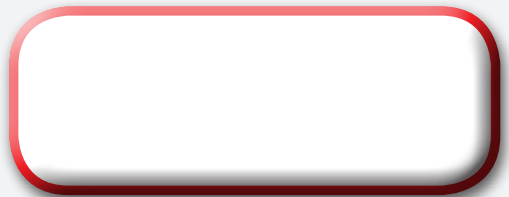

	Design Ausführung		Sizes (mm) / SW (mm) / mm
6 x		25 T	50 · 55 · 60 · 65 · 70 · 80 mm
2 x		25 T	200 · 400 mm
1 x		25 T	170 mm
1 x		25 T	500 mm
1 x		25 T	—

Single parts see page 65
Einzelteilaufistung Seite 65



Socket Systems 25 1" Steckschlüssel-Systeme 25 1"



25 1" 12-point socket

25 1" Doppel-Sechskant Steckschlüssel-Einsatz



VIGOR No.	Sizes (mm) SW (mm)	mm	EAN 4047728+
V3375	50	75	033756
V3376	55	80	033763
V3377	60	85	033770
V3378	65	87	033787
V3379	70	93	033794
V3380	80	103	033800

25 1" Sliding piece

25 1" Gleitstück

25 1"



VIGOR No.	EAN 4047728+
V3373	033732

25 1" 25 1" Extension

25 1" 25 1" Verlängerung

25 1" 25 1"

VIGOR No.	mm	EAN 4047728+
V3280	200	032803
V3371	400	033718



25 1" Sliding T-handle

25 1" Gleitgriff

25 1"

VIGOR No.	mm	EAN 4047728+
V3374	500	033749



25 1" Reversible ratchet

25 1" Umschaltknarre

25 1"

VIGOR No.	mm	EAN 4047728+
V3372	170	033725





6.3 1/4 10 3/8 125 1/2 Socket set
V3277, EAN 4047728032773

6.3 1/4 10 3/8 125 1/2 Steckschlüssel-Satz
V3277, EAN 4047728032773



6.3 1/4 10 3/8 125 1/2

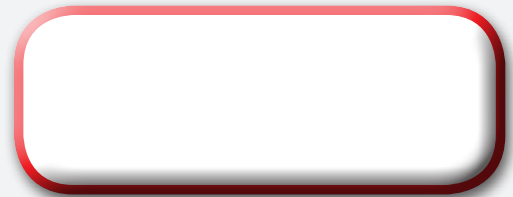
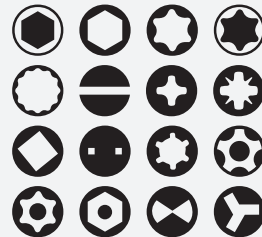

X	Design Ausführung	■	Sizes (mm) / SW (mm) / mm
12 x		—	8 · 9 · 10 · 11 · 12 · 13 · 14 · 15 17 · 19 · 22 · 24 mm
13 x		6.3 1/4	4 · 4.5 · 5 · 5.5 · 6 · 7 · 8 · 9 · 10 11 · 12 · 13 · 14 mm
7 x		6.3 1/4	4 · 5 · 6 · 7 · 8 · 9 · 10 mm
5 x		6.3 1/4	E 4 · E 5 · E 6 · E 7 · E 8
4 x		6.3 1/4	3 · 4 · 5 · 6 mm
4 x		6.3 1/4	0.8 x 4 · 1 x 5.5 · 1.2 x 6.5 · 1.2 x 7 mm
3 x		6.3 1/4	PH 0 · PH 1 · PH 2
3 x		6.3 1/4	PZ 0 · PZ 1 · PZ 2
8 x		6.3 1/4	T 8 · T 9 · T 10 · T 15 · T 20 · T 25 · T 27 · T 30
8 x		6.3 1/4	T 8 H · T 9 H · T 10 H · T 15 H · T 20 H T 25 H · T 27 H · T 30 H
2 x		6.3 1/4	50 100 mm
1 x		6.3 1/4	150 mm
1 x		6.3 1/4	205 mm
1 x		6.3 1/4	150 mm
1 x		6.3 1/4	110 mm
1 x		6.3 1/4	40 mm
1 x		6.3 1/4	30 mm
7 x		6.3 1/4	1.27 · 1.5 · 2 · 2.5 · 3 · 4 · 5 mm
1 x		10 3/8	18 mm
1 x		10 3/8	198 mm
2 x		10 3/8	30 · 56 mm
1 x		10 3/8	30 mm
6 x		10 3/8	E 10 · E 11 · E 12 · E 14 · E 16 · E 18
10 x		10 3/8	10 · 11 · 12 · 13 · 14 · 15 · 16 · 17 · 18 · 19 mm
6 x		10 3/8	10 · 11 · 12 · 13 · 14 · 15 mm
1 x		10 3/8	125 mm
1 x		10 3/8	—
14 x		125 1/2	13 · 14 · 15 · 16 · 17 · 18 · 19 · 20 · 21 · 22 · 24 · 27 · 30 · 32 mm

X	Design Ausführung	■	Sizes (mm) / SW (mm) / mm
5 x		125 1/2	16 · 17 · 18 · 19 · 22 mm
3 x		125 1/2	E 20 · E 22 · E 24
1 x		125 1/2	T 70
1 x		125 1/2	14 mm
2 x		125 1/2	16 · 21 mm
1 x		125 1/2	75 mm
2 x		125 1/2	125 · 250 mm
1 x		125 1/2	— 250 mm
1 x		125 1/2	—
3 x		6.3 1/4	M 5 · M 6 · M 8
6 x		6.3 1/4	2 · 2.5 · 3 · 4 · 5 · 6 mm
3 x		6.3 1/4	T 5 · T 6 · T 7
1 x		6.3 1/4	T 7 H
5 x		6.3 1/4	M 5 · M 6 · M 7 · M 8 · M 9
8 x		6.3 1/4	T 10 H · T 15 H · T 20 H · T 25 H T 27 H · T 30 H · T 40 H · T 45 H
4 x		6.3 1/4	0 · 1 · 2 · 3 mm
3 x		6.3 1/4	6 · 8 · 10 mm
4 x		6.3 1/4	1 · 2 · 3 · 4 mm
3 x		6.3 1/4	1 · 2 · 3 mm
4 x		6.3 1/4	4 · 6 · 8 · 10 mm
4 x		8 9/16	7 · 8 · 10 · 12 mm
3 x		8 9/16	8 · 10 · 12 mm
3 x		8 9/16	PH 2 · PH 3 · PH 4
3 x		8 9/16	PZ 2 · PZ 3 · PZ 4
5 x		8 9/16	T 40 · T 45 · T 50 · T 55 · T 60
5 x		8 9/16	T 40 H · T 45 H · T 50 H · T 55 H · T 60 H
4 x		8 9/16	M 10 · M 11 · M 12 · M 13
2 x		8 9/16	M 10 · M 12
1 x		8 9/16	50 mm

Single parts from page 44 on
 Einzelteillaufistung ab Seite 44

Socket Systems Steckschlüssel-Systeme



6.3 1/4 10 3/8 125 1/2 Socket set
V2461, EAN 4047728024617

6.3 1/4 10 3/8 125 1/2 Steckschlüssel-Satz
V2461, EAN 4047728024617



6.3 1/4 10 3/8 125 1/2

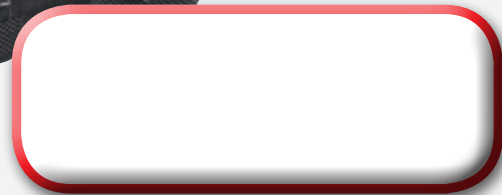

	Design Ausführung		Sizes (mm) / SW (mm) / mm
13 x		6.3 1/4	4 · 4.5 · 5 · 5.5 · 6 · 7 · 8 · 9 · 10 11 · 12 · 13 · 14 mm
7 x		6.3 1/4	4 · 5 · 6 · 7 · 8 · 9 · 10 mm
5 x		6.3 1/4	E 4 · E 5 · E 6 · E 7 · E 8
4 x		6.3 1/4	3 · 4 · 5 · 6 mm
4 x		6.3 1/4	0.8 x 4 · 1 x 5 · 1.2 x 6.5 · 1.2 x 7 mm
3 x		6.3 1/4	PH 0 · PH 1 · PH 2
3 x		6.3 1/4	PZ 0 · PZ 1 · PZ 2
8 x		6.3 1/4	T 8 · T 9 · T 10 · T 15 · T 20 · T 25 · T 27 · T 30
8 x		6.3 1/4	T 8 H · T 9 H · T 10 H · T 15 H · T 20 H T 25 H · T 27 H · T 30 H
1 x		6.3 1/4	50 mm
1 x		6.3 1/4	100 mm
1 x		6.3 1/4	150 mm
1 x		6.3 1/4	150 mm
1 x		6.3 1/4	110 mm
1 x		6.3 1/4	38 mm
1 x		6.3 1/4	30 mm
3 x		6.3 1/4	5 · 6 · 8 mm
5 x		6.3 1/4	5 · 6 · 7 · 8 · 9 mm
3 x		6.3 1/4	T 5 · T 6 · T 7
9 x		6.3 1/4	T 7 H · T 10 H · T 15 H · T 20 H · T 25 H T 27 H · T 30 H · T 40 H · T 45 H
10 x		10 3/8	10 · 11 · 12 · 13 · 14 · 15 · 16 · 17 · 18 · 19 mm
6 x		10 3/8	10 · 11 · 12 · 13 · 14 · 15 mm

	Design Ausführung		Sizes (mm) / SW (mm) / mm
1 x		10 3/8	18 mm
6 x		10 3/8	E 10 · E 11 · E 12 · E 14 · E 16 · E 18
1 x		10 3/8	198 mm
1 x		10 3/8	56 mm
1 x		10 3/8	30 mm
3 x		8 9/16	8 · 10 · 12 mm
5 x		8 9/16	7 · 8 · 10 · 12 · 14 mm
2 x		8 9/16	PH 3 · PH 4
2 x		8 9/16	PZ 3 · PZ 4
6 x		8 9/16	T 40 · T 45 · T 50 · T 55 · T 60 · T 70
6 x		8 9/16	T 40 H · T 45 H · T 50 H · T 55 H · T 60 H · T 70 H
1 x		10 3/8	125 mm
17 x		125 1/2	10 · 11 · 12 · 13 · 14 · 15 · 16 · 17 · 18 19 · 20 · 21 · 22 · 24 · 27 · 30 · 32 mm
5 x		125 1/2	16 · 17 · 18 · 19 · 22 mm
2 x		125 1/2	E 20 · E 22
2 x		125 1/2	16 · 21 mm
1 x		125 1/2	75 mm
2 x		125 1/2	125 · 250 mm
1 x		10 3/8	—
1 x		125 1/2	—
1 x		125 1/2	258 mm
7 x		125 1/2	1.27 · 1.5 · 2 · 2.5 · 3 · 4 · 5 mm

Single parts from page 44 on
Einzelteilaufistung ab Seite 44



Socket set
V1706, EAN 4047728017060

Steckschlüssel-Satz
V1706, EAN 4047728017060



6.3 1/4" **125** 1/2" **8** 5/16"



	Design Ausführung		Sizes (mm) / SW (mm) / mm
13 x			4 · 4.5 · 5 · 5.5 · 6 · 7 · 8 · 9 · 10 · 11 · 12 · 13 · 14 mm
8 x			6 · 7 · 8 · 9 · 10 · 11 · 12 · 13 mm
4 x			3 · 4 · 5 · 6 mm
3 x			0.8 x 4 · 1 x 5.5 · 1.2 x 7 mm
2 x			PH 1 · PH 2
2 x			PZ 1 · PZ 2
6 x			T 8 · T 10 · T 15 · T 20 · T 25 · T 30
1 x			50 mm
2 x			100 · 145 mm
1 x		—	150 mm
1 x		—	150 mm
1 x		—	110 mm
1 x			38 mm
1 x			30 mm

	Design Ausführung		Sizes (mm) / SW (mm) / mm
18 x			10 · 11 · 12 · 13 · 14 · 15 · 16 · 17 · 18 · 19 · 20 · 21 · 22 · 23 · 24 · 27 · 30 · 32 mm
4 x			14 · 15 · 17 · 19 mm
2 x			16 · 21 mm
1 x			75 mm
2 x			125 · 250 mm
1 x			—
1 x			—
1 x			258 mm
3 x			8 · 10 · 12 mm
4 x			8 · 10 · 12 · 14 mm
2 x			PH 3 · PH 4
2 x			PZ 3 · PZ 4
4 x			T 40 · T 45 · T 50 · T 55
3 x		—	1.5 ,5 mm

Single parts from page 44 on
Einzelteilaufistung ab Seite 44

Socket Systems Steckschlüssel-Systeme



TORX® socket set
V2687, EAN 4047728026871

TORX® Steckschlüssel-Satz
V2687, EAN 4047728026871



6.3 1/4 10 3/8 12⁵ 1/2



X	Design Ausführung	■	Sizes (mm) SW (mm)
7 x		6.3 1/4	E 4 · E 5 · E 6 · E 7 · E 8 · E 10 · E 11
12 x		10 3/8	E 4 · E 5 · E 6 · E 7 · E 8 · E 10 · E 11 E 12 · E 14 · E 16 · E 18 · E 20

X	Design Ausführung	■	Sizes (mm) SW (mm)
9 x		12 ⁵ 1/2	E 10 · E 11 · E 12 · E 14 · E 16 · E 18 · E 20 · E 22 · E 24

Single parts from page 44 on
Einzelteilaufistung ab Seite 44

TORX® socket set
V1781, EAN 4047728017817

TORX® Steckschlüssel-Satz
V1781, EAN 4047728017817



6.3 1/4 10 3/8 12⁵ 1/2



X	Design Ausführung	■	Sizes (mm) SW (mm)
5 x		6.3 1/4	E 4 · E 5 · E 6 · E 7 · E 8
7 x		6.3 1/4	T 8 · T 10 · T 15 · T 20 · T 25 · T 27 · T 30
6 x		6.3 1/4	T 10 H · T 15 H · T 20 H · T 25 H · T 25 H · T 30 H
4 x		10 3/8	E 10 · E 12 · E 14 · E 16
4 x		10 3/8	T 40 · T 45 · T 47 · T 50
3 x		10 3/8	T 40 H · T 45 H · T 50 H

X	Design Ausführung	■	Sizes (mm) SW (mm)
2 x		12 ⁵ 1/2	E 18 · E 20
2 x		12 ⁵ 1/2	T 55 · T 60
1 x		12 ⁵ 1/2	T 55 H

Single parts from page 44 on
Einzelteilaufistung ab Seite 44

Fine-tooth reversible ratchet set
V1039, EAN 4047728010399
• DIN 3122 / ISO 3315

Feinzahn-Umschaltknarren-Satz
V1039, EAN 4047728010399
• DIN 3122 / ISO 3315



6.3 1/4" **12⁵** 1/2"

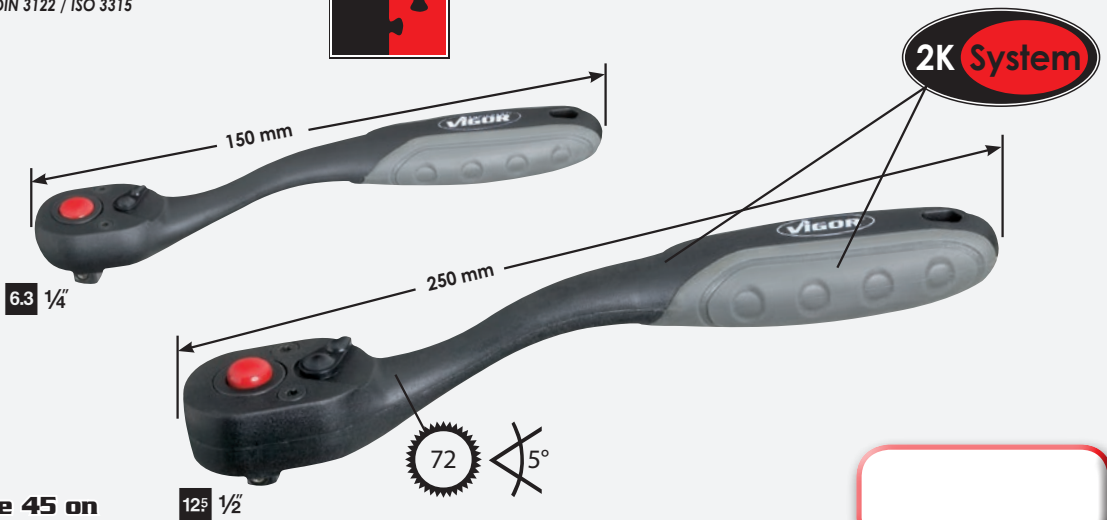

Single parts from page 45 on
Einzelteilaufistung ab Seite 45



Fine-tooth reversible ratchet set
V3081, EAN 4047728030816
• DIN 3122 / ISO 3315

Feinzahn-Umschaltknarren-Satz
V3081, EAN 4047728030816
• DIN 3122 / ISO 3315



6.3 1/4" **10** 3/8" **12⁵** 1/2"



Single parts from page 45 on
Einzelteilaufistung ab Seite 45



Adapter set
V1293, EAN 4047728012935
Adapter-Satz
V1293, EAN 4047728012935



Design Ausführung	■					
6 x		6.3 1/4" - 10 3/8"	10 3/8" - 6.3 1/4"	10 3/8" - 12 5/2"	12 5/2" - 10 3/8"	12 5/2" - 20 3/4"
		12 5/2" - 10 3/8"	12 5/2" - 20 3/4"	20 3/4" - 12 5/2"		

Single parts from page 46 on
Einzelteilaufistung ab Seite 46

