



HAZET HINOX® Stainless Steel Tools



SAFETY – HIGH-QUALITY – ENVIRONMENTAL COMPATIBILITY

- ✓ The static charge (peak load) of the **HINOX**®-tools is up to 30% higher in comparison to competitive products
- ✓ The dynamic charge (permanent load) is up to 3 times higher – longer serviceable life
- ✓ **HINOX**® tools are without surface coating – no allergic reactions due to chemical coatings
- ✓ **Made in Germany**



Safety-Insert-System – a missing tool is noticed immediately

Tools made of solid stainless material. All components, e.g. of the reversible ratchet are made of 100% stainless steel: ratchet housing, ratchet wheel, pawl, cover plates, screws, ball (just the shift lever and the handle are made of plastic)

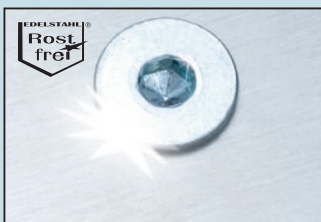
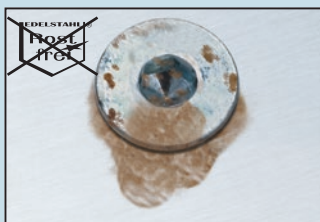
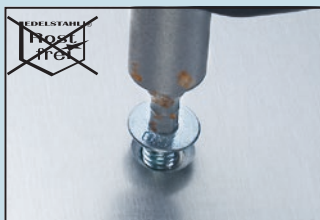

Stainless steel prevents formation of rust!

That means: Only the continuous application of tool, screw, washer, component and nut made of stainless steel ensures a safe rust-proof connection; avoids additional costs or subsequent damage!

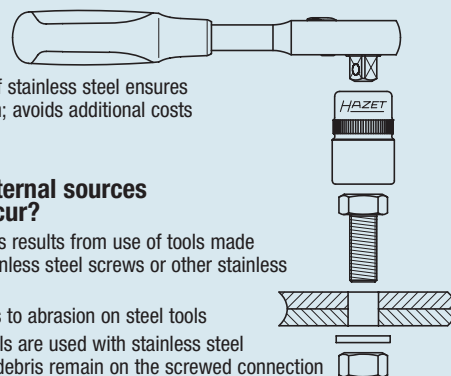

What is rust from external sources and when does it occur?

- Rust from external sources results from use of tools made of standard steel with stainless steel screws or other stainless steel components
- Frequent application leads to abrasion on steel tools
- If these standard steel tools are used with stainless steel components, metal wear debris remain on the screwed connection
- Wear debris and oxygen result in RUST!!

PERMANENT LOAD VALUES HAZET Screwdriver Socket:

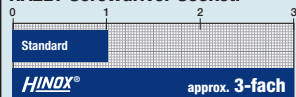

STATIC TORQUE HAZET HAZET Reversible Ratchet:

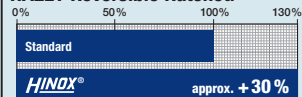

For high-end application in:

- Industry
- Laboratories
- Automotive sector
- Aircraft sector
- Naval construction / shipyards / nautical sector
- In segments of the food industry and medical engineering



HINOX® Stainless Steel Tools

6-Point Socket HINOX®



Safety:

- Up to **20% higher torque values** in the range of HINOX®-tools (static charge)
- Having the same hardness, **high-grade stainless steel** provides better mechanical strength properties than the standard material (31 CrV 3)
- Safer application/reduction of the risk of injury

High quality:

- **Serviceable life up to three times higher** as measured in a continuous load test

Environmental friendliness:

- **Environmentally friendly fabrication:** without surface coating.
- No allergic reactions due to chemical coatings
- Considerably longer serviceable life than comparable competitive products (solid high-grade stainless steel instead of coating)
- Weathering resistant – for outdoor use

Germany Made in Germany

HAZET No.	l mm	d ₁ mm	d ₂ mm	t mm	EAN-No. 4000896+
850 X- 4	25	6.8	11	3.7	121380
850 X- 4.5	25	7	11	4.2	121397
850 X- 5	25	8	11	4.1	121403
850 X- 5.5	25	8.5	11	4.6	121410
850 X- 6	25	9	11	5.1	121427
850 X- 7	25	10.5	11.5	5.6	121533
850 X- 8	25	11.5	12.5	6.3	121540
850 X- 9	25	13	11.5	7.3	121557
850 X-10	25	14	12.5	7.3	121564
850 X-11	25	15.5	14	8.3	121571
850 X-12	25	17	15	9.3	121588
850 X-13	25	18	15	9.3	121595
850 X-14	25	19.5	16	10.8	121601

Screwdriver Socket HINOX®



- □ drive 6.3 = 1/4"
- For **inside hexagon screws**
- With knurling
- For manual operation
- Considerably longer serviceable life than comparable competitive products (solid high-grade stainless steel instead of coating)
- Weathering resistant – for outdoor use

Germany Made in Germany

HAZET No.	S mm	l ₁ mm	l ₂ mm	d mm	EAN-No. 4000896+
8501 X-3	3	6.5	28	12	121618
8501 X-4	4	6.5	28	12	121625
8501 X-5	5	6.5	28	12	121632
8501 X-6	6	6.5	28	12	121649
8501 X-8	8	6.5	28	12	121656



Reversible Ratchet HINOX®



- ■ drive 6.3 = 1/4"
- Ratchet wheel 20 teeth
- Considerably longer serviceable life than comparable competitive products (solid high-grade stainless steel instead of coating)
- Weathering resistant – for outdoor use
- 2-component handle for optimal handling

Germany Made in Germany

HAZET No.	l mm	EAN-No. 4000896+
863 X	115	121335

Replacement set for ratchet wheel HINOX 6.3 = 1/4" ■
 consisting of: ratchet wheel, pawl, shift lever, screws, ball, compression spring for 863 X

863 X/7	-	132997
---------	---	--------

Sliding T-Handle HINOX®



- ■ drive 6.3 = 1/4"
- Considerably longer serviceable life than comparable competitive products (solid high-grade stainless steel instead of coating)
- Weathering resistant – for outdoor use

Germany Made in Germany

HAZET No.	l mm	EAN-No. 4000896+
865 X	115	121342

Spin Type Speeder HINOX®



- ■ drive 6.3 = 1/4"
- TRInamicULTRA handle
- Haptic elements provide a better grip
- Anti-slipping even with oily hands
- Considerably longer serviceable life than comparable products (solid high-grade stainless steel instead of coating)
- Weathering resistant – for outdoor use

Germany Made in Germany

HAZET No.	l mm	EAN-No. 4000896+
866 X	134	121663

Extension HINOX®



- ■ □ drive 6.3 = 1/4"
- Considerably longer serviceable life than comparable competitive products (solid high-grade stainless steel instead of coating)
- Weathering resistant – for outdoor use

Germany Made in Germany

HAZET No.	l mm	EAN-No. 4000896+
867 X-2	55	121366
868 X	147	121359

Universal Joint HINOX®



6.3 1/4"

- ■ □ drive 6.3 = 1/4"
- For screw connections with troublesome borders
- Considerably longer serviceable life than comparable competitive products (solid high-grade stainless steel instead of coating)
- Weathering resistant – for outdoor use

Germany Made in Germany

HAZET No.	l mm	EAN-No. 4000896+
869 X	36.5	121373

Socket Set (6-Point) HINOX®

6.3 1/4"



187 x 125 x 39 mm

- □ drive 6.3 = 1/4"

Safety:

- Up to **20% higher torque values** in the range of HINOX®-tools (static charge)
- Having the same hardness, high-grade stainless steel provides better mechanical strength properties than the standard material (31 CrV 3)
- Safer application/reduction of the risk of injury

High quality:

- **Serviceable life up to three times higher** as measured in a continuous load test

Environmental friendliness:

- **Environmentally friendly fabrication:** without surface coating.
- No allergic reactions due to chemical coatings
- Considerably longer serviceable life than comparable competitive products (solid high-grade stainless steel instead of coating)
- Weathering resistant – for outdoor use

- In plastic box

- With PUR foam insert – all tools are snugly embedded

- **24 pieces**

Germany Made in Germany

Contents:

850 X- 4	4,5	5	5,5	6	7	8
	9	10	11	12	13	14
8501 X-3	4	5	6	8		
863 X	865 X	866 X				
867 X-2	868 X	869 X				

HAZET No.	EAN-No. 4000896+
854 X	121120



HAZET – Range of 6.3 1/4" Sockets

- ✓ Fine-Tooth Reversible Ratchets
- ✓ Reversible Ratchets with T-Handle
- ✓ Reversible Ratchets with Hinge Joint
- ✓ Socket Sets
- ✓ Sockets/Screwdriver Sockets
- ✓ Extensions and many more ...

The "Classic" Reversible Ratchet

2-component handle providing a better grip **2K System**

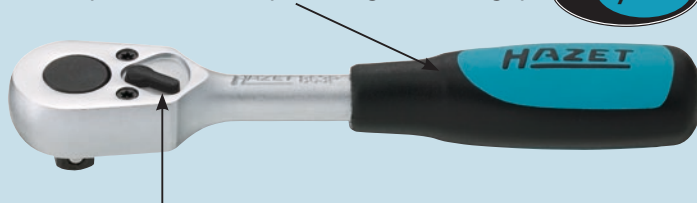

Easy-change shift lever:

1. Use a drift pin to release
2. Insert – click – ready-to-use!
(self-locking)

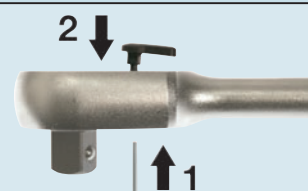

Reversible Ratchet with T-Handle



- ✓ The advantages of a T-handle and a reversible ratchet combined in one tool
- ✓ Also available as Reversible Ratchet for Bits with T-Handle

Short, compact Reversible Ratchet

In compact design only 95 mm short



Sockets 6.3 1/4"



Long style

Socket Sets



product design award

2012

TESTSIEGER MOTORRAD

Testsieger Steckschlüssel-Satz 856-1



Ausgabe 22/2011

6-Point Socket



- □ drive 6.3 = 1/4"
- **With Traction profile**
- With knurling
- For manual operation
- 850-3 not according to DIN
- Surface: chrome-plated, polished
- DIN 3124, ISO 2725-1

Made in Germany

HAZET No.	l mm	d1 mm	d2 mm	t mm	EAN-No. 4000896+
850- 3	25	6.2	11	3.2	057221
850- 4	25	6.8	11	3.7	036370
850- 4.5	25	7.4	11	4.2	036387
850- 5	25	8.1	11	4.1	036400
850- 5.5	25	8.7	11	4.6	036417
850- 6	25	9.3	11	5.1	036479
850- 7	25	10.9	11.5	5.5	036516
850- 8	25	12.1	12.5	6.5	036547
850- 9	25	13.4	12.5	7.5	036585
850-10	25	14.6	12.5	7.3	036202
850-11	25	15.5	14	8.3	036240
850-12	25	17	15	9.3	036271
850-13	25	18	15	9.3	036301
850-14	25	19.5	16	10.8	036349



- **American sizes**
- □ drive 6.3 = 1/4"
- **With Traction profile**
- With knurling
- For manual operation
- Surface: chrome-plated, polished

Made in Germany

HAZET No.	l mm	d1 mm	d2 mm	t mm	EAN-No. 4000896+
850 A-3/16	25	8	11	4.2	037490
850 A-7/32	25	8.5	11	4.6	037537
850 A-1/4	25	9.5	11	5.1	037476
850 A-9/32	25	10.5	11.5	5.6	037551
850 A-5/16	25	11.5	12.5	6.3	037513
850 A-11/32	25	13	11.5	7.3	037483
850 A-3/8	25	14	12.5	7.3	037506
850 A-7/16	25	15.5	14	8.3	037520
850 A-1/2	25	18	15	9.3	037469
850 A-9/16	25	19.5	16	10.8	037544



- Long style
- □ drive 6.3 = 1/4"
- **With Traction profile**
- With knurling
- For manual operation
- Surface: chrome-plated

Made in Germany

HAZET No.	l mm	d1 mm	d2 mm	t mm	EAN-No. 4000896+
850 Lg-4	50	6.7	11	4	037643
850 Lg-5	50	7.9	11	4.2	037650
850 Lg-5.5	50	8.5	11	5	037667
850 Lg-6	50	9.2	11	5.5	037674
850 Lg-7	50	11	11	6	037681
850 Lg-8	50	12	12	8	037698

6-Point Socket

HAZET No.	l mm	d1 mm	d2 mm	t mm	EAN-No. 4000896+
850 Lg- 9	50	13	13	8	037704
850 Lg-10	50	14.5	14.5	9.2	037599
850 Lg-11	50	15.5	15.5	10.7	037605
850 Lg-12	50	17	17	12.2	037612
850 Lg-13	50	18	18	12.2	037629

12-Point Socket



For the operation of the screws at the timing chain cover on e.g. VW 1.2l TSI engines

- Long style
- □ drive 6.3 = 1/4"
- With Traction profile
- With knurling
- For manual operation
- Surface: chrome-plated

Made in Germany

HAZET No.	d1 mm	d2 mm	t mm	l mm	EAN-No. 4000896+
850 TZ-8	12.2	12.2	8	50	177646

TORX® Socket



- □ drive 6.3 = 1/4"
- For **outside TORX® screws**
- With knurling
- For manual operation
- Surface: chrome-plated, polished

Made in Germany

HAZET No.	l mm	d1 mm	d2 mm	mm	EAN-No. 4000896+
850-E 4	25	5.6	11	3.86	036653
850-E 5	25	6.7	11	4.75	036684
850-E 6	25	8	11	5.74	036714
850-E 7	25	9.6	11	6.22	036745
850-E 8	25	10.5	11.5	7.52	036776
850-E 10	25	13	12	9.42	036615
850-E 11	25	14	12.5	10.08	036646

Screwdriver Socket



- □ drive 6.3 = 1/4"
- For **inside hexagon screws**
- With knurling
- For manual operation
- **Surface CVD Titanium Nitride (TIN) coated for**
 - Improved endurance
 - Higher torque values
 - Corrosion resistance
 - Minimization of cam-out effect (better screw grip)

Screwdriver Socket

8501-2.5 esp. for screwing the headliner and cape hood bracing wires, micro-switches, soft top frames **BMW 3-series convertible**

- Surface: CVD-TIN coated
- DIN 7422

Made in Germany

HAZET No.	s mm	l1 mm	l2 mm	d mm	EAN-No. 4000896+
8501-2.5	2.5	6.5	28	12	036837
8501-3	3	6.5	28	12	036851
8501-4	4	6.5	28	12	036875
8501-5	5	6.5	28	12	036899
8501-6	6	6.5	28	12	036912
8501-8	8	6.5	28	12	036936

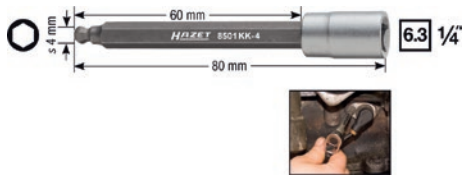

Screwdriver Socket with Ball Head for Speed Sensor

- Installation and removal of the engine speed sensor on **VW**:
 - 1.4 l injection engines (**direct injection engine with turbo charger**): Golf 5, Golf Plus, Touran, Tiguan, Scirocco, Passat
 - 1.4 l injection engines (**direct injection engine with turbo charger and compressor**): Golf 6, Golf Plus, Tiguan, Eos, Scirocco, Touran
- **Blade with ball head** s 4 mm
- □ drive 6.3 = 1/4"

Made in Germany

HAZET No.	s mm	l1 mm	l2 mm	d mm	EAN-No. 4000896+
8501 KK-4	4	60	80	12	157839

TIN coating

Why choose TIN (Titanium-Nitride)-coating?

- ✓ A special coating process for extremely hard TIN coating guarantees high adhesive strength and wear resistance of the coating
- ✓ Particularly suitable for continuous load, e. g. for industrial applications in industry and trade
- ✓ Higher wear protection guarantees a longer lifetime
- ✓ Perfect fitting accuracy through optimum coating thickness
- ✓ Higher torque
- ✓ Optimised corrosion protection

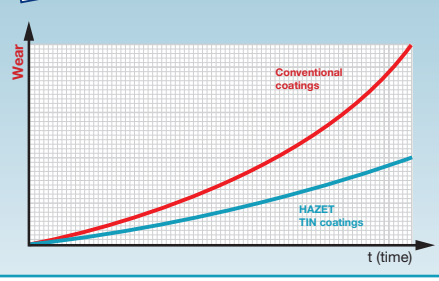
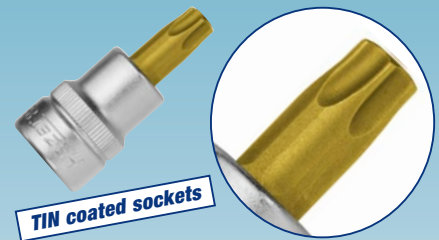



Hand Tools – Range of 6.3 1/4" Sockets

TORX® Screwdriver Socket



- drive 6.3 = 1/4"
- For inside TORX® screws
- With knurling
- For manual operation
- Surface: CVD-TIN coated

Germany Made in Germany

HAZET No.	l ₁ mm	l ₂ mm	d mm	mm	EAN-No. 4000896+
8502-T 8	3.5	28	12	2.31	037124
8502-T 9	3.5	28	12	2.50	037148
8502-T 10	3.8	28	12	2.74	036967
8502-T 15	4	28	12	3.27	036981
8502-T 20	4	28	12	3.86	037001
8502-T 25	4.5	28	12	4.43	037025
8502-T 27	4.5	28	12	4.99	037049
8502-T 30	5	28	12	5.52	037063
8502-T 40	2	28	12	6.65	037100

Screwdriver Socket



- drive 6.3 = 1/4"
- For slotted screws
- With knurling
- For manual operation
- Surface: CVD-TIN coated
- Tip according to ISO 2380-1

Germany Made in Germany

HAZET No.	l ₁ mm	l ₂ mm	d mm	EAN-No. 4000896+
8503-0.6 x 3.5	16	28	12	037162
8503-0.8 x 4	16	28	12	037186
8503-1 x 5.5	16	28	12	037247
8503-1.2 x 8	16	28	12	037209
8503-1.6 x 10	16	28	12	037223



- drive 6.3 = 1/4"
- For Phillips-Recess screws PH
- With knurling
- For manual operation
- Surface: CVD-TIN coated
- Tip according to ISO 8764-1

Germany Made in Germany

HAZET No.	l ₁ mm	l ₂ mm	d mm	EAN-No. 4000896+
8506-PH 1	16	28	12	037285
8506-PH 2	16	28	12	037308
8506-PH 3	16	28	12	037322
8506-PH 4	16	28	12	037346



- drive 6.3 = 1/4"
- For Pozidriv screws PZ
- With knurling
- For manual operation
- Surface: CVD-TIN coated
- Tip according to ISO 8764-1

Germany Made in Germany

Screwdriver Socket

HAZET No.	l ₁ mm	l ₂ mm	d mm	EAN-No. 4000896+
8507-PZ 1	16	28	12	037360
8507-PZ 2	16	28	12	037377
8507-PZ 3	16	28	12	037384

Adapter



- drive 6.3 = 1/4"
- drive 10 = 3/8"
- Surface: chrome-plated
- DIN 3123, ISO 3316

Germany Made in Germany

HAZET No.	l mm	EAN-No. 4000896+
858-1	26.5	038480

Impact Adapter



- drive 6.3 = 1/4" (DIN 3121)
- ISO 1173-A 5.5
- For impact sockets with □ drive 6.3 = 1/4"
- For power screwdrivers, e.g. AEG, Bosch, Metabo

Germany Made in Germany

HAZET No.	l mm	EAN-No. 4000896+
8508 S-1	50	037391



- drive 6.3 = 1/4" (DIN 3121)
- ISO 1173-E 6.3 (1/4")
- For power screwdrivers, e.g. AEG, Atlas-Copco, Black/Decker, Bosch

Germany Made in Germany

HAZET No.	l mm	EAN-No. 4000896+
8508 S-3	50	037414
8508 S-4	100	037421

Flexible Spin Type Speeder



- drive 6.3 = 1/4"
- Flexible shaft enables operation of screw connections with troublesome borders and fast working even in areas with restricted access
- Esp. for worm-drive hose clips in fuel lines and coolant hoses, etc.

Germany Made in Germany

HAZET No.	l mm	EAN-No. 4000896+
870-2	130	050536

Fine-Tooth Reversible Ratchet



The New Generation – part 2

- Solid steel ratchet
- Lowered shift button
- drive 6.3 = 1/4"
- 72 teeth, actuation angle 5° enable working in areas with restricted access
- Large reversing switch on ratchet top simplifies change-over
- Deep-set reversing switch prevents unintentional change-over
- Cover plate and reversing switch suitable for excessive use
- Induction hardened teething guarantee high resistance and a long service life
- Sturdy housing with forged ergonomic handle
- Non-slip 2-component handle for optimal handling
- Surface: chrome-plated

Germany Made in Germany

HAZET No.	l mm	EAN-No. 4000896+
863-1	119	164387

Reversible Ratchet



- drive 6.3 = 1/4"
- Ratchet wheel 20 teeth
- 2-component handle for optimal handling
- Surface: chrome-plated, polished
- DIN 3122, ISO 3315

Germany Made in Germany

HAZET No.	l mm	EAN-No. 4000896+
863 P	115	038558



- drive 6.3 = 1/4"
- With locking device and quick release press button
- Ratchet wheel 20 teeth
- Safe locking of the sockets
- By pressing the button, attached tools are easily released – with just one hand
- 2-component handle for optimal handling
- Surface: chrome-plated, heads polished

Germany Made in Germany

HAZET No.	l mm	EAN-No. 4000896+
863 S	115	038626

Reversible Ratchet



6.3 1/4"

- drive 6.3 = 1/4"
- Curved design for working in areas with restricted access
- Ratchet wheel 20 teeth
- 2-component handle for optimal handling
- Surface: chrome-plated, polished
- DIN 3122, ISO 3315

Made in Germany

HAZET No.	l mm	EAN-No. 4000896+
863 PC	115	038602



6.3 1/4"

- drive 6.3 = 1/4"
- With hinge for working in areas with restricted access
- Ratchet wheel 20 teeth
- 2-component handle for optimal handling
- Surface: chrome-plated, polished
- DIN 3122, ISO 3315

Made in Germany

HAZET No.	l mm	EAN-No. 4000896+
863 G	135	038497

Reversible Ratchet with T-Handle



6.3 1/4"

- drive 6.3 = 1/4"
- The advantages of a T-handle and a reversible ratchet combined in one tool
- Enables either powerful or sensitive working
- With locking device and quick release press button
- Optimal working with extension HAZET 868
- DIN 3122, ISO 3315

HAZET No.	l mm	EAN-No. 4000896+
863 Q	100	063482

Short Reversible Ratchet



95 mm short design, special compact type

- Adjusted to the more and more confined spaces
- drive 6.3 = 1/4"
- Ratchet wheel 20 teeth
- 2-component handle for optimal handling
- Surface: chrome-plated, polished
- DIN 3122, ISO 3315

Short Reversible Ratchet

Made in Germany

HAZET No.	l mm	EAN-No. 4000896+
863 K	95	158218

Short Reversible Ratchet for Bits



95 mm short design, special compact type

- Adjusted to the more and more confined spaces
- For screwdriver bits
- drive 6.3 = 1/4"
- Ratchet wheel 20 teeth
- 2-component handle for optimal handling
- Surface: chrome-plated, polished

Made in Germany

HAZET No.	l mm	EAN-No. 4000896+
863 BK	95	158225

Reversible Ratchet for Bits



- For screwdriver bits
- Surface: chrome-plated, polished
- drive 6.3 = 1/4"
- 20 teeth

Made in Germany

HAZET No.	l mm	EAN-No. 4000896+
2264	115	015887

Repair Set



Made in Germany

HAZET No.	EAN-No. 4000896+
2264	015887

Replacement set for shift lever consisting of: shift lever, pawl, screws, ball, compression spring for 863 K, 863, 863 G, 863 P, 863 PC, 863 Q, 863 S, 863 ST, 863 BGL, 863 BKC, 863 BK, 2264
863 P/6 144600

Replacement set for ratchet wheel 6.3 = 1/4" ■ consisting of: ratchet wheel, pawl, shift lever, screws, ball, compression spring for 863 G, 863 P, 863 PC, 863 ST, 863 K
863 P/7 N 038596

Replacement set for ratchet wheel 6.3 = 1/4" ■ consisting of: ratchet wheel with quick-release press-button, pawl, shift lever, screws, ball, compression spring for 863 Q, 863 S as well as for refitting 863 P, 863 PC, 863 G, 863 ST, 863 K
863 S/7 048472

Replacement set for ratchet wheel 6.3 = 1/4" ○ consisting of: ratchet wheel, pawl, shift lever, screws, ball, compression spring for 863 BGL, 863 BKC, 863 BK, 2264
2264/7 015917

Sliding T-Handle



6.3 1/4"

- drive 6.3 = 1/4"
- Surface: chrome-plated, polished
- DIN 3122, ISO 3315

Made in Germany

HAZET No.	l mm	EAN-No. 4000896+
865	115	038718

Spin Type Speeder



6.3 1/4"

- drive 6.3 = 1/4"
- TRInamicULTRA handle
- Better application of force due to "haptic" elements of the handle
- Anti-slipping even with oily hands
- Surface: matt chrome-plated
- DIN 3122, ISO 3315

Made in Germany

HAZET No.	l mm	EAN-No. 4000896+
866 U	134	056453

Extension



6.3 1/4"

6.3 1/4"

- □ drive 6.3 = 1/4"
- Surface: chrome-plated, polished
- DIN 3123, ISO 3316

Made in Germany

HAZET No.	l mm	EAN-No. 4000896+
867-1	25	038732
867-2	55	038749
867-4	101.5	038770



6.3 1/4"

6.3 1/4"

- □ drive 6.3 = 1/4"
- 868-16: Length not according to DIN
- Surface: chrome-plated, polished
- DIN 3123, ISO 3316

Made in Germany

HAZET No.	l mm	EAN-No. 4000896+
868	147	038794
868-16	402	076727

Universal Joint



6.3 1/4"

- □ drive 6.3 = 1/4"
- For screw connections with troublesome borders
- Surface: chrome-plated

Made in Germany

HAZET No.	l mm	EAN-No. 4000896+
869	36.5	038824



Hand Tools – Range of 6.3 1/4" Sockets

Flexible Extension



- drive 6.3 = 1/4"
- Flexible shaft enables operation of screw connections with troublesome borders and fast working even in areas with restricted access

• Made in Germany

HAZET No.	l mm	EAN-No. 4000896+
870	150	038848

Wobble Extension

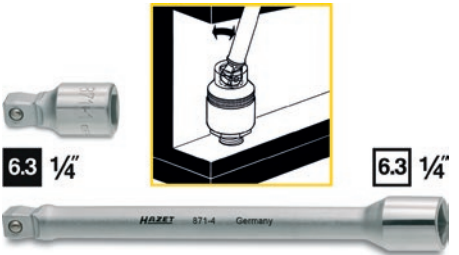

- drive 6.3 = 1/4"
- With ball shaped, conical outside square, allows 8° angular movement to every side
- By attaching a socket until its limit stop is reached, the wobble extension may also be used as rigid extension
- Flexible shaft enables operation of screw connections with troublesome borders and working in areas with restricted access
- Surface: chrome-plated, polished

• Made in Germany

HAZET No.	l mm	EAN-No. 4000896+
871-1	25	038855
871-4	101.5	038879

Metal Socket Rail

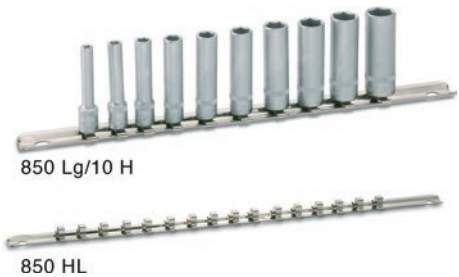

- drive 6.3 = 1/4"
- Easy installation: 2 bore holes, e.g. for wall fixation
- Holding clamps adapted to the drive size
- Clear arrangement – sockets are always ready to hand
- Made of metal

HAZET No.	l mm	EAN-No. 4000896+
10 pcs. 6-point sockets, long style		
Contents:		
850 Lg-4	5 6 7 8 9 10 11 12 13	
850 Lg/10 H	430	051786
Empty, with 16 socket clips suitable for sockets of 850 series		
850 HL	430	037575

Socket Set (6-Point)



167 x 97 x 37 mm

- drive 6.3 = 1/4"
- In plastic box
- With PUR foam insert – all tools are snugly embedded
- 14 pieces

• Made in Germany

Contents:

850-4	4,5	5	5,5	6
	7	8	9	10
863 P	867-2	868	869	

HAZET No.	EAN-No. 4000896+
850-1	036196

TORX® Socket Set

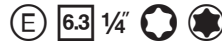

167 x 97 x 37 mm

- drive 6.3 = 1/4"
- With reversible ratchet with T-Handle
- In plastic box
- With PUR foam insert – all tools are snugly embedded
- 20 pieces

Contents:

850-E 4	E 5	E 6	E 7	E 8	E 10	E 11
8502-T	8 T	9 T	10 T	15 T	20 T	25 T
	27 T	30 T	40 T			
863 Q	868	871-4	869			

HAZET No.	EAN-No. 4000896+
850 TQ	072033

Socket Set (6-Point)

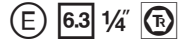

167 x 97 x 37 mm

- drive 6.3 = 1/4"
- In plastic box
- With PUR foam insert – all tools are snugly embedded
- 14 pieces

• Made in Germany

Contents:

850-5	5,5	6	7	8
	9	10	11	12
863 P	867-2	868	869	

HAZET No.	EAN-No. 4000896+
851	038176

Socket Set (6-Point)



187 x 125 x 39 mm

- drive 6.3 = 1/4"
- Screwdriver Bits
- In plastic box
- Safety-Insert-System – 2-component soft foam insert – all tools are snugly embedded
- 36 pieces

• Made in Germany

Contents:

850-5,5	6	7	8	9
	10	11	12	13
	14			
863 P	866 U	867-2	4	
2204-3	4	5	6	7
2208-6	10	11		
2215-PH	1	PH 2	PH 3	
2216-PZ	1	PZ 2	PZ 3	
2223-T	10 H	T 15 H	T 20 H	T 25 H
	T 27 H	T 30 H	T 40 H	
2250-1				

HAZET No.	EAN-No. 4000896+
853-1	154654

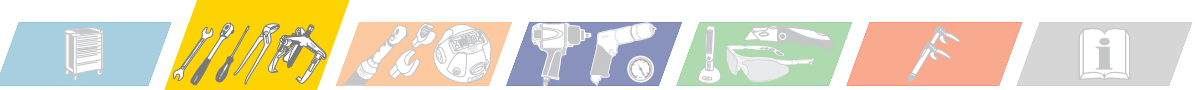

Range of 6.3 1/4" Sockets

Socket Set (6-Point)



187 x 125 x 39 mm

- drive 6.3 = 1/4"
- Additionally with CVD-Titanium Nitride (TIN) coated screwdriver sockets
- In plastic box
- With PUR foam insert - all tools are snugly embedded
- **30 pieces**

Made in Germany

Contents:

- 850-4 5 5,5 6 7 8 9 10 11 12 13 14
- 8501-3 4 5 6 8
- 8503-0,6 x 3,5 1 x 5,5 1,2 x 8
- 8506-PH 1 PH 2
- 8507-PZ 1 PZ 2
- 863 P 865 866 U 867-2 868 869

HAZET No.	EAN-No. 4000896+
854	038336

Socket Set



187 x 125 x 39 mm

- drive 6.3 = 1/4"
- Screwdriver sockets, CVD-Titanium Nitride (TIN) coated
- In plastic box
- With PUR foam insert - all tools are snugly embedded
- **33 pieces**

Made in Germany

Contents:

- 850-5 5,5 6 7 8 9 10 11 12 13 14
- 850-E5 E6 E7 E8 E10
- 8501-3 4 5 6
- 8502-T 10 T 15 T 20 T 25 T 30
- 8503-1 x 5,5 8506-PH 2
- 863 P 871-4 866 U
- 867-2 868 869

HAZET No.	EAN-No. 4000896+
854 T	109579

Screwdriver Bit Set



167 x 97 x 37 mm

36 pieces

Made in Germany

Contents:

- 850-5 5,5 6 7 8 9 10 11 12 13 14
- 2204-2 2,5 3 4 5 6 8
- 2208-4 6 8 10
- 2215-PH 1 PH 2 2216-PZ 1 PZ 2
- 2223-T 10 H T 15 H T 20 H T 25 H T 30 H T 40 H
- 2238-1 2239-3 2264 2304

HAZET No.	EAN-No. 4000896+
2200/36	063734

Socket Set (6-Point)



TESTSIEGER MOTORRAD
Testsieger Stockschlüssel-Satz 856-1
Ausgabe 2/2011

product design award 2012

SmartCase

- New, ergonomic design
- Easy handling, operating tools are ready to hand when needed
- □ drive 6.3 = 1/4"
- In plastic box, black /HAZET-BLUE®
- Dimensions: H 52 mm x W 98 mm x D 180 mm
- **38 pieces**

Made in Germany

Contents:

- 850-5,5 6 7 8 9 10 11 12 13 14
- 863 P 866 U 867-2 4 869
- 2204-3 4 5 6 7 2208-6 10 11
- 2215-PH 1 PH 2 PH 3 2216-PZ 1 PZ 2 PZ 3
- 2223-T 10 H T 15 H T 20 H T 25 H T 27 H T 30 H T 40 H
- 2250-1 2304

HAZET No.	EAN-No. 4000896+
856-1	164813

Socket Set (6-Point)



187 x 126 x 39 mm

- drive 6.3 = 1/4"
- Additionally with CVD-Titanium Nitride (TIN) coated screwdriver sockets
- In plastic box
- With PUR foam insert - all tools are snugly embedded
- **33 pieces**

Made in Germany

Contents:

- 850-4 5 6 7 8 9 10 11 12 13 14
- 8501-3 4 5 6 8
- 8503-0,6 x 3,5 0,8 x 4 1 x 5,5 1,2 x 8
- 8506-PH 1 PH 2 PH 3 PH 4
- 8507-PZ 1 PZ 2 PZ 3
- 863 P 865 866 U 867-2 868 869

HAZET No.	EAN-No. 4000896+
854-1	038343

Socket Set



344 x 188 x 56 mm

- drive 6.3 = 1/4"
- Long and short style sockets
- In plastic box
- In 2-coloured soft foam insert - all tools are snugly embedded
- **Safety-Insert-System** - a missing tool is noticed immediately
- **40 pieces**

Made in Germany

Contents:

- 850-4 4,5 5 6 7 8 9 10 11 12 13
- 850 Lg-5 6 7 8 9 10 11 12 13
- 850-E5 6 7 8 10
- 8501-3 4 5
- 8502-T 10 T 15 T 20 T 25 T 30
- 8503-1 x 5,5 8506-PH 2
- 863 P 866 U 867-2 4 869

HAZET No.	EAN-No. 4000896+
855-1	115983



HAZET – Range of 10 3/8" Sockets

- ✓ Fine-Tooth Reversible Ratchets
- ✓ Reversible Ratchets with Hinge Joint
- ✓ Socket Sets
- ✓ Socket and Screwdriver Sockets
- ✓ Extensions and many more...

The "Classic" Reversible Ratchet

2-component handle providing a better grip

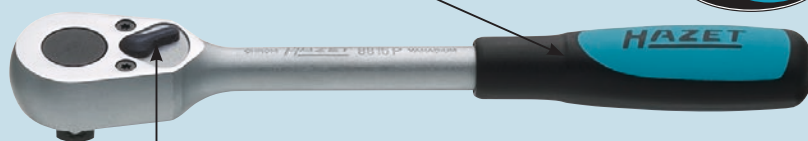

Easy-change shift lever:

1. Use a drift pin to release
2. Insert – click – ready-to-use! (self-locking)

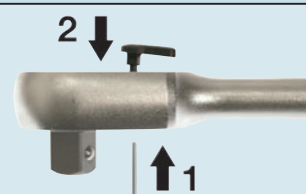

Reversible Ratchet „Long style“

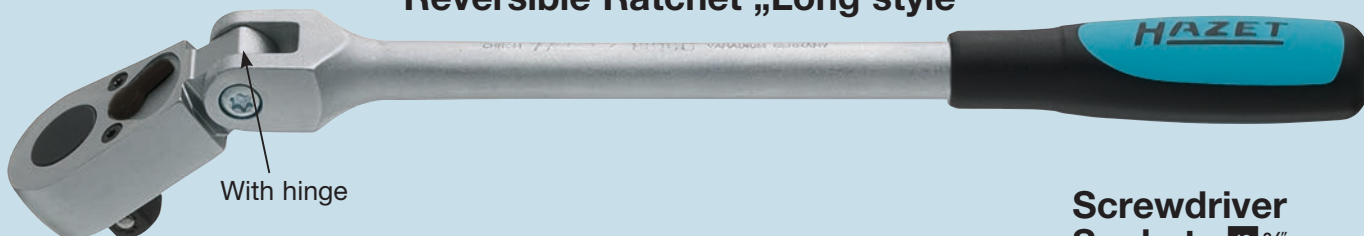

Screwdriver Sockets 10 3/8"

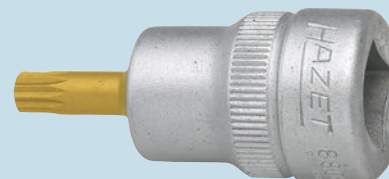

Sockets 10 3/8"



Socket Sets 10 3/8"



6-Point Socket



- drive 10 = 3/8"
- With Traction profile**
- With knurling
- For manual operation
- Surface: chrome-plated, polished
- DIN 3124, ISO 2725-1
- Made in Germany**

* = not according to DIN

HAZET No.	l mm	d ₁ mm	d ₂ mm	t mm	EAN-No. 4000896+
880- 6 *	24	10	17	6.2	039104
880- 7	24	10.5	17	6.2	039111
880- 8	24	11.8	17	6.2	039128
880- 9	24	13	17	6.2	039135
880-10	25	14.4	17	7.2	038893
880-11	26	15.8	17.5	8.2	038916
880-12	27	17	18.5	9.2	038923
880-13	27.5	18.4	17	9.7	038930
880-14	29.5	19.5	17.5	11.7	038947
880-15	29.5	20.9	18	11.7	038954
880-16	29.5	22.1	18	11.7	038961
880-17	29.5	23.3	18.5	11.7	038978
880-18	31.5	24.8	19	13.5	038992
880-19	31.5	25.8	19.5	13.5	039005
880-20	31.5	26.8	21	13.5	039043
880-21	31.5	28.3	22.5	13	039050
880-22	34	29.6	23.5	16	039067

VDE 6-Point Socket



see chapter VDE-/Tools for Electricians page 148

6-Point Socket



- Long style
- drive 10 = 3/8"
- With Traction profile**
- With knurling
- For manual operation
- Surface: chrome-plated, polished
- DIN 3124, ISO 2725-1
- Made in Germany**

HAZET No.	l mm	d ₁ mm	d ₂ mm	t mm	EAN-No. 4000896+
880 Lg- 7	54	10.9	17	7	052240
880 Lg- 8	54	12.1	17	7	052257
880 Lg- 9	54	13	17	10	040858
880 Lg-10	54	14.4	17	10	040698
880 Lg-11	54	15.8	17.2	11	040704
880 Lg-12	54	17	18.5	11	040711
880 Lg-13	54	18.4	18.5	12	040728
880 Lg-14	54	19.5	19.5	15	040759
880 Lg-15	60	20.8	19.5	15	040766
880 Lg-16	60	21.8	18.5	16	040773
880 Lg-17	60	23	18.5	16	040780
880 Lg-18	66	24.4	20	20	040797

6-Point Socket

HAZET No.	l mm	d ₁ mm	d ₂ mm	t mm	EAN-No. 4000896+
880 Lg-19	66	25.5	20	20	040803
880 Lg-20	70	26.6	21	22	040810
880 Lg-21	70	28	22	22	040834
880 Lg-22	70	29.6	21	22	040841

12-Point Socket



- drive 10 = 3/8"
- With Traction profile**
- With knurling
- For manual operation
- Surface: chrome-plated, polished
- DIN 3124, ISO 2725-1
- Made in Germany**

HAZET No.	l mm	d ₁ mm	d ₂ mm	t mm	EAN-No. 4000896+
880 Z- 9	24	13	17	6.2	041985
880 Z-10	25	14.4	17	7.2	041848
880 Z-11	26	15.8	17.5	8.2	041855
880 Z-12	27	17	18.5	9.2	041862
880 Z-13	27.5	18.4	17	9.7	041879
880 Z-14	29.5	19.6	17.5	11.7	041893
880 Z-15	29.5	20.9	18	11.7	041909
880 Z-16	29.5	22.1	18	11.7	041916
880 Z-17	29.5	23.3	18.5	11.7	041923
880 Z-18	31.5	24.6	19	13.5	041930
880 Z-19	31.5	25.8	19.5	13.5	041947
880 Z-20	31.5	26.8	20	13.5	041954
880 Z-21	31.5	28.3	22.5	13	041961
880 Z-22	34	29.6	23.5	15.5	041978

- American sizes**
- drive 10 = 3/8"
- With Traction profile**
- With knurling
- For manual operation
- Sizes 1/4" and 5/16"** with hexagon
- Surface: chrome-plated, polished
- Made in Germany**

HAZET No.	l mm	d ₁ mm	d ₂ mm	EAN-No. 4000896+
880 A- 1/4	24	10	17	040056
880 A- 5/16	24	11.8	17	040094
880 AZ- 3/8	25	13.8	17	040360
880 AZ- 7/16	26	15.8	17.5	040384
880 AZ- 1/2	27.5	18.7	17	040292
880 AZ- 9/16	29.5	20.1	17.5	040407
880 AZ- 19/32	29.5	21.1	18	040339
880 AZ- 5/8	29.5	22.1	18	040377
880 AZ- 11/16	29.5	23.8	18.5	040308
880 AZ- 3/4	31.5	25.8	19.5	040353
880 AZ- 25/32	31.5	26.8	21	040346
880 AZ- 13/16	32	28.3	22.5	040315
880 AZ- 7/8	34	30.3	23.5	040391
880 AZ- 15/16	36.5	32.3	23.5	040322



12-Point Socket

- Long style
- drive 10 = 3/8"
- With Traction profile**
- With knurling
- For manual operation
- Surface: chrome-plated, polished
- DIN 3124, ISO 2725-1
- Made in Germany**

HAZET No.	l mm	d ₁ mm	d ₂ mm	t mm	EAN-No. 4000896+
880 TZ- 9	54	13	17	10	041824
880 TZ-10	54	14.4	17	10	041602
880 TZ-11	54	15.8	17.2	11	041626
880 TZ-12	54	17	18.5	12.3	041633
880 TZ-13	54	18.4	18.5	12	041664
880 TZ-14	54	19.5	19.5	15	041688
880 TZ-15	60	20.8	19.5	15	041701
880 TZ-16	60	21.8	18.5	16	041718
880 TZ-17	60	23	18.5	16	041725
880 TZ-18	66	24.4	20	20	041749
880 TZ-19	66	25.5	20	20	041756
880 TZ-20	70	26.6	21	22	041763
880 TZ-21	70	28	22	22	041794
880 TZ-22	70	29.6	21	22	041800

Universal Joint 6-Point Socket



- With hinge
- For working in areas with restricted access
- drive 10 = 3/8"
- For manual operation
- Surface: chrome-plated, polished
- Made in Germany**

HAZET No.	l mm	d ₁ mm	d ₂ mm	t mm	EAN-No. 4000896+
880 G-10	43	13.8	19	6.8	040414
880 G-11	43	15	19	6.8	040438
880 G-12	44	16.6	19	7.3	040445
880 G-13	44	17.8	19	7.3	040452
880 G-14	45	19	19	9.3	040469
880 G-15	45	20.4	19	9.3	040476
880 G-16	46	22	19	9.2	040483
880 G-17	46	22.8	19	9.2	040490
880 G-18	47	24.5	19	10.2	040506
880 G-19	48	25.2	19	11.2	040513

Universal Joint Socket Set (6-Point)



- 10 pieces
- In plastic drawer insert
- Made in Germany**

Contents: 880 G-10 11 12 13 14 15 16 17 18 19

HAZET No.	EAN-No. 4000896+
880 G/10	121090



Hand Tools – Range of 10 3/8" Sockets

TORX® Socket



- drive 10 = 3/8"
- For outside TORX® screws
- With knurling
- For manual operation
- Surface: chrome-plated, polished

Germany **Made in Germany**

HAZET No.	l mm	d1 mm	d2 mm	mm	EAN-No. 4000896+
880-E 5	28	7	17	4.75	039258
880-E 6	28	8	17	5.74	039272
880-E 7	28	9	17	6.22	039296
880-E 8	28	10.5	17	7.52	039319
880-E 10	28	13	17	9.42	039159
880-E 11	28	14	17	10.08	039180
880-E 12	28	14.9	17	11.17	039197
880-E 14	28	16.5	18.5	12.90	039227

TORX® Impact Socket



- For outside TORX® screws
- For impact operation
- drive 10 = 3/8"
- Surface: phosphated

Germany **Made in Germany**

HAZET No.	l mm	d1 mm	d2 mm	mm	EAN-No. 4000896+
880 S-E 10	28	14	19	9.42	041237
880 S-E 12	28	15.9	19	11.17	041251
880 S-E 14	28	17.7	19	12.90	041275

Magnetic Socket Insert

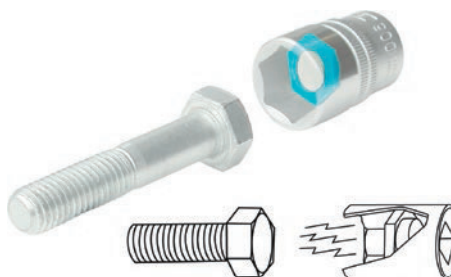

- Holds nuts and screws firmly in the socket
- Inserts made of plastic with integrated magnet
- Powerful retention force
- Universal application in all metric 6-point and 12-point sockets, sizes 10 up to 19 mm
- Easily inserted and removed
- Reusable
- 10 pieces, for metric sockets

HAZET No.	EAN-No. 4000896+
960 MgT	097661

TORX® Socket

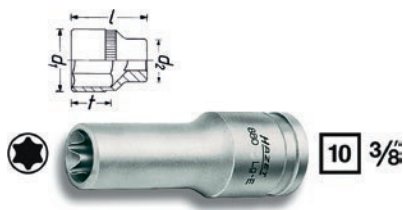

- drive 10 = 3/8"
- For outside TORX® screws
- With knurling
- For manual operation
- Surface: chrome-plated, polished

Germany **Made in Germany**

HAZET No.	l mm	d1 mm	d2 mm	mm	EAN-No. 4000896+
880 Lg-E 8	65	10.5	17	7.52	053070
880 Lg-E 10	65	13	17	9.42	053087
880 Lg-E 12	65	14.9	17	11.17	053100
880 Lg-E 14	65	16.5	18.5	12.90	053117



- With hinge
- For working in areas with restricted access
- drive 10 = 3/8"
- For outside TORX® screws
- For manual operation
- Surface: chrome-plated, polished

Germany **Made in Germany**

HAZET No.	l mm	d1 mm	d2 mm	mm	EAN-No. 4000896+
880 G-E 8	43	19	19	7.52	040599
880 G-E 10	44	19	19	9.42	040537
880 G-E 12	46	19	19	11.17	040551
880 G-E 14	48	19	19	12.90	040575

TORX® Socket Set



4 TORX® Sockets with universal joint

Germany **Made in Germany**

Contents:

880 G-E 8 E 10 E 12 E 14

HAZET No.	EAN-No. 4000896+
880 G-E/4	040520

Spark Plug Socket

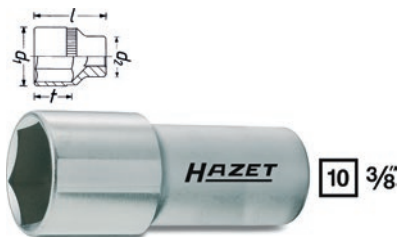

- For spark plug changing
- Long style
- drive 10 = 3/8"
- With permanent magnet
- For manual operation

Germany **Made in Germany**

HAZET No.	S mm	S" mm	l mm	d mm	EAN-No. 4000896+
880 Mg T	20.8	13/16	64	27.4	040872
880 A Mg T	16	5/8	64	21.7	040247



- For spark plug changing on motorcycles, e.g. HONDA, YAMAHA, SUZUKI, KAWASAKI etc.
- With permanent magnet
- drive 10 = 3/8"
- With outside hexagon 17 mm
- Surface: chrome-plated, polished

Germany **Made in Germany**

HAZET No.	S mm	l mm	d1 mm	d2 mm	EAN-No. 4000896+
880 Mg T-18	18	62	23.5	22.8	040889



- For spark plug changing
- With permanent magnet
- drive 10 = 3/8"
- With outside guide collar 23.6 mm for deeply located spark plugs
- Surface: chrome-plated, polished

Germany **Made in Germany**

HAZET No.	S mm	S" mm	l mm	d1 mm	d2 mm	EAN-No. 4000896+
880 A Mg T-1	16	5/8	64	21.9	21	040254



HAZET
www.hazet.de

Good tools
are a matter
of trust!

Spark Plug Socket

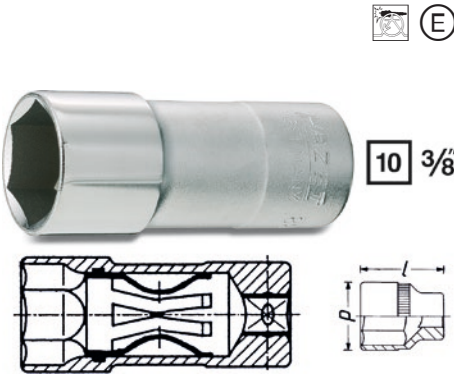

- For spark plug changing
- **With fixing clamp** to hold the spark plug
- The fixing clamp reduces the risk of insulator damage
- □ drive 10 = 3/8"
- For manual operation
- Surface: chrome-plated, polished

Made in Germany

HAZET No.	S mm	S" mm	l mm	d mm	FAN-No. 4000896+
880 KF	20.8	13/16	64	27.4	040674
880 A KF	16	5/8	64	21.6	040131
4766	16	97	21.4	18	049295
4766-1	16	270	21.4	18	048991
4766-2	14	64	18	17.3	087655



Made in Germany

HAZET No.	FAN-No. 4000896+
Fixing clamp for 880 KF, 900 KF, 4767 KF	
880 KF-01	050123
Fixing clamp for 880 A KF, 900 A KF, 4766, 4766-1, 4767 A KF	
880 A KF-01	050130

INFORMATION fixing clamp

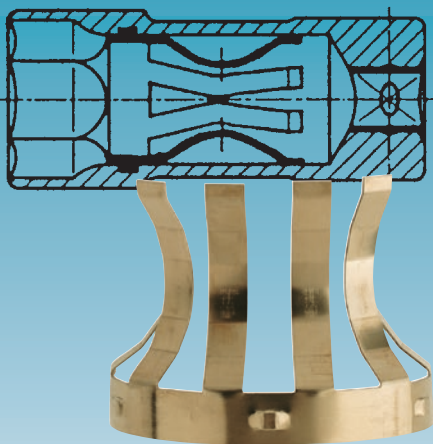

- ✓ Stainless and insensitive to heat
- ✓ Largest possible clearance of insulator
- ✓ 6 spring elements – firm hold of the spark plug
- ✓ Damping of transverse motion

Screwdriver Socket

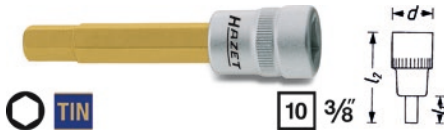

- □ drive 10 = 3/8"
- For **inside hexagon screws**
- With knurling
- For manual operation
- Surface: CVD-TIN coated
- DIN 7422

Made in Germany

± 3-9 - 12: not according to DIN
+ = with offset blade

HAZET No.	S mm	l ₁ mm	l ₂ mm	d mm	FAN-No. 4000896+
8801-3+	3	23.5	50	17	039364
8801-4+	4	28.5	55	17	039371
8801-5+	5	33.5	60	17	039388
8801-6	6	38.5	65	17	039395
8801-7+	7	43.5	70	19	039401
8801-8	8	48.5	75	19	039425
8801-9+	9	52.5	80	19	039432
8801-10	10	57.5	85	19	039340

For brake calliper screws on **MERCEDES-BENZ** ML-Class, type 166, year 2011.
For controlled screw tightening use a torque wrench with □ drive 10 = 3/8", e.g. HAZET 6110-1CT

8801-11	11	60	87.5	19	166299
8801-12	12	62.5	90	19	039357

Screwdriver Socket Set



- 185 x 153 x 52 mm
- With **TIN-coated blades**
 - □ drive 10 = 3/8"
 - For **inside hexagon screws**
 - In SmartCase 165-S (1/9) with **Safety-Insert-System**, 2-component soft foam insert
 - With knurling
 - For manual operation
 - DIN 7422
 - Surface: CVD-TIN coated

Made in Germany

Contents: 8801-4 5 6 7 8 10

HAZET No.	FAN-No. 4000896+
8801/6	186853

Screwdriver Socket

- **American sizes**
 - □ drive 10 = 3/8"
 - For **inside hexagon screws**
 - With knurling
 - For manual operation
 - Surface: CVD-TIN coated
- Made in Germany**
- + = with offset blade

HAZET No.	l ₁ mm	l ₂ mm	d mm	FAN-No. 4000896+
8801 A-1/8 +	23.5	50	17	039487
8801 A-3/32 +	28.5	55	17	039524
8801 A-1/16 +	33.5	60	17	039494
8801 A-7/32 +	38.5	65	17	039531
8801 A-1/4 +	43.5	70	19	039470
8801 A-9/16	48.5	75	19	039517
8801 A-5/8 +	52.5	80	19	039500

Screwdriver Socket



- □ drive 10 = 3/8"
- For **inside hexagon screws**
- With knurling
- Short style
- For manual operation
- Surface: CVD-TIN coated
- DIN 7422

Made in Germany

* = not according to DIN

HAZET No.	S mm	l ₁ mm	l ₂ mm	d mm	FAN-No. 4000896+
8801 K- 3	3	17	43.5	17	053582
8801 K- 4 *	4	17	43.5	17	053599
8801 K- 5	5	17	43.5	17	053605
8801 K- 6	6	17	43.5	17	053612
8801 K- 7	7	17	43.5	19	053629
8801 K- 8	8	17	43.5	19	053636
8801 K- 9 *	9	17	43.5	19	053643
8801 K-10	10	17	43.5	19	053650
2584-8	8	7	24	19	149438
2784-1	7	7	24	19	148530

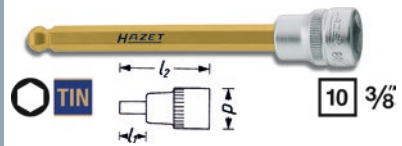

- With **ball head**
 - □ drive 10 = 3/8"
 - For **inside hexagon screws**
 - With knurling
 - For manual operation
 - Surface: CVD-TIN coated
- Made in Germany**

HAZET No.	S mm	l ₁ mm	l ₂ mm	d mm	FAN-No. 4000896+
8801 KK- 5	5	89.5	116	17	039586
8801 KK- 6	6	89.5	116	17	039593
8801 KK- 7	7	89.5	116	19	039609
8801 KK- 8	8	89.5	116	19	039616
8801 KK-10	10	88.5	116	19	039579
2527-5	5	200	227	19	016303

TORX® Screwdriver Socket



- □ drive 10 = 3/8"
 - For **inside TORX® screws**
 - With knurling
 - For manual operation
 - Size T40: For brake calliper screws at the rear axle on **MERCEDES-BENZ** type 211 (E-Class)
 - Surface: CVD-TIN coated
- Made in Germany**

HAZET No.	l ₁ mm	l ₂ mm	d mm	mm	FAN-No. 4000896+
8802-T 15	17	43.5	19	3.27	039647
8802-T 20	17	43.5	19	3.86	039654
8802-T 25	17	43.5	19	4.43	039661
8802-T 27	17	43.5	19	4.99	039678
8802-T 30	17	43.5	19	5.52	039685
8802-T 40	17	43.5	19	6.65	039708
8802-T 45	17	43.5	19	7.82	039722
8802-T 50	17	44.5	19	8.83	039753



Hand Tools – Range of 10 3/8" Sockets

TORX® Screwdriver Socket



TIN

- drive 10 = 3/8"
- For **inside TORX® screws**
- With knurling
- For manual operation
- Surface: CVD-TIN coated

Made in Germany

HAZET No.	l ₁ mm	l ₂ mm	d mm	M	EAN-No. 4000896+
8802 Lg-T 50	42	69.5	19	8.83	159291

Screwdriver Socket

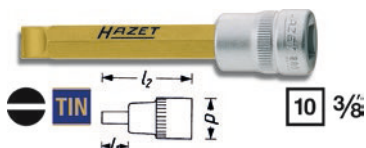

- drive 10 = 3/8"
- For **slotted screws**
- With knurling
- For manual operation
- Surface: CVD-TIN coated
- DIN ISO 2380-1

Made in Germany

HAZET No.	l ₁ mm	l ₂ mm	d mm	M	EAN-No. 4000896+
8803-1 x 5.5	48.5	75	17		039814
8803-1.2 x 8	53.5	80	19		039791
8803-1.6 x 10	62.5	90	19		039807



- drive 10 = 3/8"
- For **Phillips-Recess screws PH**
- With knurling
- For manual operation
- Surface: CVD-TIN coated
- Tip ISO 8764-1

Made in Germany

HAZET No.	l ₁ mm	l ₂ mm	d mm	M	EAN-No. 4000896+
8806-PH 1	23.5	50	17		039845
8806-PH 2	23.5	50	17		039852
8806-PH 3	28.5	55	19		039869
8806-PH 4	32.5	60	19		039876

Screwdriver Socket



TIN

- drive 10 = 3/8"
- For **screws with internal serration XZN**
- With knurling
- For manual operation
- Surface: CVD-TIN coated
- DIN 2325, DIN 2343

Made in Germany

HAZET No.	l ₁ mm	l ₂ mm	d mm	M	EAN-No. 4000896+
8808- 5	13.5	40	19	5	039982
8808- 6	13.5	40	19	6	039999
8808- 8	14.5	41	19	8	040001
8808-10	14.5	42	19	10	039975



- drive 10 = 3/8"
- For **screws with internal serration XZN**
- With knurling
- For manual operation
- Surface: CVD-TIN coated
- DIN 2325, DIN 2343

Made in Germany

HAZET No.	l ₁ mm	l ₂ mm	d mm	M	EAN-No. 4000896+
8808 Lg 70-10	42	69.5	19	10	159307

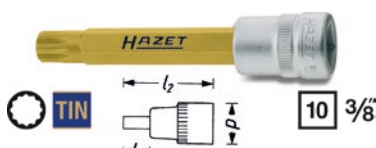

- drive 10 = 3/8"
- For **screws with internal serration XZN**
- With knurling
- For manual operation
- Surface: CVD-TIN coated
- DIN 2325, DIN 2343

Made in Germany

HAZET No.	l ₁ mm	l ₂ mm	d mm	M	EAN-No. 4000896+
8808 Lg- 8	61.5	88	19	8	040025
8808 Lg-10	61.5	89	19	10	040018

VDE Screwdriver Socket

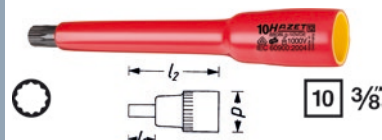

see chapter VDE-/Tools for Electricians page 148

Spin Type Speeder



- drive 10 = 3/8"
- TRInamicULTRA handle
- Haptic elements provide a better grip
- Anti-slipping even with oily hands
- Surface: chrome-plated

Made in Germany

HAZET No.	l mm	EAN-No. 4000896+
8812 U	137	067688

Flexible Handle



- drive 10 = 3/8"
- Surface: chrome-plated
- DIN 3122, ISO 3315

Made in Germany

HAZET No.	l mm	EAN-No. 4000896+
8814	250	042036

Sliding T-Handle



- drive 10 = 3/8"
- Surface: chrome-plated, polished
- DIN 3122, ISO 3315

Made in Germany

HAZET No.	l mm	EAN-No. 4000896+
8815	198	042067

Reversible Ratchet



- drive 10 = 3/8"
- Ratchet wheel 30 teeth
- 2-component handle for optimal handling
- Surface: chrome-plated, polished
- DIN 3122, ISO 3315

Made in Germany

HAZET No.	l mm	EAN-No. 4000896+
8816 P	199	042203

TIN coating

Why choose TIN (Titanium-Nitride) coating?

- ✓ A special coating process for extremely hard TIN coating guarantees high adhesive strength and wear resistance of the coating
- ✓ Particularly suitable for continuous load, e. g. for industrial applications in industry and trade
- ✓ Higher wear protection guarantees a longer lifetime
- ✓ Perfect fitting accuracy through optimum coating thickness
- ✓ Higher torque
- ✓ Optimised corrosion protection

TIN

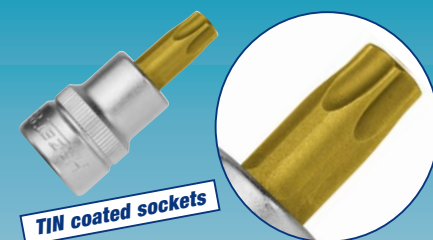

TIN coated sockets

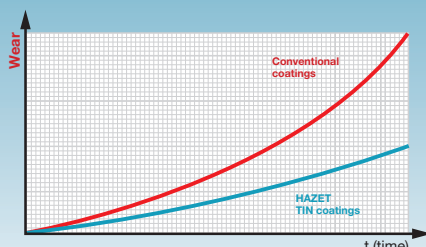

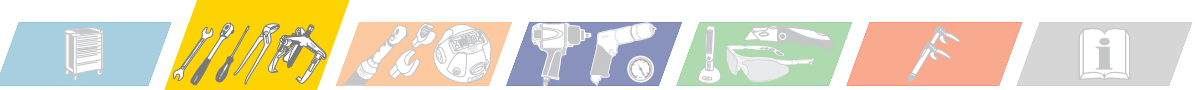

Range of 10 3/8" Sockets

Reversible Ratchet

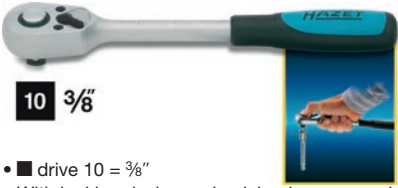

10 3/8"

- drive 10 = 3/8"
- With locking device and quick release press button
- Ratchet wheel 30 teeth
- Safe locking of the sockets
- By pressing the button, attached tools are easily released – with just one hand
- 2-component handle for optimal handling
- Surface: chrome-plated, heads polished

Made in Germany

HAZET No.	l mm	EAN-No. 4000896+
8816 S	199	042241

Fine-Tooth Reversible Ratchet



10 3/8"

- Solid Steel Ratchet
- Lowered Shift Button
- drive 10 = 3/8"
- 72 teeth, actuation angle 5° enable working in areas with restricted access
- Large reversing switch on ratchet top simplifies change-over
- Deep-set reversing switch prevents unintentional change-over
- Cover plate and reversing switch are produced according to the lost-wax casting process, hardened and tempered for excessive use
- Induction hardened teething guarantee high resistance and a long service life
- Sturdy housing with forged ergonomic handle
- Non-slip 2-component handle for optimal handling
- Surface: chrome-plated, polished
- DIN 3122, ISO 3315

Made in Germany

HAZET No.	l mm	EAN-No. 4000896+
8816-1	186	185412

Reversible Ratchet

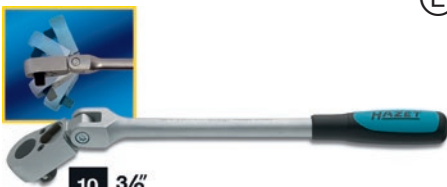

10 3/8"

- Long style
- With hinge for working in areas with restricted access
- 2-component handle for optimal handling
- drive 10 = 3/8"
- Ratchet wheel 30 teeth
- Surface: chrome-plated, polished

Made in Germany

HAZET No.	l mm	EAN-No. 4000896+
8816 G	276	042104

Reversible Ratchet



10 3/8"

- Short style
- With hinge
- drive 10 = 3/8"
- Ratchet wheel 30 teeth
- 2-component handle for optimal handling
- Surface: chrome-plated, polished

Made in Germany

HAZET No.	l mm	EAN-No. 4000896+
8816 GK	218	042142

VDE Reversible Ratchet



10 3/8"

see chapter VDE- / Tools for Electricians page 148

Repair Set

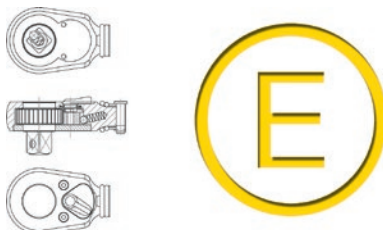

Made in Germany

HAZET No.	EAN-No. 4000896+

Replacement set for shift lever consisting of: shift lever, screws, ball, compression spring, pawl for 8816 G, 8816 GK, 8816 P, 8816 S, 8816 ST 916 K, 2264-1, 6110 CT, 6110-1 CT, 6111-1 CT, 6114-1 CT, 6115-1 CT 6402-1, 6402-1 S, 6408-1

8816 P/6 144617

Replacement set for ratchet wheel 10 = 3/8" consisting of: ratchet wheel 10 = 3/8" ■ screws, ball, compression spring for 8816 G, 8816 GK, 8816 P, 8816 ST, 6110 CT, 6110-1 CT, 6111-1 CT, 6114-1 CT, 6115-1 CT, 6402-1

8816 P/7 N 042234

Plastic handle for: 8814, 8816 P, 8816 F, 8816 G, 8816 GK, 2593 Lg-17

8816 KG-02 042166

Replacement Set for joint connection consisting of: screw and lock washer for 8814, 8816 G, 8816 GK

8816 G-013 042111

Universal Joint



10 3/8"

- drive 10 = 3/8"
- Surface: chrome-plated, heads polished
- DIN 3123, ISO 3316

Made in Germany

HAZET No.	l mm	EAN-No. 4000896+
8820	46.5	042296

Extension



10 3/8"

10 3/8"

- drive 10 = 3/8"
- Surface: chrome-plated, heads polished
- DIN 3123, ISO 3316

Made in Germany

* = Length not according to DIN

HAZET No.	l mm	EAN-No. 4000896+
8821- 1 *	36	042302
8821- 3	74	042357
8821- 5	126	042364
8821- 6 *	150	042371
8821- 8 *	202	042388
8821-10	254	042319
8821-12 *	304	042326
8821-20 *	508	042333
8821-28 *	711	042340

VDE Extension



10 3/8"

10 3/8"

see chapter VDE- / Tools for Electricians page 148

Wobble Extension



10 3/8"

10 3/8"

- drive 10 = 3/8"
- With ball shaped, conical outside square, allows 8° angular movement to every side
- By attaching a socket until its limit stop is reached, the wobble extension may also be used as rigid extension
- Flexible shaft enables operation of screw connections with troublesome borders and working in areas with restricted access
- Surface: chrome-plated, polished

Made in Germany

HAZET No.	l mm	EAN-No. 4000896+
8822- 1	36	042418
8822- 3	74	042432
8822-10	254	042425



Hand Tools – Range of 10 3/8" Sockets

Impact Extension



10 3/8"

10 3/8"

- For impact operation
- □ drive 10 = 3/8"

HAZET No.	l mm	EAN-No. 4000896+
8805 S-6	152	039838

Flexible Extension



10 3/8"

10 3/8"

- □ drive 10 = 3/8"
- Flexible shaft enables operation of screw connections with troublesome borders and fast working even in areas with restricted access

Germany Made in Germany

HAZET No.	l mm	EAN-No. 4000896+
8830	210	042487

Adapter



12.5 1/2"

10 3/8"
8858-1



6.3 1/4"

10 3/8"
8858-2

- □ drive 10 = 3/8"
- Surface: chrome-plated
- DIN 3123, ISO 3316

Germany Made in Germany

HAZET No.	l mm	EAN-No. 4000896+
8858-1	36	042562
8858-2	26	042579

Impact Adapter



12.5 1/2"

10 3/8"
8807 S-1

- For impact operation
- □ drive 10 = 3/8"
- Surface: burnished

Germany Made in Germany

HAZET No.	l mm	EAN-No. 4000896+
8807 S-1	35.5	039951

Impact Adapter



- drive 10 = 3/8" (DIN 3121)
- 8 = 5/16"
- For impact sockets with □ drive 10 = 3/8"
- Surface: burnished

Germany Made in Germany

HAZET No.	l mm	EAN-No. 4000896+
8808 S-1	75	040032

O-Ring and Connecting Pin

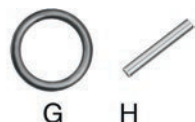

10 3/8"

Germany Made in Germany

HAZET No.	S mm	EAN-No. 4000896+
For sockets □ drive 10 = 3/8" 6–12 mm, E 5–E 14		
880 S-G 612	∅ 13 x 3.5	041381
For sockets □ drive 10 = 3/8" 13–19 mm, extensions, universal joints, adapters		
880 S-G 1317	∅ 16 x 3.5	041374
For sockets □ drive 10 = 3/8" 6–12 mm, E 5–E 14		
880 S-H 612	∅ 2.5 x 14	041404
For sockets □ drive 10 = 3/8" 13–19 mm, extensions, universal joints, adapters		
880 S-H 1317	∅ 2.5 x 16	041398

Safety Spring



HF

- For impact sockets according to DIN 3129

Germany Made in Germany

HAZET No.	S mm	EAN-No. 4000896+
For sockets □ drive 10 = 3/8" 6–12 mm, E 5–E 14		
880 S-HF 612	∅ 16.6	041428
For sockets □ drive 10 = 3/8" 13–19 mm extensions, universal joints, adapters		
880 S-HF 1319	∅ 18.0	041411



Seafarers put their trust
in sea rescuers –
sea rescuers put their trust
in HAZET Quality Tools!

Socket Set (6-Point)



880 Lg/10 H



880 TZ/10 H



880 G/10 H



8801/8 H



8802 T/8 H

880 HL

- drive 10 = 3/8"
- Easy installation: 2 bore holes, e.g. for wall fixation
- Holding clamps adapted to the drive size
- Clear arrangement – sockets are always ready to hand
- Made of metal

HAZET No.	l mm	EAN-No. 4000896+
10 pcs. 6-Point Sockets, long style		
Contents:		
880 Lg-10	11 12 13 14 15 16 17 18 19	
880 Lg/10 H	240	040865
10 pcs. 12-Point Sockets		
Contents:		
880 TZ-10	11 12 13 14 15 16 17 18 19	
880 TZ/10 H	240	041831
10 pcs. 6-Point Sockets with universal joint		
Contents:		
880 G-10	11 12 13 14 15 16 17 18 19	
880 G/10 H	240	040612
8 Screwdriver Sockets for inside hexagon screws		
Contents:		
8801-3	4 5 6 7 8 9 10	
8801/8 H	240	039463
8 Screwdriver Sockets for inside TORX® screws		
Contents:		
8802-T	15 T 20 T 25 T 27 T 30 T 40 T 45 T 50	
8802 T/8 H	240	039784
Empty, with 16 socket clips suitable for sockets of 880 series		
880 HL	430	040650

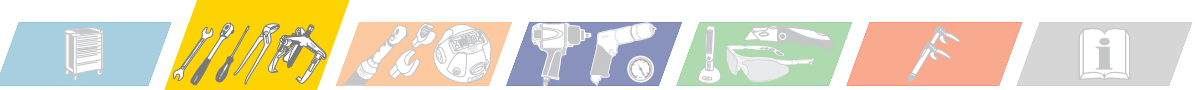

Range of 10 3/8" Sockets

Socket Set (6-Point)

(E) 10 3/8" (R)



355 x 235 x 65 mm

- In SmartCase 165-L (1/3)
- Safety-Insert-System 2-component soft foam insert
- □ drive 10 = 3/8"
- 17 pieces

Made in Germany

Contents:

- 880-10 11 12 13 14 15
16 17 18 19 21 22
8816 P
8820
8821-3 6 10

HAZET No.	EAN-No. 4000896+
880/17	168361

Socket Set (6-Point)

(E) 10 3/8" (R)



344 x 188 x 56 mm

- □ drive 10 = 3/8"
- In plastic box with integrated handle
- With PUR foam insert – all tools are snugly embedded
- 22 pieces

Made in Germany

Contents:

- 880-6 7 8 9 10 11
12 13 14 15 16 17
18 19 20 21 22
8815 8816 P
8820 8821-3 6

HAZET No.	EAN-No. 4000896+
880-2	039036

Socket Set (6-Point)

(E) 6.3 1/4" 10 3/8" (R)



344 x 188 x 56 mm

- Especially suitable for maintenance work on modern cars requiring the use of different screw profiles
- □ drive 6.3 = 1/4"
- □ drive 10 = 3/8"
- – 6-Point Sockets
 - TORX® Sockets
 - Screwdriver Sockets for **inside hexagon** and inside TORX® screws
- In plastic box with integrated handle
- With PUR foam insert – all tools are snugly embedded
- 46 pieces

Made in Germany

Contents:

- 850-6 7 8 9 10 13
850-E 6 E 7 E 8 E 10
863 P 866 U 867-4 869
880-11 12 13 14 15 16
17 18 19 21 22
880-E 11 E 12 E 14
8816 P 8820 8821-6
2204-4 5 6 8
2223-T 10 T 15 T 20 T 25 T 27 T 30 T 40
2224-T 45 T 50 2250-1 3

HAZET No.	EAN-No. 4000896+
882-1	100361

Socket Set (6-Point)

(E) 10 3/8" (R)



279 x 121 x 47 mm

- □ drive 10 = 3/8"
- In plastic box
- With PUR foam insert – all tools are snugly embedded
- 16 pieces

Made in Germany

Contents:

- 880-8 10 11 12 13 14
15 17 19 21 22
8815 8816 P
8820 8821-5 10

HAZET No.	EAN-No. 4000896+
880 N-1	040926

Socket Set (6-Point)

(E) 6.3 1/4" 10 3/8" (R)



344 x 188 x 56 mm

- Especially for motorcycles, motorboats, etc.
- □ drive 6.3 = 1/4"
- □ drive 10 = 3/8"
- In plastic box with integrated handle
- With PUR foam insert – all tools are snugly embedded
- 46 pieces

Made in Germany

Contents:

- 850-4 4,5 5 5,5 6 7
8 9 10 11 12 13
863 P 866 U 867-4 869
880-10 11 12 13 14 15
16 17 18 19 21 22
8816 P 8820 8821-6
2204-3 4 5 6 8
2208-4 6 8 9
2215-PH 1 PH 2 2216-PZ 1 PZ 2 2250-1 2

HAZET No.	EAN-No. 4000896+
882	042289

Socket Set (6-Point)

(E) 10 3/8" (R)



279 x 121 x 47 mm

- Additionally with spark plug sockets
- □ drive 10 = 3/8"
- In plastic box
- With PUR foam insert – all tools are snugly embedded
- 21 pieces

Made in Germany

Contents:

- 880-6 7 8 9 10 11 12 13
14 15 16 17 18 19 21 22
880 A KF 880 KF
8816 P 8820 8821-5

HAZET No.	EAN-No. 4000896+
884 N-1	042531



Hand Tools – Range of 10 3/8" Sockets

Socket Set (6-Point)



344 x 188 x 56 mm

- Additionally with screwdriver sockets
- □ drive 10 = 3/8"
- In plastic box with integrated handle
- With PUR foam insert – all tools are snugly embedded
- **32 pieces**
- **Made in Germany**

Contents:

880-6 7 8 9 10 11 12 13
14 15 16 17 18 19 21 22
8801-4 5 6 8
8803-1 x 5,5 1,2 x 8 1,6 x 10
8806-PH 1 PH 2 PH 3 8815
8816 P 8820 8821-3 5 10

HAZET No.	EAN-No. 4000896+
885 N	042593

Socket Set (12-Point)

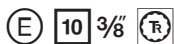

279 x 121 x 47 mm

- □ drive 10 = 3/8"
- In plastic box
- With PUR foam insert – all tools are snugly embedded
- **16 pieces**
- **Made in Germany**

Contents:

880 Z-10 11 12 13 14
15 17 19 21 22
880-8 8815 8816 P
8820 8821-5 10

HAZET No.	EAN-No. 4000896+
880 Z N-1	041992

Socket Set (12-Point)

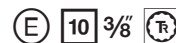

- American sizes
- □ drive 10 = 3/8"
- In plastic box
- With PUR foam insert – all tools are snugly embedded
- **15 pieces**
- **Made in Germany**

Contents:

880 A-1/4 5/16
880 AZ-3/8 7/16 1/2 9/16 5/8
11/16 3/4 13/16 7/8 15/16
8816 P 8820
8821-5

HAZET No.	EAN-No. 4000896+
884 AZ	157402



279 x 121 x 47 mm

Socket Set (6-Point)



- □ drive 10 = 3/8"
- In sheet metal box (HAZET-blue) with plastic insert
- **58 pieces**
- **Made in Germany**

Contents:

880-6 7 8 9 10 11
12 13 14 15 16 17
18 19 20 21 22
880 Lg-9 10 11 12 13 14 15
16 17 18 19 20 21 22
8801-3 4 5 6 7 8 9 10 12
8803-1 x 5,5 1,2 x 8 1,6 x 10
8806-PH 2 PH 3 PH 4
8812 U 8814 8815
8816 P 8820
8821-3 6 8 12
8830 8858-2

HAZET No.	EAN-No. 4000896+
888 N	042623



578 x 235 x 88 mm

Socket Set (12-Point)



- Additionally with screwdriver sockets
- □ drive 10 = 3/8"
- In sheet metal box (HAZET-blue) with plastic insert
- **58 pieces**
- **Made in Germany**

Contents:

880-6 7 8
880 Z-9 10 11 12 13 14 15
16 17 18 19 20 21 22
880 TZ-9 10 11 12 13 14 15
16 17 18 19 20 21 22
8801-3 4 5 6 7 8 9 10 12
8803-1 x 5,5 1,2 x 8 1,6 x 10
8806-PH 2 PH 3 PH 4
8812 8814 8815
8816 P 8820
8821-3 6 8 12 8830
8858-2

HAZET No.	EAN-No. 4000896+
888 ZN	042654



578 x 235 x 88 mm

HAZET – Range of 12⁵/₁₆ Sockets

- ✓ Fine-Tooth Reversible Ratchets
- ✓ Reversible Ratchets with Hinge Joint
- ✓ Telescopic Reversible Ratchet
- ✓ Socket Sets
- ✓ Sockets / Screwdriver Sockets
- ✓ Extensions and many more ...

Reversible Ratchet

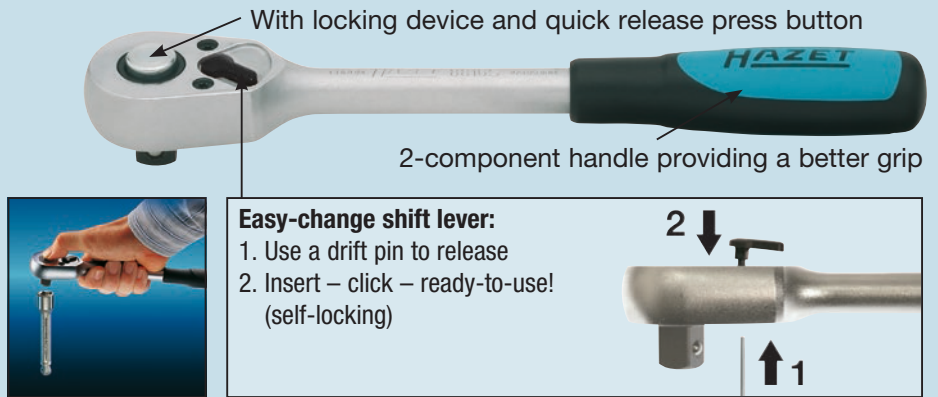

Reversible Ratchet 12⁵/₁₆ short and compact

Short style, only 199 mm, same compact design as a 10³/₁₆ ratchet



Reversible Ratchet 12⁵/₁₆ long and sturdy design



Telescopic Reversible Ratchet 12⁵/₁₆

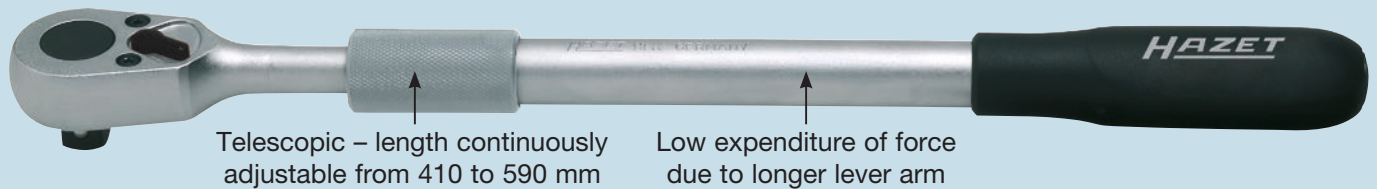

Socket Sets 12⁵/₁₆

Sockets 12⁵/₁₆





Hand Tools – Range of 12.5 1/2" Sockets

6-Point Socket



- drive 12.5 = 1/2"
- With Traction profile
- With knurling
- For manual operation
- Surface: chrome-plated, polished
- DIN 3124, ISO 2725-1

• Made in Germany

* = not according to DIN

HAZET No.	l mm	d ₁ mm	d ₂ mm	t mm	EAN-No. 4000896+
900- 8	38	12	22	7.8	042968
900- 9*	38	13.5	22	8.8	042975
900-10	38	14.9	22	10.8	042715
900-11	38	16.4	22	10.8	042722
900-12	38	17.5	22	11.3	042739
900-13	38	18.8	22	11.3	042746
900-14	38	20.3	22.5	11.8	042753
900-15	38	21.5	23.2	11.8	042760
900-16	38	22.7	23.6	12.2	042777
900-17	38	24.1	22	12.7	042784
900-18	38	25.4	22.4	14.2	042791
900-19	38	26.6	23	14.2	042807
900-20	38	27.8	24	14.2	042821
900-21	38	29	25	14.1	042838
900-22	41.5	30.4	26	17.6	042845
900-23	41.5	31.4	26	17.6	042869
900-24	44	32.6	26	18.2	042876
900-25	44	33.9	26	17.9	042883
900-26	44	35.1	24	17.8	042890
900-27	46	36.2	25	19.7	042906
900-28	47	37.5	26	20.6	042913
900-29*	50	38.7	27	23.4	042920
900-30	50	40.1	28	23.3	042937
900-32	50	42.3	28	23	042944
900-34	52	46	28	23.3	042951

Impact Socket (6-Point)



- Suitable for all types of electric and pneumatic screwdrivers (rotary and impact wrenches)
- For excessive use
- drive 12.5 = 1/2"
- Surface: phosphated
- DIN 3129, ISO 2725-2

• Made in Germany

* = not according to DIN

HAZET No.	l mm	d ₁ mm	d ₂ mm	t mm	EAN-No. 4000896+
900 S- 8	38	14.3	25	6	044511
900 S-10	38	16.8	25	6.9	044085
900 S-12	38	19.5	25	8.5	044122
900 S-13	38	20.8	25	10	044146
900 S-14	38	22.1	25	10	044177
900 S-15	38	23.5	30	11	044191
900 S-16	38	24.8	30	11	044214
900 S-17	38	26.2	30	12	044238
900 S-18	38	27.5	30	12	044283
900 S-19	40	28.8	30	15	044306
900 S-21	40	31.3	30	15	044368
900 S-22	40	32.5	30	15	044382

Impact Socket (6-Point)



HAZET No.	l mm	d ₁ mm	d ₂ mm	t mm	EAN-No. 4000896+
900 S-24	44	35	30	17.5	044429
900 S-25*	44	36.3	30	18.5	044450
900 S-27	45	38.8	30	19.5	044498
900 S-30	50	42	30	23.3	073207
900 S-32*	50	44	30	23	073184

6-Point Socket



- Long style
- drive 12.5 = 1/2"
- With Traction profile
- With knurling
- For manual operation
- Surface: chrome-plated, polished
- DIN 3124, ISO 2725-1

• Made in Germany

HAZET No.	l mm	d ₁ mm	d ₂ mm	t mm	EAN-No. 4000896+
900 Lg-10	85	14.9	22	10	053438
900 Lg-11	85	16.4	22	11.5	053421
900 Lg-12	85	17.5	22	12.3	043873
900 Lg-13	85	18.8	22	13.3	043880
900 Lg-14	85	19.9	22.5	14.2	043897
900 Lg-15	85	21.5	23.2	15.2	043903
900 Lg-16	85	22.7	23.6	16	043910
900 Lg-17	85	24.1	23.6	19	043927
900 Lg-18	85	24.6	23.6	19	043934
900 Lg-19	85	28.5	26	19	043941
900 Lg-21	85	28.6	24.5	19	043965
900 Lg-22	85	30.4	25	22	043972
900 Lg-24	85	32.6	27.5	25	043989
900 Lg-26	85	35.1	29.5	28	043996
900 Lg-27	85	36.3	30	28	044009
900 Lg-30	85	40.1	33	31	044016
900 Lg-32	85	42.5	35	34.2	049660

Impact Socket (6-Point)



- Long style
 - For impact operation
 - drive 12.5 = 1/2"
 - Surface: phosphated
- Made in Germany
- + = reinforced design, with deep hexagon profile for wheel nuts/bolts

HAZET No.	l mm	d ₁ mm	d ₂ mm	t mm	EAN-No. 4000896+
900 S Lg-13	85	20.8	25	13	044764
900 S Lg-15	85	23.5	30	18	104277
900 S Lg-16	85	24.8	30	16	044788
900 S Lg-17	85	26.2	30	18.5	044801

Impact Socket (6-Point)



HAZET No.	l mm	d ₁ mm	d ₂ mm	t mm	EAN-No. 4000896+
900 S Lg-18	85	27.5	30	19	044825
900 S Lg-19	85	28.8	30	19.5	044849
900 S Lg-21 +	85	31.3	30	17.5	044863
900 S Lg-22	85	32.5	30	22	044887
900 S Lg-24	85	35	30	19.5	044917
900 S Lg-27	85	38.8	30	29	044931



- Especially for wheel mounting or dismounting
- Long style
- Extra slim style
- For impact operation
- drive 12.5 = 1/2"
- Surface: phosphated

• Made in Germany

HAZET No.	l mm	d ₁ mm	d ₂ mm	t mm	EAN-No. 4000896+
901 S Lg-15	85	23.5	30	16.5	118298
901 S Lg-17	85	25.7	30	18.5	045723
901 S Lg-19	85	28.2	30	19	045747
901 S Lg-21	85	29.5	30	19.5	118304

Magnetic Holder with Sockets



- For all current wheel bolts, the right sockets are always ready to hand
- Extra slim style
- With magnetic holder – fixation, e.g. on tool trolleys, car lift or tool walls
- drive 12.5 = 1/2"
- 4 pieces
- Surface: phosphated

• Made in Germany

Contents:

901 S Lg-15 17 19 21

HAZET No.	EAN-No. 4000896+
901 S Lg/4	118434
Magnetic Holder, empty	
901 S Lg/4 HL	118380

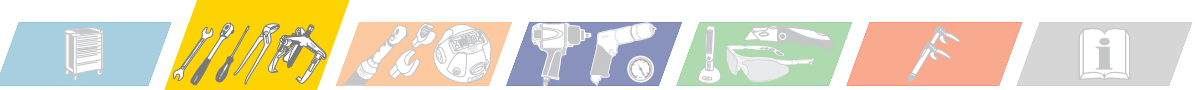

Range of 12.5 1/2 Sockets

Impact Socket (6-Point)

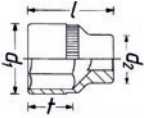

- Especially for wheel mounting or dismounting
- Long style
- Extra slim style
- For impact operation
- **With plastic insert** to protect the surface of the wheel bolts
- □ drive 12.5 = 1/2"
- s 17 = e.g. for wheel bolts on **MERCEDES-BENZ** passenger cars

Made in Germany

HAZET No.	l mm	d ₁ mm	d ₂ mm	t mm	EAN-No. 4000896+
902 S Lg-17	85	25.7	30	18	045778
902 S Lg-19	85	28.2	30	19	045792



- Especially for wheel mounting and dismounting of **light-alloy rims**
- Long style
- For impact operation
- **With plastic insert** to protect the surface of the wheel bolts (903 S Lg-22 without plastic insert)
- Additionally with **outside plastic sleeve** to protect the rims when screwing the wheel bolts
- Colour-coded plastic sleeve facilitates finding the correct socket size
- Replaceable plastic sleeve
- □ drive 12.5 = 1/2"

Made in Germany

HAZET No.	l mm	d ₁ mm	d ₂ mm	t mm	EAN-No. 4000896+
903 S Lg-15: Especially for SMART For Two					
903 S Lg-15	85	26	30	14	072231
903 S Lg-17	85	30	30	14	045822
903 S Lg-19	85	30	30	18	045839

Especially for Japanese cars and **SMART** For Four

903 S Lg-21	85	30	31	17	055135
-------------	----	----	----	----	--------

Especially for wheel mounting and dismounting (wheel nuts) on **OPEL** Insignia. (s 22 mm) replaceable green plastic sleeve

903 S Lg-22	85	30.5	30	22	155453
-------------	----	------	----	----	--------

Impact Socket Set (6-Point)

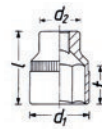

12.5 1/2



Made in Germany

HAZET No.	EAN-No. 4000896+
-----------	------------------

Set of 3 pieces with holding rail: 903 S Lg-17 19 21

Contents:

903 S Lg-17 19 21

903 S Lg/3

060344

Plastic Sleeve

Made in Germany

HAZET No.	EAN-No. 4000896+
-----------	------------------

White, for 903 S Lg-15

903 S Lg-015 081462

Blue, for 903 S Lg-17 045808

903 S Lg-017 045808

Yellow, for 903 S Lg-19 045815

903 S Lg-019 045815

Red, for 903 S Lg-21 055692

903 S Lg-021 055692

Green, for 903 S Lg-22 155255

903 S Lg-022 155255

Impact Socket (6-Point)

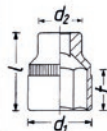

12.5 1/2



- Especially for wheel mounting and dismounting on AMG-rims and/or alloy rims with deeply located wheel bolts
- **Extra long pattern**
- For impact operation
- **With plastic insert** to protect the surface of the wheel bolts
- Additionally with **outside plastic sleeve** to protect the rims when screwing the wheel bolts
- Replaceable plastic sleeve
- □ drive 12.5 = 1/2"

Made in Germany

HAZET No.	l mm	d ₁ mm	d ₂ mm	t mm	EAN-No. 4000896+
904 S Lg-17	130	28.3	30	18.3	100576

Magnetic Socket Insert

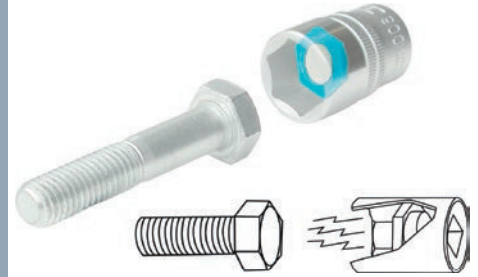

- Holds nuts and screws firmly in the socket
- Inserts made of plastic with integrated magnet
- Powerful retention force
- Universal application in all metric 6-point and 12-point sockets, sizes 10 up to 19 mm
- Easily inserted and removed
- Reusable
- **10 pieces, for metric sockets** s 10 11 12 13 14 15 16 17 18 19 mm

HAZET No.	EAN-No. 4000896+
-----------	------------------

960 MgT

097661

12-Point Socket



12.5 1/2

- □ drive 12.5 = 1/2"
- **With Traction profile**
- With knurling
- For manual operation
- Surface: chrome-plated, polished
- DIN 3124, ISO 2725-1

Made in Germany

* = not according to DIN

HAZET No.	l mm	d ₁ mm	d ₂ mm	t mm	EAN-No. 4000896+
900 Z- 8	38	12	22	7.5	045686
900 Z- 9 *	38	13.5	22	8.5	045693
900 Z-10	38	14.9	22	10.5	045457
900 Z-11	38	16.4	22	10.5	045464
900 Z-12	38	17.5	22	11	045471
900 Z-13	38	18.8	22	11	045488
900 Z-14	38	20.3	22.5	11.5	045495
900 Z-15	38	21.5	23.2	11.5	045501
900 Z-16	38	22.7	23.6	12.5	045518
900 Z-17	38	24.1	22	12.5	045525
900 Z-18	38	25.4	22.4	14	045532
900 Z-19	38	26.6	23	14	045549
900 Z-20	38	27.8	24	14	045556
900 Z-21	38	29	25	14	045563
900 Z-22	41.5	30.4	25	17.5	045570
900 Z-23	41.5	31.4	26	17.5	045587
900 Z-24	44	32.6	26	20	045594
900 Z-25 *	44	33.9	26.5	20	045600
900 Z-26 *	44	35.1	24	20	045617
900 Z-27	46	36.2	25	21	045624
900 Z-28 *	47	37.5	26	22	045631
900 Z-30	50	40.1	28	25	045655
900 Z-32 *	50	42.3	28	24	045662
900 Z-33 *	50	43.6	28	24	045679
900 Z-34	52	46	28	23.3	144792



Hand Tools – Range of 12.5 1/2 Sockets

Impact Socket (12-Point)



- For impact operation
- □ drive 12.5 = 1/2"
- Surface: phosphated

Made in Germany

HAZET No.	l mm	d ₁ mm	d ₂ mm	t mm	EAN-No. 4000896+
900 S Z-12	38	19.5	25	6.8	061785
900 S Z-13	38	20.8	25	6.8	061792
900 S Z-14	38	22.1	25	9.3	061808
900 S Z-15	38	23.5	30	9.3	061815
900 S Z-16	38	24.8	30	9.2	061822
900 S Z-17	38	26.2	30	9.2	061839
900 S Z-18	38	27.5	30	10.7	061846
900 S Z-19	40	28.8	30	11.6	061853
900 S Z-21	40	30	31.3	11.7	075362
900 S Z-22	40	30	32.5	11.7	075379

- s 24 for the operation of the propeller shaft screws on **VW Golf** since 2004, **Touran** since 2004, **Golf Plus** since 2006, **Eos** since 2006, **Scirocco** since 2009, **Tiguan** since 2008, **AUDI A3** since 2004, **TT** since 2007

900 S Z-24	44	35	30	18.6	115556
900 S Z-27	45	38.8	30	29	115822

- s 30 for the axle shaft nut on **VW Golf** 4, **Polo**, **New Beetle**, **AUDI TT** 1.8, **SKODA Octavia**, **Superb**, **Fabia**

900 S Z-30	50	30	42	23	086573
------------	----	----	----	----	--------

- s 32 for the operation of the propeller shaft screws in the wheel hub on **VW Touareg** since 2003 **AUDI A4** since 2001, **A6** since 2005, **A8** since 2003, **Q7** since 2007

900 S Z-32	50	38.2	30	30	115921
900 S Z-34	55	29	30	35	116034

- s 36 for the axle shaft nut on
 - **BMW** 3, 5 and 7 Series, Z3, M3,
 - **VW Polo** since 2001, **SEAT Ibiza** since 2002
 - **VW Golf Plus** 1.8 TDi since 2005, **Polo** 5

900 S Z-36	60	50	30	25	100132
------------	----	----	----	----	--------

12-Point Socket



- American sizes
- □ drive 12.5 = 1/2"
- With Traction profile
- With knurling
- For manual operation
- Surface: chrome-plated, polished

Made in Germany

HAZET No.	l mm	d ₁ mm	d ₂ mm	t mm	EAN-No. 4000896+
900 AZ-3/8	38	14.5	22	10.5	043699
900 AZ-7/16	38	16.4	22	10.5	043729
900 AZ-1/2	38	18.3	22	11	043620
900 AZ-9/16	38	20.5	22.5	11.5	043743
900 AZ-19/32	38	21.5	23.2	11.5	043668
900 AZ-5/8	38	22.7	23.6	12.5	043712
900 AZ-11/16	38	24.6	22	12.5	043637
900 AZ-3/4	38	26.8	23	14	043682
900 AZ-25/32	38	27.8	24	14	043675
900 AZ-13/16	38	28.6	25	14	043644

12-Point Socket

HAZET No.	l mm	d ₁ mm	d ₂ mm	t mm	EAN-No. 4000896+
900 AZ-7/8	41.5	30.4	26	17.5	043736
900 AZ-15/16	44	32.6	26	20	043651
900 AZ-31/32	44	33.4	24.6	20	043705
900 AZ-1	44	34.6	24.8	20	043576
900 AZ-1 1/16	46	36.3	25	21	043583
900 AZ-1 1/8	47	38.2	26.5	22	043606
900 AZ-1 3/16	50	40.1	28	25	043613
900 AZ-1 1/4	50	42.3	28	24	043590



- Long style
- □ drive 12.5 = 1/2"
- With Traction profile
- With knurling
- For manual operation
- Surface: chrome-plated, polished
- DIN 3124, ISO 2725-1

Made in Germany

+ = with rubber ply for spark plugs

HAZET No.	l mm	d ₁ mm	d ₂ mm	t mm	EAN-No. 4000896+
900 TZ-10	85	14.9	22	10	053452
900 TZ-11	85	16.4	22	11.5	053445
900 TZ-12	85	17.5	22	12.3	045242
900 TZ-13	85	18.8	22	13.3	045259
900 TZ-14	85	19.9	22.5	15.2	045266
900 TZ-15	85	21.5	23.2	15.2	045273
900 TZ-16	85	22.7	23.6	16	045280
900 TZ-17	85	24.1	23.6	19	045297
900 TZ-18	85	24.6	23.6	19	045310
900 TZ-19	85	26.8	26	19	045334
900 TZ-20.8-13/16 +	85	28.5	24.5	19	045341
900 TZ-21	85	28.6	24.5	19	045358
900 TZ-22	85	30.4	25	22	045365
900 TZ-24	85	32.6	27.5	25	045389
900 TZ-27	85	36.3	30	28	045419
900 TZ-30	85	40.1	33	31	045426

TORX® Socket



- □ drive 12.5 = 1/2"
- For outside TORX® screws
- With knurling
- For manual operation
- Surface: chrome-plated, polished

Made in Germany

HAZET No.	l mm	d ₁ mm	d ₂ mm	mm	EAN-No. 4000896+
900-E 10	38	13.3	22	9.42	042982
900-E 11	38	14	22	10.08	043002
900-E 12	38	14.9	22	11.17	043019
900-E 14	38	16.7	22	12.90	043033
900-E 16	38	19	22	14.76	043057
900-E 18	38	21	27	16.70	043071
900-E 20	38	23.5	27	18.49	043095
900-E 24	41.2	28.5	27	22.16	043118

TORX® Socket Set



- □ drive 12.5 = 1/2"
- For outside TORX® screws
- With knurling
- For manual operation
- Surface: chrome-plated, polished

5 pieces, in soft foam insert Safety-Insert-System (172 x 50 mm)

Made in Germany

Contents: 900-E 10 E 12 E 14 E 16 E 18

HAZET No.	EAN-No. 4000896+
900-E/5	129331

TORX® Impact Socket



- For outside TORX® screws
- For impact operation
- □ drive 12.5 = 1/2"
- Surface: phosphated

Made in Germany

HAZET No.	l mm	d ₁ mm	d ₂ mm	mm	EAN-No. 4000896+
900 S-E 10	38	14	25	9.42	044542
900 S-E 12	38	15.9	25	11.17	044566
900 S-E 14	38	17.7	25	12.90	044580
900 S-E 16	38	20	25	14.76	044603
900 S-E 18	38	22	30	16.70	044627
900 S-E 20	38	24.5	30	18.49	044641
900 S-E 24	41.2	30	30	22.16	044665

Spark Plug Socket (6-Point)



- For spark plug changing
- Long style
- □ drive 12.5 = 1/2"
- With permanent magnet
- For manual operation
- Surface: chrome-plated, polished

Made in Germany

HAZET No.	s mm	s°	l mm	d ₁ mm	d ₂ mm	t mm	EAN-No. 4000896+
900 Mg T	20.8	13/16	68	27.4	23.5	9	044023
900 A Mg T	16	5/8	71	22.5	22.5	8.5	043491

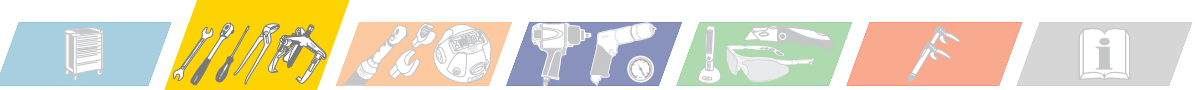

Spark Plug Socket (6-Point)



12.5 1/2"

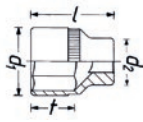
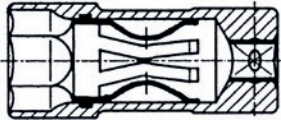

- For spark plug changing
- **With fixing clamp** to hold the spark plug
- The fixing clamp reduces the risk of insulator damage
- □ drive 12.5 = 1/2"
- For manual operation
- Surface: chrome-plated, polished
- **Made in Germany**

HAZET No.	s mm	s" mm	l mm	d ₁ mm	d ₂ mm	t mm	EAN-No. 4000896+
900 KF	20.8	13/16	71	27.4	25	10	043859
900 A KF	16	5/8	71	22.5	22.5	10	043408



Made in Germany

HAZET No.	EAN-No. 4000896+
Fixing clamp for 880 KF, 900 KF, 4767 KF	
880 KF-01	050123
Fixing clamp for 880 A KF, 900 A KF, 4766, 4766-1, 4767 A KF	
880 A KF-01	050130

INFORMATION
fixing clamp

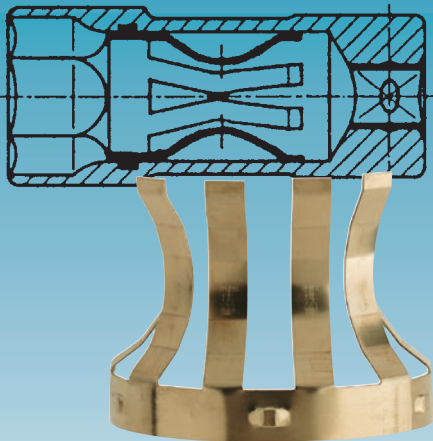

- ✓ Stainless and insensitive to heat
- ✓ Largest possible clearance of insulator
- ✓ 6 spring elements – firm hold of the spark plug
- ✓ Damping of transverse motion

Flexible Handle



12.5 1/2"

- drive 12.5 = 1/2"
- Surface: chrome-plated
- DIN 3122, ISO 3315
- **Made in Germany**

HAZET No.	l mm	EAN-No. 4000896+
914-15	396	046027
914-18	472	046041

Sliding T-Handle



12.5 1/2"

- drive 12.5 = 1/2"
- Surface: chrome-plated, polished
- DIN 3122, ISO 3315
- **Made in Germany**

HAZET No.	l mm	EAN-No. 4000896+
915	298	046072

Fine-Tooth Reversible Ratchet



12.5 1/2"

- Solid Steel Ratchet
- Lowered Shift Button
- drive 12.5 = 1/2"
- 72 teeth, **actuation angle 5°** enable working in areas with restricted access
- Large reversing switch on ratchet top simplifies change-over
- Deep-set reversing switch prevents unintentional change-over
- Cover plate and reversing switch are produced according to the lost-wax casting process, hardened and tempered for excessive use
- Induction hardened teething guarantee high resistance and a long service life
- Sturdy housing with forged ergonomic handle
- Non-slip 2-component handle for optimal handling
- Surface: chrome-plated
- DIN 3122, ISO 3315
- **Made in Germany**

HAZET No.	l mm	EAN-No. 4000896+
916-1	245	162482

Reversible Ratchet



12.5 1/2"

- drive 12.5 = 1/2"
- Ratchet wheel 32 teeth
- 2-component handle for optimal handling
- Surface: chrome-plated, polished
- DIN 3122, ISO 3315
- **Made in Germany**

HAZET No.	l mm	EAN-No. 4000896+
916 SP	275	046317

Reversible Ratchet



12.5 1/2"

- drive 12.5 = 1/2"
- **With locking device and quick-release press-button**
- Ratchet wheel 32 teeth
- Safe locking of the sockets
- By pressing the button, attached tools are easily released – with just one hand
- 2-component handle for optimal handling
- Surface: chrome-plated, heads polished
- **Made in Germany**

HAZET No.	l mm	EAN-No. 4000896+
916 S	275	046287

Reversible Ratchet with Hinge Joint



12.5 1/2"

- Short style
- **With hinge**
- drive 12.5 = 1/2"
- Ratchet wheel 32 teeth
- 2-component handle for optimal handling
- Surface: chrome-plated, polished
- **Made in Germany**

HAZET No.	l mm	EAN-No. 4000896+
916 GK	270	046201

Telescopic Reversible Ratchet



12.5 1/2"

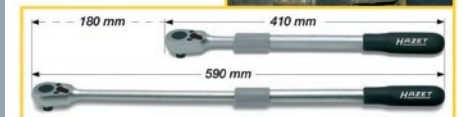

- Especially suitable for commercial vehicles, agricultural machinery and industrial installations
- **Continuously adjustable from 410 to 590 mm**
- Long lever arm reducing the expenditure of force
- **Max. torque 600 Nm**
- Easy fixation with knurled ring
- drive 12.5 = 1/2"
- Ratchet wheel 32 teeth
- Surface: chrome-plated, heads polished
- **Made in Germany**

HAZET No.	l ₁ mm	l ₂ mm	EAN-No. 4000896+
916 Lg	410	590	116591



Hand Tools – Range of 12.5 1/2" Sockets

Reversible Ratchet



Only 199 mm short, in compact design of a 103/6 ratchet

- Adjusted to the more and more confined spaces
- drive 12.5 = 1/2"
- Ratchet wheel 30 teeth
- 2-component handle for optimal handling
- Max. torque 300 Nm
- Surface: chrome-plated, polished

MADE IN GERMANY

HAZET No.	l mm	EAN-No. 4000896+
916 K	199	155736



Especially suitable for commercial vehicles, agricultural machinery and industrial installations

- Hardened and tempered special steel!
- Shank diameter: 15 mm
- Long lever arm reducing the expenditure of force
- Non-slip 2-component handle for optimal handling
- drive 12.5 mm = 1/2"
- Ratchet wheel 32 teeth
- Surface: chrome-plated
- DIN 3122, ISO 3315

MADE IN GERMANY

HAZET No.	l mm	EAN-No. 4000896+
916 L	389	165803

Repair Set

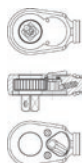

MADE IN GERMANY

HAZET No.	EAN-No. 4000896+
916 S/7	046300

Replacement set for ratchet wheel 12.5 = 1/2" ■ consisting of: shift lever, 2 screws, ball, compression spring, ratchet wheel with quick-release press-button and pawl for 916 S as well as for refitting 916 SP and 916 GK

916 S/7 046300

Replacement set for shift lever 12.5 = 1/2" ■ consisting of: shift lever, 2 screws, ball, compression spring and pawl for 916 S, 916 SP, 916 GK, 916 Lg

916 SP/6 144624

Replacement set for ratchet wheel 12.5 = 1/2" ■ consisting of: shift lever, screws, ball, compression spring, ratchet wheel and pawl for 916 SP, 916 GK, 916 Lg

916 SP/7-1 046348

Replacement set for ratchet wheel 12.5 = 1/2" ■ consisting of: shift lever, screws, ball, compression spring, ratchet wheel and pawl for 916 K

916 K/7 155743

Extension



- drive 12.5 = 1/2"
- 917-1: Length not according to DIN
- Surface: chrome-plated, heads polished
- DIN 3123, ISO 3316

MADE IN GERMANY

HAZET No.	l mm	EAN-No. 4000896+
917-1	45	046362
917-3	76	046379
917-5	123	046386



- drive 12.5 = 1/2"
- 918-23: Length not according to DIN
- Surface: chrome-plated, heads polished
- DIN 3123, ISO 3316

MADE IN GERMANY

HAZET No.	l mm	EAN-No. 4000896+
918-10	248	046416
918-23	575	046423

Adapter Extension



- For operating deeply located screws, e.g. on gearboxes
- drive 12.5 = 1/2"
- drive 10 = 3/8"
- Surface: chrome-plated

MADE IN GERMANY

HAZET No.	l mm	EAN-No. 4000896+
958-28	700	046706

Wobble Extension

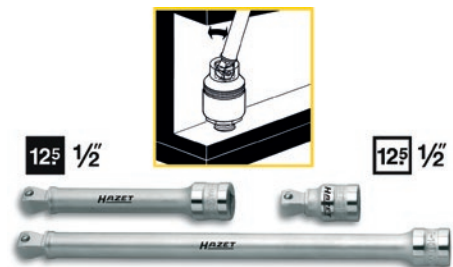

- drive 12.5 = 1/2"
- With ball shaped, conical outside square drive allows 12.5° angular movement to every side
- By attaching a socket until its limit stop is reached, the wobble extension may also be used as rigid extension
- Flexible shaft enables operation of screw connections with troublesome borders and working in areas with restricted access
- Surface: chrome-plated, polished

MADE IN GERMANY

HAZET No.	l mm	EAN-No. 4000896+
919-1	46	046447
919-5	123	046461
919-10	248	046454

Wobble Extension Set

MADE IN GERMANY

HAZET No.	EAN-No. 4000896+
919-1 5 10	046478

Impact Extension



- For impact operation
- drive 12.5 = 1/2"
- Surface: phosphated

MADE IN GERMANY

HAZET No.	l mm	EAN-No. 4000896+
9005 S-5	130	043163

Universal Joint



- drive 12.5 = 1/2"
- Surface: chrome-plated, polished
- DIN 3123, ISO 3316

MADE IN GERMANY

HAZET No.	l mm	EAN-No. 4000896+
920	70	046515

Impact Ball Joint



- For impact operation
- drive 12.5 = 1/2"
- Surface: burnished

MADE IN GERMANY

HAZET No.	l mm	EAN-No. 4000896+
9006 S	69	043170

Adapter



- drive 12.5 = 1/2"
- Surface: chrome-plated
- DIN 3123, ISO 3316

MADE IN GERMANY

HAZET No.	l mm	EAN-No. 4000896+
958-1	50	046676
958-2	36	046683

Adapter Set



In HAZET plastic drawer insert, 6 pieces, 1 adapter each

Made in Germany

Contents:

- 858-1 8858-1 2
- 958-1 2 1058-2

HAZET No.	EAN-No. 4000896+
958/6	073900
Plastic drawer insert, empty for 958/6	
958/6 PL	073191

Impact Adapter



- For impact operation
- □ drive 12.5 = 1/2"
- Surface: burnished

Made in Germany

HAZET No.	l mm	EAN-No. 4000896+
drive 10 = 3/8"		
9007 S	37	072545
drive 20 = 3/4"		
9007 S-1	49	043217

Screwdriver Socket Set



320 x 128 x 58 mm

- For inside hexagon screws
- □ drive 12.5 = 1/2"
- In sheet metal box (HAZET-blue) with plastic insert
- 12 pieces

Made in Germany

Contents:

- 985-5 6 8 10 12 14 17 19
- 915 916 SP 917-5 918-10

HAZET No.	EAN-No. 4000896+
985	046768

Screwdriver Socket



- For slotted screws
- □ drive 12.5 = 1/2"
- Surface: chrome-plated

Made in Germany

HAZET No.	l ₁ mm	l ₂ mm	d mm	EAN-No. 4000896+
980-2 x 13	21	38	22	046737
980-3 x 19	20	38	23.7	046744



- For inside hexagon screws
- □ drive 12.5 = 1/2"
- With knurling
- DIN 7422

Made in Germany

* = not according to DIN

HAZET No.	s mm	l ₁ mm	l ₂ mm	d mm	EAN-No. 4000896+
985- 4 *	4	5	38	22	046829
985- 5 *	5	5	38	23	046836
985- 6	6	6	38	23	046843
985- 8	8	8	38	23	046850
985-10	10	10	40	25	046775
985-12	12	12	40	25	046782
985-14	14	14	40	25	046799
985-17 *	17	17	42	28	046805
985-19 *	19	19	42	28	046812

Screwdriver Socket



With TIN-coated blades

- For inside hexagon screws
- □ drive 12.5 = 1/2"
- With knurling
- 986-22 not according to DIN
- Surface: CVD-TIN coated
- DIN 7422

Made in Germany

* = not according to DIN

HAZET No.	s mm	l ₁ mm	l ₂ mm	d mm	EAN-No. 4000896+
986-4 *	4	22	60	23	046928
986-5 *	5	22	60	23	046935
986-6	6	22	60	23	046942
986-7	7	22	60	23	046959
986-8	8	22	60	23	046973

For brake calliper screws on **MERCEDES-BENZ** M-Class (type 164) and R-Class (type 251), **BMW** X5 year 2009 (E70), X6 year 2008 (E71)

986- 9	9	22	60	23	146734
986-10	10	22	60	23	046874
986-12	12	22	60	24.6	046881
986-14	14	22	60	24.6	046898
986-17 *	17	20	60	28.5	046904
986-19 *	19	20	60	31.5	046911
986-22	22	20.5	60	28	082865
2584	6	32	70	23	017041



185 x 153 x 52 mm

In SmartCase 165-S (1/9) Safety-Insert-System, 2-component soft foam insert

6 pieces, 1 adapter each

Made in Germany

Contents:

- 858-1 8858-1 2
- 958-1 2 1058-2

HAZET No.	EAN-No. 4000896+
958 N/6	168316

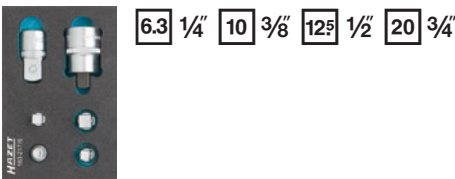

6.3 1/4" 10 3/8" 12.5 1/2" 20 3/4"

Made in Germany

HAZET No.	EAN-No. 4000896+
-----------	------------------

6 pieces in soft foam insert Safety-Insert-System (for SmartCase S 1/3) 1 adapter each

Contents:

- 858-1 8858-1 2
- 958-1 2 1058-2

163-217/6	168231
-----------	--------





Hand Tools – Range of 12.5 1/2" Sockets

Screwdriver Socket

- American sizes
- For inside hexagon screws
- □ drive 12.5 = 1/2"
- With knurling
- Surface: CVD-TIN coated

MADE IN GERMANY

HAZET No.	l ₁ mm	l ₂ mm	d mm	EAN-No. 4000896+
986 A-5/32	14	52	23	047048
986 A-3/16	14	52	23	047017
986 A-7/32	14	52	23	047062
986 A-1/4	14	52	23	047000
986 A-5/16	14	52	23	047031
986 A-3/8	14	52	23	047024
986 A-7/16	14	52	23	047055
986 A-1/2	14	52	23	046997

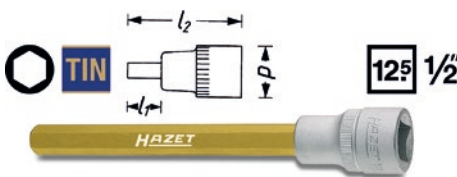

- Long style
- For inside hexagon screws
- □ drive 12.5 = 1/2"
- With knurling
- 986 Lg-5 6 7 9 with offset blade
- Surface: CVD-TIN coated
- DIN 7422

MADE IN GERMANY

HAZET No.	S mm	l ₁ mm	l ₂ mm	d mm	EAN-No. 4000896+
986 Lg- 5*	5	142	180	23	047109
986 Lg- 6	6	99	137	23	047116
986 Lg- 7	7	62	100	23	047123
986 Lg- 8	8	42	80	24.6	047130

Suitable e.g. for brake calliper screws on twin piston brakes VW T5 since 2010

For controlled screw tightening use a torque wrench, e.g. HAZET 6121-1 CT

986 Lg- 9	9	70	108	24.6	156481
986 Lg-10	10	103	141	24.6	047086

- For installing and removing the fuel filter on VW/AUDI diesel engines with engine code AJM since 5/1999 (Passat B5, Golf 4, Bora, AUDI A3 and A4), as well as SEAT and ŠKODA diesel engines
- Also suitable for fuel filter draining

986 Lg-13	13	60	100	24.6	089222
-----------	----	----	-----	------	--------

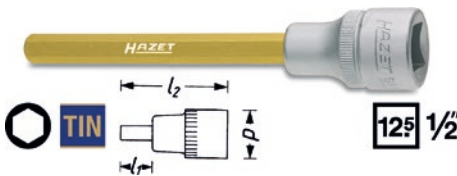

- Extra long style
- For inside hexagon screws
- □ drive 12.5 = 1/2"
- With knurling
- Surface: CVD-TIN coated
- DIN 7422

MADE IN GERMANY

HAZET No.	S mm	l ₁ mm	l ₂ mm	d mm	EAN-No. 4000896+
986 S Lg-6	6	112	160	23	047147
986 S Lg-8	8	81	119	23	047154
2584-1	6	210	248	23	017058

Screwdriver Socket

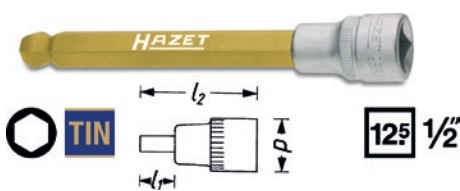

- With ball head especially for working in areas with restricted access (e.g. engine compartment)

- For inside hexagon screws

- □ drive 12.5 = 1/2"

- With knurling

- Surface: CVD-TIN coated

MADE IN GERMANY

HAZET No.	S mm	l ₁ mm	l ₂ mm	d mm	EAN-No. 4000896+
986 KK- 5	5	102	140	23	052103
986 KK- 6	6	102	140	23	050666
986 KK- 7	7	102	140	23	052110
986 KK- 8	8	102	140	23	052127
986 KK-10	10	102	140	23	052134
986 KK-12	12	102	140	24.6	052141

2527-8	8	200	238	23	016310
--------	---	-----	-----	----	--------

Screwdriver Socket Set



185 x 153 x 52 mm

With TIN-coated blades

- Screwdriver sockets for inside hexagon screws

- □ drive 12.5 = 1/2"

- In SmartCase 165-S (1/9) with Safety-Insert-System, 2-component soft foam insert

- 9 pieces

- Surface: CVD-TIN coated

MADE IN GERMANY

Contents:	986-5	6	7	8	10	12	14	17	19
-----------	-------	---	---	---	----	----	----	----	----

HAZET No.	EAN-No. 4000896+
986/9	051564

Screwdriver Socket Set



355 x 235 x 65 mm

In SmartCase 165-L (1/3) Safety-Insert-System, 2-component soft foam insert

- For inside hexagon screws

- □ drive 12.5 = 1/2"

- With knurling

- 13 pieces

MADE IN GERMANY

Contents:	986-5	6	7	8	10	12	14	17	19
	986 KK-6	7	8	10					

HAZET No.	EAN-No. 4000896+
986/13	168330



185 x 153 x 52 mm

In SmartCase 165-S (1/9) Safety-Insert-System, 2-component soft foam insert

- For inside hexagon screws

- □ drive 12.5 = 1/2"

- With knurling

- 5 pieces

MADE IN GERMANY

Contents:	986-5	6	7	8	10
-----------	-------	---	---	---	----

HAZET No.	EAN-No. 4000896+
986/5	168293

TIN coating

Why choose TIN (Titanium-Nitride) coating?

- ✓ A special coating process for extremely hard TIN coating guarantees high adhesive strength and wear resistance of the coating
- ✓ Particularly suitable for continuous load, e.g. for industrial applications in industry and trade
- ✓ Higher wear protection guarantees a longer lifetime
- ✓ Perfect fitting accuracy through optimum coating thickness
- ✓ Higher torque
- ✓ Optimised corrosion protection

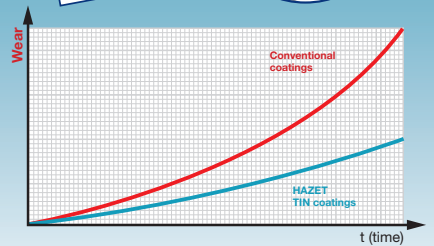
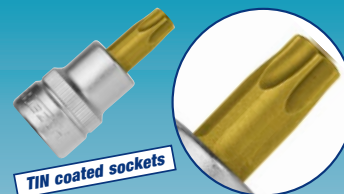

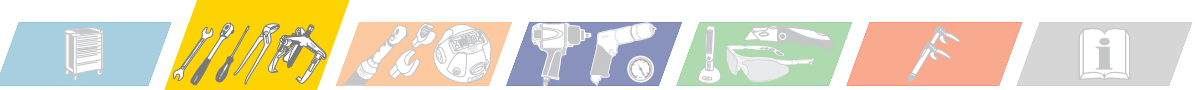

Range of 125 1/2 Sockets

Screwdriver Socket Set



125 1/2

Made in Germany

HAZET No.	EAN-No. 4000896+
-----------	------------------

5 pieces in soft foam insert Safety-Insert-System (for SmartCase S 1/9)
Contents:
986-5 6 7 8 10

163-215/5	168217
-----------	--------

125 1/2

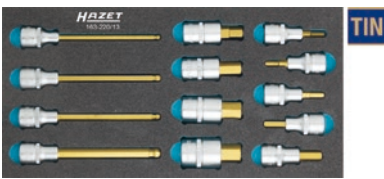

Made in Germany

HAZET No.	EAN-No. 4000896+
-----------	------------------

13 pieces in soft foam insert Safety-Insert-System (for SmartCase L 1/3)
Contents:
986-5 6 7 8 10 12 14 17 19
986 KK-6 7 8 10

163-220/13	168286
------------	--------

Screwdriver Socket



- Short style
- For screws with internal serration XZN
- □ drive 12.5 = 1/2"
- With knurling
- Surface: CVD-TIN coated

Made in Germany

HAZET No.	l ₁ mm	l ₂ mm	d mm	M	EAN-No. 4000896+
990-5	14	52	23	5	047307
990-6	14	52	23	6	047314
990-8	15	53	23	8	047321
990-10	15	53	23	10	047253
990-12	17	55	23	12	047277
990-14	20	58	24.6	14	047284
990-16	22	60	24.6	16	047291

For installing and removing the wheel bearing/hub unit at the rear axle on **AUDI** A 3 since 2004, **VW** Touran since 2004, Golf 5, **ŠKODA** Octavia since 2008

990-18	45	85	26	18	108916
--------	----	----	----	----	--------

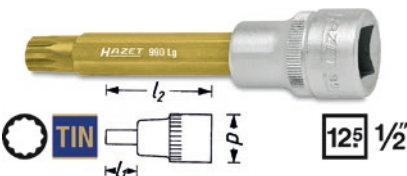

- Long style
- For screws with internal serration XZN
- □ drive 12.5 = 1/2"
- With knurling

Screwdriver Socket

990 Lg-8: E.g. for cardan shafts on **VW**, **AUDI**
990 Lg-9: For cylinder head bolts on **TOYOTA** Corolla 1.4 I and Yaris 1.0 I
990 Lg-14: For cylinder head bolts on VM diesel engines, e.g. **CHRYSLER**

- Surface: CVD-TIN coated

Made in Germany

HAZET No.	l ₁ mm	l ₂ mm	d mm	M	EAN-No. 4000896+
990 Lg- 6	62	100	23	6	056248
990 Lg- 8	62	100	23	8	047352
990 Lg- 9	62	100	23	9	103140
990 Lg-10	62	100	23	10	047338
990 Lg-12	62	100	23	12	047345
990 Lg-14	62	100	23	14	065240
2751	100	140	23	10	017508

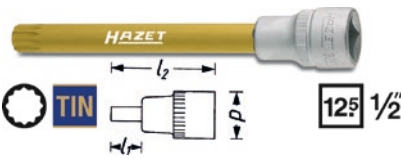

- Extra long style
- For screws with internal serration XZN
- □ drive 12.5 = 1/2"
- With knurling
- For cylinder head bolts on engines of different car types, e.g. **VW**, **AUDI**, **OPEL**, **TOYOTA**
- Surface: CVD-TIN coated

Made in Germany

HAZET No.	l ₁ mm	l ₂ mm	d mm	M	EAN-No. 4000896+
990 S Lg-10	82	120	23	10	047369
990 S Lg-12	102	140	23	12	047376

Screwdriver Socket Set

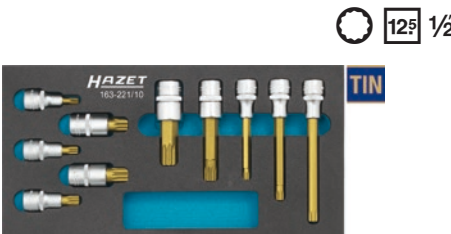

Made in Germany

HAZET No.	EAN-No. 4000896+
-----------	------------------

10 pieces in soft foam insert Safety-Insert-System (for SmartCase L 1/3)
Contents:

- 990-8 10 12 14 16 18
- 990 Lg-8 14
- 990 S Lg-10 12

163-221/10	168262
------------	--------

XZN Screwdriver Socket Set



Made in Germany

HAZET No.	EAN-No. 4000896+
-----------	------------------

7 pieces in soft foam insert Safety-Insert-System (for SmartCase S 1/9)
Contents:

- 990-6 8 10 12 14 16 18

163-243/7	178032
-----------	--------

Screwdriver Socket Set



125 1/2

Made in Germany

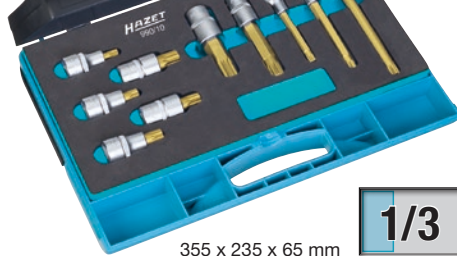

355 x 235 x 65 mm

1/3

In SmartCase 165-L (1/3)
Safety-Insert-System, 2-component soft foam insert

- For screws with internal serration XZN
- □ drive 12.5 = 1/2"
- With knurling
- 10 pieces

Made in Germany

Contents:
990-8 10 12 14 16 18
990 Lg-8 14
990 S Lg-10 12

HAZET No.	EAN-No. 4000896+
990/10	168347

Impact Screwdriver Socket Set



- Esp. for commercial vehicles e.g. for the operation of the engine and chassis screw connections (also suitable for passenger cars)
- For impact operation

For screws with internal serration XZN

- Choice of □ drive 12.5 = 1/2" or ● 24 mm
- Surface: phosphated
- 3 screwdriver sockets, length 43 mm
- 3 screwdriver sockets, length 75 mm
- 1 Adapter □ drive 20 = 3/4" - □ 24 mm
- Includes each two o-rings and connecting pins
- Set of 11 pieces in Safety-Insert-System

Made in Germany

Contents:
990 S-14 16 18
990 S-14 Lg 16 Lg 18 Lg
1003 S-1
1000 S-G 1736 (2x) 1000 S-H 1736 (2x)

HAZET No.	EAN-No. 4000896+
990 S/11	162406



Hand Tools – Range of 12.5 1/2" Sockets

Impact Screwdriver Socket



- **Esp. for commercial vehicles** e.g. for the operation of the engine and chassis screw connections (also suitable for passenger cars)
 - For impact operation
 - For screws with internal serration XZN
 - Choice of □ drive 12.5 = 1/2" or ● 24 mm
 - Surface: phosphated
- Made in Germany**

HAZET No.	l ₁ mm	l ₂ mm	M	EAN-No. 4000896+
990 S-14	4	43	14	160846
990 S-16	5	43	16	160853
990 S-18	6	43	18	160860

For the lower brake carrier screw at the rear axle on **VW Passat** year 2009



- **Esp. for commercial vehicles** e.g. for the operation of the engine and chassis screw connections (also suitable for passenger cars)
 - For impact operation
 - For screws with internal serration XZN
 - Choice of □ drive 12.5 = 1/2" or ● 24 mm
 - Surface: phosphated
- Made in Germany**

HAZET No.	l ₁ mm	l ₂ mm	M	EAN-No. 4000896+
990 S-14 Lg	39.7	75	14	161003
990 S-16 Lg	40.6	75	16	161010
990 S-18 Lg	41.1	75	18	161027

Screwdriver Socket



- For spline socket screws RIBE CV
 - □ drive 12.5 = 1/2"
 - With knurling
 - Surface: CVD-TIN coated
- Made in Germany**

HAZET No.	l ₁ mm	l ₂ mm	d mm	M	EAN-No. 4000896+
991-5	25	63	23	5	047444
991-6	25	63	23	6	047451

For car body and engine work on **FIAT** e.g. for valve and spark plug covers

991-7	25	63	23	7	132799
991-8	25	63	23	8	047468

FIAT engines 1.2 8V/16 V

991-9	25	63	23	9	132812
991-10	25	63	23	10	047406

For cylinder head bolts on **FIAT 2.0** engines

991-12	25	63	23	12	047413
--------	----	----	----	----	--------

For cylinder head bolts on **ALFA**, e.g. 1.6 16V engines

991-13	25	63	24.6	13	132829
991-14	25	63	24.6	14	047420
991-16	25	63	24.6	16	047437

RIBE-CV Screwdriver Socket Set

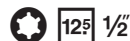

Made in Germany

HAZET No.	EAN-No. 4000896+
991-6 7 8 9 10 12 14	178056

7 pieces in soft foam insert Safety-Insert-System (for SmartCase S 1/9)
Contents:

TORX® Screwdriver Socket



With TIN-coated blades

- Short style
 - For inside TORX® screws
 - □ drive 12.5 = 1/2"
 - With knurling
 - Surface: CVD-TIN coated
- Made in Germany**

HAZET No.	l ₁ mm	l ₂ mm	d mm	mm	EAN-No. 4000896+
992-T 20	17	55	23	3.86	047475
992-T 25	17	55	23	4.43	047482
992-T 27	17	55	23	4.99	047499
992-T 30	17	55	23	5.52	047505
992-T 40	17	55	23	6.65	047512
992-T 45	17	55	23	7.82	047529
992-T 50	17	55	23	8.83	047543
992-T 55	18	56	24.6	11.22	047574
992-T 60	18	56	24.6	13.25	047598

TORX® Screwdriver Socket Set



With TIN-coated blades

- For inside TORX® screws
 - □ drive 12.5 = 1/2"
 - In SmartCase 165-S (1/9) with Safety-Insert-System, 2-component soft foam insert
 - 9 pieces
 - Surface: CVD-TIN coated
- Made in Germany**

HAZET No.	EAN-No. 4000896+
992-T 20 T 25 T 27 T 30 T 40 T 45 T 50 T 55 T 60	051540

Contents:

TORX® Screwdriver Socket



- Short style
 - With front hole
 - For tamper resistant TORX® screws (inside TORX® screws with pin)
 - □ drive 12.5 = 1/2"
 - With knurling
 - Surface: CVD-TIN coated
- Made in Germany**

HAZET No.	l ₁ mm	l ₂ mm	d mm	mm	EAN-No. 4000896+
992-T 30 H	17	55	23	5.52	050857
992-T 40 H	17	55	23	6.65	050864
992-T 45 H	17	55	23	7.82	050871
992-T 50 H	17	55	23	8.83	050888
992-T 55 H	18	56	23	11.22	050895
992-T 60 H	18	56	23	13.25	062973

TORX® Screwdriver Socket Set



In SmartCase 165-S (1/9) Safety-Insert-System, 2-component soft foam insert

- For tamper resistant TORX® screws (inside TORX® screws with pin)
 - □ drive 12.5 = 1/2"
 - With knurling
 - 5 pieces
- Made in Germany**

HAZET No.	EAN-No. 4000896+
992 H/5	168309

Contents:

TORX® Screwdriver Socket Set



Made in Germany

HAZET No.	EAN-No. 4000896+
992-T 30 H T 40 H T 45 H T 50 H T 55 H	168224

Contents:

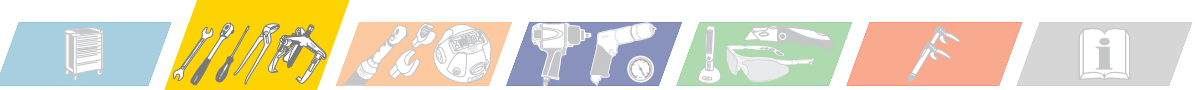

TORX® Screwdriver Socket

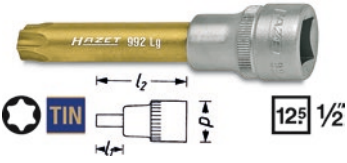

- Long style
- For inside TORX® screws
- □ drive 12.5 = 1/2"
- With knurling
- T 70: For cylinder head bolts on FORD 1.8 I diesel (Turbo), Fiesta, Escort, Sierra
- Surface: CVD-TIN coated
- **Made in Germany**

HAZET No.	l ₁ mm	l ₂ mm	d mm	mm	EAN-No. 4000896+
992 Lg-T 50	62	100	23	8.83	103133
992 Lg-T 55	57	96	23.3	11.22	057337
992 Lg-T 60	45	83	23	13.25	100590
992 Lg-T 70	67	105	24.6	15.54	047611

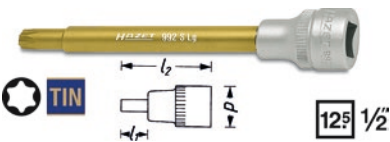

- Extra long style
- For inside TORX® screws
- □ drive 12.5 = 1/2"
- With knurling
- Surface: CVD-TIN coated
- **Made in Germany**

HAZET No.	l ₁ mm	l ₂ mm	d mm	mm	EAN-No. 4000896+
992 S Lg-T 40	100	138	23	6.65	103539

For the intake manifold on FORD Scorpio 2.4 2.8 and 2.9 l injection engine.
VW Passat gearbox type 02 A, 1.6 1.8 and 2.0 l

HAZET No.	l ₁ mm	l ₂ mm	d mm	mm	EAN-No. 4000896+
992 S Lg-T 45	100	138	23	7.82	047635
992 S Lg-T 50	100	138	23	8.83	103454

For cylinder head bolts on various FORD engines, e.g. Mondeo 16 V

HAZET No.	l ₁ mm	l ₂ mm	d mm	mm	EAN-No. 4000896+
992 S Lg-T 55	102	138	23	11.22	047642



- For inside TORX® screws
- □ drive 12.5 = 1/2"
- For manual operation
- For cylinder head installation and removal on BMW engines N20 (4-cylinder petrol engines): F20, F21:125i, F30:320i, 320iX, 328i, 328iX, F31:328i, F10, F11:520i, 528i N20, 528iX, F18:520Li E84:X1 20i, X1 20iX, X1 28iX, F25:X3 20iX, X3 28iX E89:Z4 20i, Z4 28i
- **Made in Germany**

HAZET No.	d mm	mm	l ₁ mm	l ₂ mm	EAN-No. 4000896+
992 S Lg-T 55-130	23	11.22	130	168	174997

TORX® Impact Screwdriver Socket



- For inside TORX® screws
- For impact operation
- □ drive 12.5 = 1/2"

TORX® Impact Screwdriver Socket

- Surface: phosphated
- **Made in Germany**

HAZET No.	l ₁ mm	l ₂ mm	d mm	mm	EAN-No. 4000896+
995 S-T 30	21.4	40	25.1	5.52	047666
995 S-T 40	21.1	40	25.1	6.65	047680
995 S-T 45	21.1	40	25.1	7.82	057597
995 S-T 50	22.4	40	25.1	8.83	047703
995 S-T 55	22.4	40	25.1	11.22	047727
995 S-T 60	22.1	40	25.1	13.25	047741

O-Ring and Connecting Pin



- **Made in Germany**

HAZET No.	S mm	EAN-No. 4000896+
For sockets □ drive 12.5 = 1/2"		
8-14 mm, 13 mm long style, E 10-E 16, T 30-T 60		
900 S-G 1014	∅ 19 x 4	044689
For sockets □ drive 12.5 = 1/2"		
15-27 mm, 16-27 mm long style, E 18-E 24, extensions, universal joints, adapters		
900 S-G 1527	∅ 24 x 4	044696
For sockets □ drive 12.5 = 1/2"		
8-14 mm, 13 mm long style, E 10-E 16, T 30-T 60		
900 S-H 1014	∅ 3 x 20	044702
For sockets □ drive 12.5 = 1/2"		
15-27 mm, 16-27 mm long style, E 18-E 24, extensions, universal joints, adapters		
900 S-H 1527	∅ 3 x 26	044719

Safety Spring



- For impact sockets according to DIN 3129
- **Made in Germany**

HAZET No.	S mm	EAN-No. 4000896+
For sockets □ drive 12.5 = 1/2"		
8-14 mm, E 10-E 16		
900 S-HF 814	∅ 21	044733
For sockets □ drive 12.5 = 1/2"		
15-27 mm, E 18-24, extensions, universal joints, adapters		
900 S-HF 1530	∅ 25	044726

Socket Rail



- □ drive 12.5 = 1/2"
 - Easy installation: 2 bore holes, e.g. for wall fixation
 - Holding clamps adapted to the drive size
 - Clear arrangement - sockets are always ready to hand
 - Made of metal
- Empty, with 16 socket clips suitable for sockets of 900 series

HAZET No.	l mm	EAN-No. 4000896+
900 HL	430	043842

Socket Set (6-Point)

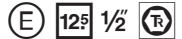

410 x 216 x 65 mm

- □ drive 12.5 = 1/2"
- In plastic box with integrated handle
- With PUR foam insert - all tools are snugly embedded
- 25 pieces
- **Made in Germany**

Contents:

900-10	11	12	13	14
	15	16	17	18
	19	20	21	22
	23	24	26	27
	28	30	32	
915	916 SP			
917-5	918-10			
920				

HAZET No.	EAN-No. 4000896+
900	042685

Socket Set (6-Point)

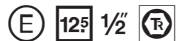

410 x 216 x 65 mm

- □ drive 12.5 = 1/2"
- In plastic box with integrated handle
- With PUR foam insert - all tools are snugly embedded
- 17 pieces
- **Made in Germany**

Contents:

900-10	11	12	13	14	15	17
	19	22	24	27	30	32
915	916 SP	917-5	918-10			

HAZET No.	EAN-No. 4000896+
906	045891



Hand Tools – Range of 12.5 1/2" Sockets

Ingenious Tools

Socket Set (6-Point)



410 x 216 x 56 mm

- Additionally with screwdriver sockets, bits and adapter
- □ drive 12.5 = 1/2"
- In plastic box with integrated handle
- With PUR foam insert – all tools are snugly embedded
- **44 pieces**

Made in Germany

Contents:

900-10 11 12 13 14 15 17 19 20
 21 22 23 24 26 27 28 30 32
 915 916 SP 917-5 918-10 920
 986-5 6 7 8 10 12 14
 2217-PH 1 PH 2 PH 3 PH 4
 2218-PZ 1 PZ 2 PZ 3 PZ 4
 2224-T 27 T 30 T 40 T 45 T 50
 2250-5

HAZET No.	EAN-No. 4000896+
954 N	046621

Socket Set (12-Point)



410 x 216 x 65 mm

- □ drive 12.5 = 1/2"
- In plastic box with integrated handle
- With PUR foam insert – all tools are snugly embedded
- **25 pieces**

Made in Germany

Contents:

900 Z-10 11 12 13 14 15 16 17 18 19
 20 21 22 23 24 26 27 28 30 32
 915 916 SP 917-5 918-10 920

HAZET No.	EAN-No. 4000896+
900 Z	045440

Socket Set (6-Point)

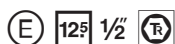

435 x 215 x 62 mm

- □ drive 12.5 = 1/2"
- In sheet metal box (HAZET-blue) with plastic insert
- **30 pieces**

Made in Germany

Contents:

900-8 9 10 11 12 13 14 15 16 17 18 19
 20 21 22 23 24 25 26 27 28 30 32
 914-15 915 916 SP
 917-5 918-10 920
 980-2 x 13

HAZET No.	EAN-No. 4000896+
905	045846

Socket Set (12-Point)

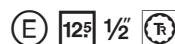

435 x 215 x 62 mm

- □ drive 12.5 = 1/2"
- In sheet metal box (HAZET-blue) with plastic insert
- **30 pieces**

Made in Germany

Contents:

900 Z-8 9 10 11 12 13 14 15 16 17 18 19
 20 21 22 23 24 25 26 27 28 30 32
 914-15 915 916 SP
 917-5 918-10 920
 980-2 x 13

HAZET No.	EAN-No. 4000896+
905 Z	045877

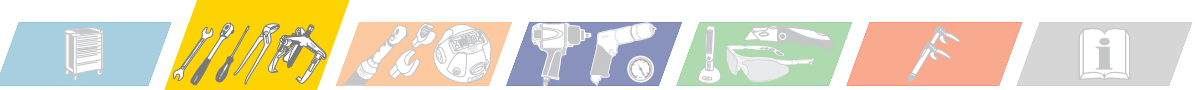

Range of 12.5 1/2" Sockets

Socket Set (12-Point)

(E) 12.5 1/2" (R)



410 x 216 x 65 mm

- American sizes
- □ drive 12.5 = 1/2"
- In plastic box with integrated handle
- With PUR foam insert – all tools are snugly embedded
- 23 pieces
- **Made in Germany**

Contents:
 900 AZ- 3/8 7/16 1/2 9/16 5/8 11/16 3/4
 29/32 13/16 7/8 15/16 31/32 1 1 1/16 1 1/8
 1 3/16 1 1/4
 915 916 SP 917-5 918-10 920

HAZET No.	EAN-No. 4000896+
900 A Z	043569

Impact Socket Set (6-Point)

(E) 12.5 1/2" (R)



435 x 215 x 59 mm

- For impact operation
- □ drive 12.5 = 1/2"
- In sheet metal box (HAZET-blue)
- With plastic insert
- 23 pieces
- **Made in Germany**

Contents:
 900 S-13 14 16 17 18 19 21 22 24 27
 900 S Lg-13 16 17 18 19 21 22 24 27
 900 S-HF 1530 HF 814
 9005 S-5 9006 S

HAZET No.	EAN-No. 4000896+
900 S	057153

Socket Set (12-Point)

(E) 12.5 1/2" (R)



410 x 216 x 65 mm

- American and metric sizes
- □ drive 12.5 = 1/2"
- In plastic box with integrated handle
- With PUR foam insert – all tools are snugly embedded
- 36 pieces
- **Made in Germany**

Contents:
 900 Z-10 11 12 13 14 15 16 17
 18 19 21 22 24 27 30 32
 900 AZ- 3/8 7/16 1/2 9/16 5/8 11/16 3/4 13/16
 7/8 15/16 1 1 1/16 1 1/8 1 3/16 1 1/4
 915 916 SP 917-5 918-10 920

HAZET No.	EAN-No. 4000896+
907 AM Z	045969

Socket Set (6-Point)

(E) 12.5 1/2" (R)



355 x 235 x 65 mm

- In SmartCase 165-L (1/3)
- Safety-Insert-System, 2-component soft foam insert
- □ drive 12.5 = 1/2"
- 18 pieces
- **Made in Germany**

Contents:
 900-10 11 12 13 14 15 16
 17 18 19 21 22 24 27
 916 SP
 917-5
 918-10
 920

HAZET No.	EAN-No. 4000896+
932/18	168378

1/3



HAZET – Range of 20 3/4" Sockets

- ✓ **Socket Sets**
- ✓ **Reversible Ratchet Heads**
- ✓ **Sockets**
- ✓ **Screwdriver Sockets**
- ✓ **Universal Joints**
- ✓ **Extensions, Adapters and many more ...**



Range of 20 3/4" Sockets

6-Point Socket



- □ drive 20 = 3/4"
- With knurling
- For manual operation
- With locking pin
- Surface: chrome-plated, polished
- DIN 3124, ISO 2725-1

Made in Germany
* = not according to DIN

HAZET No.	l mm	d ₁ mm	d ₂ mm	t mm	EAN-No. 4000896+
1000-19 *	52	28	33.2	14.5	000623
1000-21	52	31	33.2	14	000647
1000-22	52	32	33.2	14	000654
1000-24	52	34	36	16.5	000661
1000-27	54	38	35	19.3	000678
1000-30	55	42	36	21.5	000692
1000-32	58	44.5	36	24	000708
1000-33	59	46	36	24.5	000715
1000-34	60	47.5	36	25.5	000722
1000-36	61.5	49.5	38	26.5	000746
1000-38 *	65	52.5	39	29	000760
1000-41	68.5	55.5	39	32	000784
1000-42 *	70	57.5	41	32	000791
1000-46	73	62	44	34	000807
1000-50	67	67	45	32.5	000814
1000-55 *	67	73.5	45	35	000821
1000-60 *	67	80	45	32.3	000838

Impact Socket (6-Point)

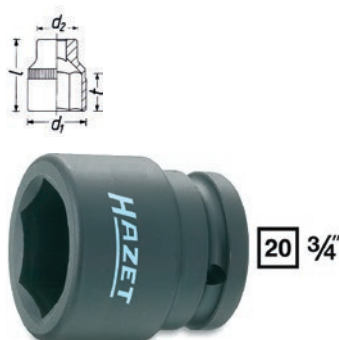

- Suitable for all types of electric and pneumatic screwdrivers (rotary and impact wrenches)
- For excessive use
- □ drive 20 = 3/4"
- Surface: phosphated
- DIN 3124, ISO 2725-1

Made in Germany
* = not according to DIN

HAZET No.	l mm	d ₁ mm	d ₂ mm	t mm	EAN-No. 4000896+
1000 S-19 *	48	32	44	13	001231
1000 S-22	50	36.5	44	16	001248
1000 S-24	50	39.5	44	17	001255
1000 S-27	51	43.5	44	19	001262
1000 S-28 *	54	45	44	19	001279
1000 S-30	54	47.4	44	-	001293
1000 S-32	54	49.9	44	21	001309
1000 S-33 *	54	51.5	44	21	001316
1000 S-34	54	52.4	44	22	001323
1000 S-36	57	54.9	44	23	001330

Impact Socket (6-Point)



- Long style
- For impact operation
- □ drive 20 = 3/4"
- Surface: chrome-plated, polished
- DIN 3124, ISO 2725-1

Made in Germany

HAZET No.	l mm	d ₁ mm	d ₂ mm	t mm	EAN-No. 4000896+
1000 S Lg-24	100	39.5	44	17	001392
1000 S Lg-27	100	43.5	44	19	001408
1000 S Lg-30	100	47.5	44	21	001422
1000 S Lg-32	100	50	44	21	001439
1000 S Lg-33	100	51.5	44	21	001446
1000 S Lg-36	100	55	44	23	001460



Your commercial vehicle specialist!

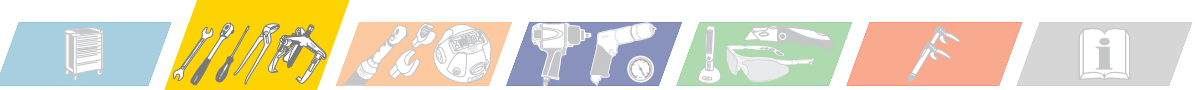

Impact Socket (6-Point)



- Especially long 6-Point Socket e.g. for **deeply located wheel nuts and bolts** on commercial vehicles
- For impact operation
- □ drive 20 = 3/4"
- Surface: chrome-plated, polished
- DIN 3124, ISO 2725-1
- **Made in Germany**

HAZET No.	l mm	d ₁ mm	d ₂ mm	t mm	EAN-No. 4000896+
1004 S-32	400	48	44	32	055784

12-Point Socket



- □ drive 20 = 3/4"
- With knurling
- For manual operation
- With locking pin
- Surface: chrome-plated, polished
- DIN 3124, ISO 2725-1
- **Made in Germany**

HAZET No.	l mm	d ₁ mm	d ₂ mm	t mm	EAN-No. 4000896+
1000 Z-22	52	32	33.2	13.5	001507
1000 Z-24	52	34	36	16	001521
1000 Z-27	54	38	35	18.8	001552
1000 Z-30	55	42	36	21	001583
1000 Z-32	58	44.5	36	23.4	001590
1000 Z-34	60	47.5	36	24.8	001613
1000 Z-35*	61.5	48.5	35.5	25.8	001620
1000 Z-36	61.5	49.5	36	25.7	001637
1000 Z-38*	65	52.5	38	28.3	001644
1000 Z-41	68.5	55.5	39	31.2	001651
1000 Z-46	73	62	44	34	001675
1000 Z-50	67	67	45	37.1	001699
1000 Z-55	67	73.5	45	40.8	001712

12-Point Socket



- **American sizes**
- □ drive 20 = 3/4"
- With knurling
- For manual operation
- With locking pin
- Surface: chrome-plated, polished
- **Made in Germany**

HAZET No.	l mm	d ₁ mm	d ₂ mm	t mm	EAN-No. 4000896+
1000 AZ-7/8	52	32	33.2	13.5	001170
1000 AZ-15/16	52	34	36	16.9	001132
1000 AZ-1	52	36.5	33.2	16.9	000999
1000 AZ-1 1/16	54	38	35	18.8	001002
1000 AZ-1 1/8	55	40	36	20.8	001033
1000 AZ-1 3/16	55	42	36	21	001064
1000 AZ-1 1/4	58	44.5	36	23.4	001026
1000 AZ-1 5/16	59	46	36	23.9	001095
1000 AZ-1 3/8	61.5	48.5	36	25.8	001088
1000 AZ-1 7/16	63	50	36	27.2	001118
1000 AZ-1 1/2	65	52.5	38	28.6	001019
1000 AZ-1 5/8	68.5	55.5	39	31.2	001101
1000 AZ-1 3/4	72	60	41	33.6	001071
1000 AZ-1 7/8	73	62	44	34	001057
1000 AZ-1 7/8	73	64	45	35	001125
1000 AZ-2	78	68	45	38.7	001149

TORX® Cylinder Head Tool



For the operation of cylinder head bolts

- **TORX®** Impact Socket
- **Suitable for impact wrenches**
- □ drive 20 = 3/4"
- Reinforced design
- Surface: phosphated
- **Made in Germany**

HAZET No.	l mm	t mm	EAN-No. 4000896+
On MAN commercial vehicles F 2000, F 90, F 8 and MAN buses with D 25 and D 28 engines			
2850-E 20	110	18.49	079681
On MAN commercial vehicles with Common Rail engine (D20)			
2850-E 24	110	22.16	146758

Screwdriver Socket

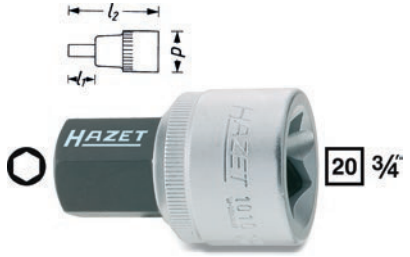

- □ drive 20 = 3/4"
- For **inside hexagon screws**
- With knurling
- For manual operation
- With locking pin
- Surface: chrome-plated, tips burnished
- DIN 7422
- **Made in Germany**

HAZET No.	s mm	l ₁ mm	l ₂ mm	d mm	EAN-No. 4000896+
1010-14	14	16.7	54.5	36	001842
1010-17	17	19.7	54.5	36	001859
1010-19	19	21.7	56.5	36	001866
1010-22	22	24.7	56.5	36	001873

Brake Calliper Screwdriver Socket



For the operation of the brake calliper screws (Knorr-Bremse) on **MERCEDES-BENZ** commercial vehicles e.g. Actros

- Enables controlled screwing with the torque value required by the manufacturer (Follow manufacturer's instructions) e.g. with torque wrench HAZET 6144-1CT
- **Made in Germany**

HAZET No.	s mm	l ₁ mm	l ₂ mm	EAN-No. 4000896+
2784-14	14	60	110	155583

TORX® Screwdriver Socket



- For inside TORX® screws, e.g. on commercial vehicles and agricultural machinery
- Application, e.g. at the front axle: screws of the steering tie lever on commercial vehicles **MAN**
- 1012-T 80 for M series
- 1012-T 100 for F series
- Surface: CVD-TIN coated
- **Made in Germany**

HAZET No.	l ₁ mm	l ₂ mm	t mm	EAN-No. 4000896+
1012-T 60	28	80	13.25	087488
1012-T 70	28	80	15.54	087495
1012-T 80	28	80	17.59	087501
1012-T 90	28	80	19.95	087518
1012-T 100	28	80	22.15	087525

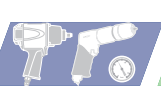

Hand Tools – Range of 20 3/4" Sockets

Handle Bar



- With ball and pin locking device
- For sliding head HAZET 1015-1 or ratchet head HAZET 1016
- Surface: chrome-plated
- DIN 3122

Made in Germany

HAZET No.	l mm	EAN-No. 4000896+
1014	500	001897

Sliding Head



- drive 20 = 3/4"
- With locking ball
- For handle bar HAZET 1014 or 1014 P
- Surface: chrome-plated, polished
- DIN 3122

Made in Germany

HAZET No.	l mm	EAN-No. 4000896+
1015-1	60	001910

Handle Bar with Sliding Head



- drive 20 = 3/4"
- 2 pieces
- handle bar HAZET 1014 and sliding head HAZET 1015-1
- Surface: chrome-plated, polished
- DIN 3122

Made in Germany

HAZET No.	l mm	EAN-No. 4000896+
1015/2	500	001927

Contents:
1014 1015-1

Reversible Ratchet Head



- drive 20 = 3/4"
- with ball and pin locking device
- Shank with locking pin
- Ratchet wheel 32 teeth
- Surface: chrome-plated

Made in Germany

HAZET No.	l mm	EAN-No. 4000896+
1016	165	001941

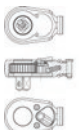

Replacement set for shift lever
consisting of: shift lever, screws, ball, compression spring
for 1016, 1016/2,
6132-1 CT, 6143 CT, 6143-1 CT, 6143-01 CT,
6144 CT, 6144-1 CT, 6144-01 CT, 6145 CT,
6145-1 CT, 6145-01 CT, 6146-1 CT

1016/6	-	001972
--------	---	--------

Reversible Ratchet Head



HAZET No.	l mm	EAN-No. 4000896+
1016/8 N	-	001989

Reversible Ratchet with Handle Bar



- drive 20 = 3/4"
- Surface: chrome-plated, polished
- DIN 3122, ISO 3315

Made in Germany

Contents:
1014 1016

HAZET No.	l mm	EAN-No. 4000896+
1016/2	620	001965

Extension



- drive 20 = 3/4"
- with ball and pin locking device
- with locking pin
- 1017-8 = DIN 3123, ISO 3316
- Surface: chrome-plated, polished

Made in Germany

HAZET No.	l mm	EAN-No. 4000896+
1017-3	75	001996
1017-8	200	002016



- drive 20 = 3/4"
- DIN 3123, ISO 3316

Made in Germany

HAZET No.	l mm	EAN-No. 4000896+
1018	400	002030

Impact Extension



- For impact operation
- drive 20 = 3/4"
- Surface: burnished

Made in Germany

HAZET No.	l mm	EAN-No. 4000896+
1005 S- 7	175	001774
1005 S-13	330	001767

Universal Joint

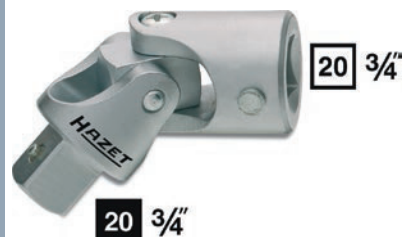

- drive 20 = 3/4"
- with ball and pin locking device
- with locking pin
- Surface: chrome-plated
- DIN 3123, ISO 3316

Made in Germany

HAZET No.	l mm	EAN-No. 4000896+
1021	105	002054

Impact Ball Joint



- For impact operation
- drive 20 = 3/4"
- Surface: burnished

Made in Germany

HAZET No.	l mm	EAN-No. 4000896+
1006 S	99	001781

Adapter

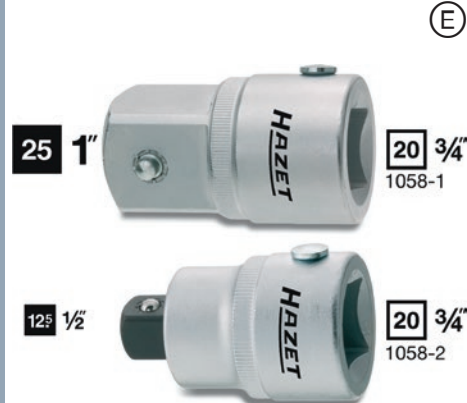

- drive 20 = 3/4"
- with locking pin
- Surface: chrome-plated
- DIN 3123, ISO 3316

Made in Germany

HAZET No.	l mm	EAN-No. 4000896+
1058-1	60.6	002061
1058-2	52.3	002078
Insert square for 1058-2		
1058-02	-	111763

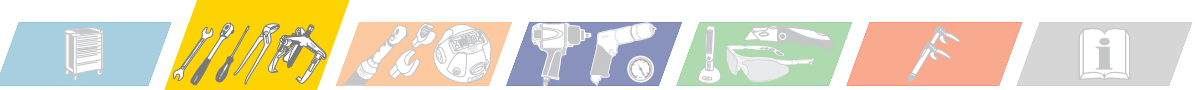

Impact Adapter



- For impact operation
- □ drive 20 = 3/4"
- Surface: phosphated
- **Made in Germany**

HAZET No.	l mm	EAN-No. 4000896+
■ drive 12.5 = 1/2"		
1007 S-1	56	001804
■ drive 25 = 1"		
1007 S-2	65	001828

O-Ring and Connecting Pin



For all □ 20 = 3/4" connections
Made in Germany

HAZET No.	S mm	EAN-No. 4000896+
1000 S-G 1736	∅ 36x5	001354
1000 S-H 1736	∅ 4x36	001361

Socket Set (6-Point)

(E) □ 20 3/4"



578 x 235 x 88 mm

- □ drive 20 = 3/4"
- In sheet metal box (HAZET-blue) with plastic insert
- 15 pieces
- **Made in Germany**

Contents:

1000-22	24	27	30	32	
	36	38	41	46	50
1014	1015-1	1016			
1017-8	1018				

HAZET No.	EAN-No. 4000896+
1000	000616

Socket Set (6-Point)

(E) □ 20 3/4"



578 x 235 x 88 mm

- □ drive 20 = 3/4"
- In sheet metal box (HAZET-blue) with plastic insert
- 18 pieces
- **Made in Germany**

Contents:

1000-22	24	27	30	32	36	
	38	41	46	50	55	60
1014	1015-1	1016				
1017-8	1018	1021				

HAZET No.	EAN-No. 4000896+
1002	001736

Socket Set (12-Point)

(E) □ 20 3/4"



578 x 235 x 88 mm

- □ drive 20 = 3/4"
- In sheet metal box (HAZET-blue) with plastic insert
- 15 pieces
- **Made in Germany**

Contents:

1000 Z-22	24	27	30	32	
	36	38	41	46	50
1014	1015-1	1016			
1017-8	1018				

HAZET No.	EAN-No. 4000896+
1000 Z	001477

Socket Set (12-Point)

(E) □ 20 3/4"



578 x 235 x 88 mm

- □ drive 20 = 3/4"
- In sheet metal box (HAZET-blue) with plastic insert
- 18 pieces
- **Made in Germany**

Contents:

1000 Z-22	24	27	30	32	
	36	38	41	46	50
1000-55	60				
1014	1015-1	1016			
1017-8	1018	1021			

HAZET No.	EAN-No. 4000896+
1002 Z	001743

Socket Set (12-Point)

(E) □ 20 3/4"



578 x 235 x 88 mm

- **American sizes**
- □ drive 20 = 3/4"
- In sheet metal box (HAZET-blue) with plastic insert
- 21 pieces
- **Made in Germany**

Contents:

1000 AZ-7/8	15/16	1	1 1/16	1 1/8		
	1 3/16	1 1/4	1 5/16	1 3/8	1 7/16	
	1 1/2	1 5/8	1 3/4	1 13/16	1 7/8	2
1014	1015-1	1016				
1017-8	1018					

HAZET No.	EAN-No. 4000896+
1000 AZ	000982



HAZET – Range of 25 1" Sockets

- ✓ **Socket Sets**
- ✓ **Reversible Ratchet Heads**
- ✓ **Sockets**
- ✓ **Universal Joints**
- ✓ **Extensions, Adapters and many more ...**



12-Point Socket



- □ drive 25 = 1"
- With knurling
- For manual operation
- With locking pin
- Surface: chrome-plated, polished
- DIN 3124, ISO 2725-1

Made in Germany

* = not according to DIN

HAZET No.	l mm	d ₁ mm	d ₂ mm	t mm	EAN-No. 4000896+
1100 Z-32 *	60	48	46	22	002511
1100 Z-36 *	67	52	48	28.5	002528
1100 Z-41	68	57	48	29.5	002535
1100 Z-46	72	62	48	32	002542
1100 Z-50	74	68	48	35	002559
1100 Z-55	78	74	48	36.5	002566
1100 Z-60	83	80	48	40.5	002573
1100 Z-65	86	88	60	43.5	002580
1100 Z-70	89	96	60	46.5	002603
1100 Z-75	92	102	60	49.5	002610
1100 Z-80	94	108.5	60	52.5	002627

Impact Socket (6-Point)



- Suitable for all types of electric and pneumatic screwdrivers (rotary and impact wrenches)
- For excessive use
- □ drive 25 = 1"

Impact Socket (6-Point)

- Surface: phosphated
- DIN 3124, ISO 2725-1

Made in Germany

* = not according to DIN

HAZET No.	l mm	d ₁ mm	d ₂ mm	t mm	EAN-No. 4000896+
1100 S-24	58	41.5	54	17	002207
1100 S-27	60	45	54	19	002214
1100 S-30	62	49	54	21	002221
1100 S-32	63	51.5	54	21	002238
1100 S-33 *	63	52.5	54	21	002252
1100 S-34	63	53.5	54	22	002269
1100 S-36	67	56.5	54	23	002276
1100 S-41	70	63	54	26	002290
1100 S-46	76	69.5	54	28	002320
1100 S-50	82	74.5	54	30	002344
1100 S-55	87	81	54	32	002351
1100 S-60	91	87	54	34	002375

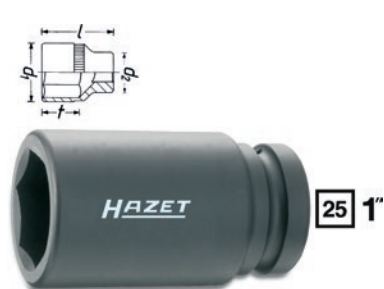

- Long style
- For impact operation
- □ drive 25 = 1"
- Surface: phosphated
- DIN 3124, ISO 2725-1

HAZET No.	l mm	d ₁ mm	d ₂ mm	t mm	EAN-No. 4000896+
1100 S Lg-24	110	41.5	54	17	002405
1100 S Lg-27	110	45	54	19	002412
1100 S Lg-30	110	49	54	21	002429
1100 S Lg-32	110	51.5	54	21	002436
1100 S Lg-33	110	52.5	54	21	002443
1100 S Lg-36	110	56.5	54	23	002467
1100 S Lg-38	110	59	54	24	002474
1100 S Lg-41	110	63	54	26	002481
1100 S Lg-46	110	69.5	54	28	002498

Impact Socket (6-Point)

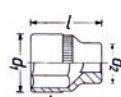

- □ drive 25 = 1"
- With knurling
- For manual operation
- With locking pin
- Surface: phosphated
- DIN 3124, ISO 2725-1

Made in Germany

HAZET No.	l mm	d ₁ mm	d ₂ mm	t mm	EAN-No. 4000896+
1104 S-32	270	48.5	54	30.5	002665

Handle Bar



- With ball and pin locking device
- For sliding head HAZET 1115-1 or ratchet head HAZET 1116
- Surface: chrome-plated

Made in Germany

HAZET No.	l mm	EAN-No. 4000896+
1114	700	003150

Sliding Head



- ■ drive 25 = 1"
- With locking ball
- For handle bar HAZET 1114
- Surface: chrome-plated, polished

HAZET No.	l mm	EAN-No. 4000896+
1115-1	80	003167

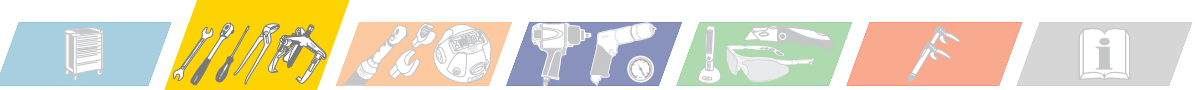

Handle Bar with Sliding Head



- drive 25 = 1"
- 2 pieces: handle bar HAZET 1114 and sliding head HAZET 1115-1
- Surface: chrome-plated, polished
- **Made in Germany**

HAZET No.	l mm	EAN-No. 4000896+
1114	1115-1	
1115/2	700	003181

Reversible Ratchet Head



- drive 25 = 1"
- with ball and pin locking device
- Shank with locking pin
- Ratchet wheel 32 teeth
- Surface: chrome-plated
- **Made in Germany**

HAZET No.	l mm	EAN-No. 4000896+
1116	195	003198

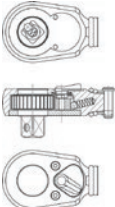

Replacement Set for shift lever
consisting of: shift lever, screws, ball, compression spring for 1116, 6150-1 CT, 6160-1 CT
1116/6 - 003228

Replacement set for ratchet wheel 25 = 1"
consisting of: shift lever, screws, ball, compression spring, pawl, ratchet wheel for 1116, 6160-1 CT
1116/8 N - 003235

Reversible Ratchet with Handle Bar



- drive 25 = 1"
- Surface: chrome-plated, polished
- DIN 3122, ISO 3315
- **Made in Germany**

HAZET No.	l mm	EAN-No. 4000896+
1114	1116	
1116/2	824	003211

Extension



- drive 25 = 1"
- with ball and pin locking device
- with locking pin
- Surface: chrome-plated, polished
- DIN 3123, ISO 3316
- **Made in Germany**

HAZET No.	l mm	EAN-No. 4000896+
1117- 8	200	003259
1117-16	400	003242

Impact Extension



- For impact operation
- drive 25 = 1"
- Surface: phosphated
- **Made in Germany**

HAZET No.	l mm	EAN-No. 4000896+
1105 S- 7	180	002702
1105 S-13	330	002696

Universal Joint



- drive 25 = 1"
- with ball and pin locking device
- with locking pin
- Surface: chrome-plated
- **Made in Germany**

HAZET No.	l mm	EAN-No. 4000896+
1121	144	003273

Impact Ball Joint



- For impact operation
- drive 25 = 1"
- Surface: burnished
- **Made in Germany**

HAZET No.	l mm	EAN-No. 4000896+
1106 S	125	002719

Adapter



- drive 25 = 1"
- with locking pin
- drive 20 = 3/4"
- with ball and pin locking device
- Surface: chrome-plated
- DIN 3123, ISO 3316
- **Made in Germany**

HAZET No.	l mm	EAN-No. 4000896+
1158-2	70	003297



- drive 25 = 1"
- drive 20 = 3/4"
- Surface: phosphated
- **Made in Germany**

HAZET No.	l mm	EAN-No. 4000896+
1107 S	70	002733

O-Ring and Connecting Pin



For all 25 = 1" connections
Made in Germany

HAZET No.	S mm	EAN-No. 4000896+
1100 S-G 2260	Ø 45x7	002382
1100 S-H 2260	Ø 5x45	002399

Socket Set (12-Point)



- drive 25 = 1"
- In sheet metal box (HAZET-blue)
- 17 pieces
- **Made in Germany**

Contents:

HAZET No.	l mm	EAN-No. 4000896+
1100 Z-32	36 41 46 50 55 60 65 70 75 80	
1114	1115-1 1116 1117-8 16 1121	
1100 Z		002504



HAZET – TORX® Tools

- ✓ Screw Driving Tool Sets
- ✓ Double Box-End Wrenches from page 66 on
- ✓ TORX® *HEXAnamic* Screwdrivers from page 109 on
- ✓ TORX® *trinamic*® Screwdrivers from page 110 on
- ✓ Sockets 123 from page 73 on
- ✓ Offset Screwdriver Sets from page 114 on
- ✓ Screwdriver Bits from page 116 on



Comparison

Hexagon Profile

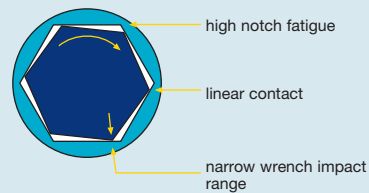

HAZET TORX®

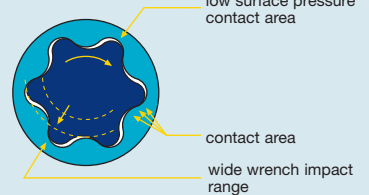

Advantages of TORX® Tools and Screws:

- The transmission of torque depends on the cross section and the hardness only – there is no limitation of the transmission of torque due to the drive profile (e.g. 6-point profile)
- When tightening the screw, the force is transmitted between surfaces reducing considerably the deformation of the drive profile (notch effect): this reduces the wear of the tool and provides a longer serviceable life.
- The heads of TORX® screws can be kept smaller than those of conventional screws. This provides space-saving solutions particularly in areas with restricted access.
- The TORX® profile ensures that the tool is always introduced vertically into the screw and prevents the cam-out effect.

TORX® is the trademark of the Co. Acument Intellectual Properties LLC.

HAZET® is licensee for the manufacture of TORX® tools

TORX® Screw Driving Tool Set

- □ drive 6.3 = ¼" and 12.5 = ½"
- Common tools for **inside and outside TORX® screws**
- In sheet metal box (HAZET-blue)
- With plastic insert
- **64 pieces**
- **Made in Germany**

Contents:

- 609-E 6 x E 8 E 10 x E 12
E 14 x E 18 E 20 x E 24
- 803-T 6 T 8 T 10 T 15 T 20 T 25 T 30
- 850-E 4 E 5 E 6 E 8 E 10
- 850 S-E 4 E 5 E 6 E 8 E 10
- 900-E 10 E 12 E 14 E 18 E 20 E 24
- 900 S-E 10 E 12 E 14
E 18 E 20 E 24
- 992-T 40 T 45 T 50 T 55 T 60
- 995 S-T 30 T 40 T 50 T 55 T 60
- 2115-T 8 T 10 T 15 T 20
T 25 T 27 T 30
- T 45 T 50 T 55 T 60
- 2223-T 8 T 9 T 10 T 15
T 20 T 25 T 30
- 2224-T 40 T 45 T 50



435 x 215 x 62 mm

HAZET No.	EAN-No. 4000896+
1555/64	003679

TORX® Tools

TORX® Screw Driving Tool Set



167 x 97 x 37 mm

- □ drive 6.3 = ¼", 10 = ⅜" and 12.5 = ½"
- For outside TORX® screws
- In plastic box
- With PUR foam insert
- **9 pieces**
- **Made in Germany**

Contents:

850-E 4 E 5 E 6
880-E 8 E 10 E 12
900-E 14 E 18 E 20

HAZET No.

1557/9

EAN-No. 4000896+

003907



TORX® Screw Driving Tool Set



344 x 188 x 56 mm

- For inside and outside TORX® screws
- In plastic box
- With PUR foam insert
- **21 pieces**
- **Made in Germany**

Contents:

880-E 5 E 6 E 7 E 8
E 10 E 11 E 12 E 14
8802-T 15 T 20 T 25 T 27
T 30 T 40 T 45 T 50
8815 8816 P 8820 8821-3 6

HAZET No.

1557/21

EAN-No. 4000896+

003822



TIN



185 x 153 x 52 mm

HAZET **SmartCase**
A clever solution

1/9

In SmartCase 165-S (1/9)

Safety-Insert-System, 2-component soft foam insert

- □ drive 6.3 = ¼", 10 = ⅜" and 12.5 = ½"
- For inside TORX® screws
- **10 pieces**
- **Made in Germany**

Contents:

8502-T 8 T 10 T 15
8802-T 20 T 25 T 30
992-T 40 T 50 T 55 T 60

HAZET No.

1557/10

EAN-No. 4000896+

003716



HAZET No.

1557/21

EAN-No. 4000896+

003822



279 x 121 x 47 mm

- For inside and outside TORX® screws
- In plastic box
- With PUR foam insert
- **29 pieces**
- **Made in Germany**

Contents:

609-E 6 x E 8 E 10 x E 12 E 14 x E 18 E 20 x E 24
850-E 5 E 6 E 7 E 8
880-E 10 E 12 E 14
900-E 10 E 12 E 14
992-T 55 T 60
2223-T 10 T 20 T 25 T 27 T 30
2223-T 30 H 2223 Lg-T 25
2224-T 40 T 45 T 50
2250-1 3 5

HAZET No.

1557/29

EAN-No. 4000896+

003846



Hand Tools - TORX® Tools

TORX® Screw Driving Tool Set



187 x 125 x 39 mm

- Equipped with 2 bits of each size
- For inside TORX® screws
- In plastic box
- With PUR foam insert
- 32 pieces

Made in Germany

Contents:

2223-T 6 T 7 T 8 T 9 T 10
 T 15 T 20 T 25 T 27 T 30 à 2
 2224-T 40 T 45 T 50 T 55 à 2
 2250-1 2 3 5

HAZET No.

1557/32

E 6.3 1/4"



TORX® Screw Driving Tool Set

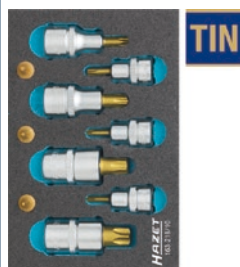

TIN

6.3 1/4" 10 3/8 12.5 1/2"



Made in Germany

HAZET No.

10 pieces in soft foam insert Safety-Insert-System (for SmartCase S 1/9)

Contents:

8502-T 8 T 10 T 15
 8802-T 20 T 25 T 30
 992-T 40 T 50 T 55 T 60

163-218/10

EAN-No. 4000896+

168248

TORX® Tool Set



12.5 1/2"



Made in Germany

HAZET No.

12 pieces in soft foam insert Safety-Insert-System (for SmartCase S 1/9)

Contents:

900-E 10 E 12 E 14 E 16 E 18 E 20
 992-T 30 T 40 T 45 T 50 T 55 T 60

163-245/12

178049

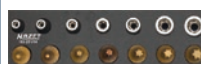

6.3 1/4"



Made in Germany

HAZET No.

14 pieces in soft foam insert Safety-Insert-System (172 x 50 mm)

Contents:

850-E 4 E 5 E 6 E 7 E 8 E 10 E 11
 8502-T 10 T 15 T 20 T 25 T 27 T 30 T 40

163-251/14

178063



10 3/8"



Made in Germany

HAZET No.

9 pieces in soft foam insert Safety-Insert-System (172 x 50 mm)

Contents:

880-E 8 E 10 E 12 E 14
 8802-T 25 T 30 T 40 T 45 T 50

163-252/9

178070



410 x 216 x 65 mm

- For inside and outside TORX® screws
- In plastic box
- With PUR foam insert
- 58 pieces

Made in Germany

Contents:

609-E 6 x E 8 E 10 x E 12 E 14 x E 18 E 20 x E 24
 803-T 6 T 7 T 8 T 9 T 10
 T 15 T 20 T 25 T 27 T 30
 850-E 4 E 5 E 6 E 7 E 8
 880-E 10 E 11 E 12 E 14
 8802-T 40 T 45
 900-E 16 E 18 E 20 E 24
 992-T 50 T 55 T 60
 2115-T 6 T 7 T 8 T 9 T 10 T 15
 T 20 T 25 T 27 T 30 T 40
 2223-T 6
 2223-T 7 H T 8 H T 9 H T 10 H T 15 H
 T 20 H T 25 H T 27 H T 30 H T 40 H
 2223 Lg-T 25
 2250-1 2 2264

HAZET No.

1557/58

EAN-No. 4000896+

003884