

Carrier
V2682, EAN 4047728026826
• For carrying unwieldy objects

Tragehilfe
V2682, EAN 4047728026826
• Zum Tragen von unhandlichen
Gegenständen

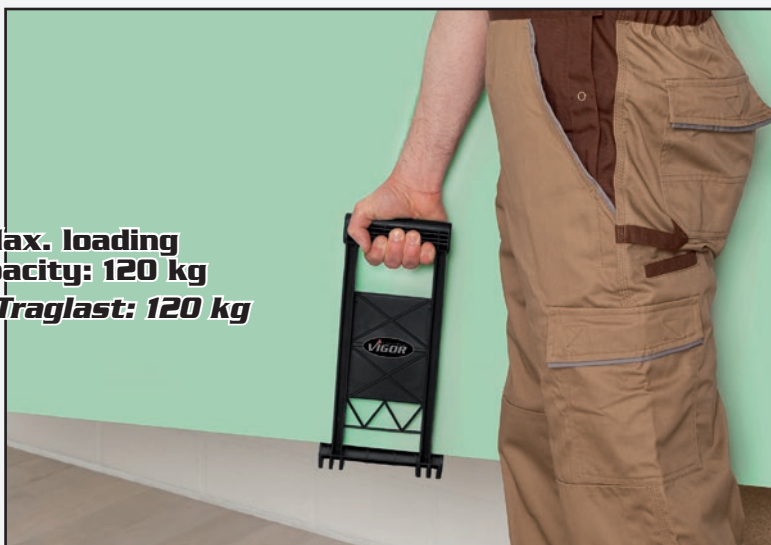

**Max. loading
capacity: 120 kg**
Max. Traglast: 120 kg



Battery carrier
V1435, EAN 4047728014359

Batterie-Tragegriff
V1435, EAN 4047728014359

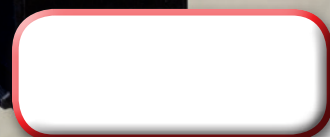
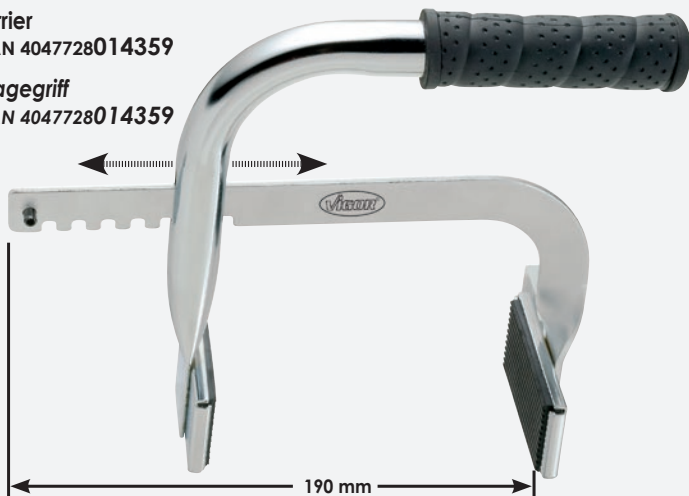

Battery cell tester
V1757, EAN 4047728017572
• For testing the battery voltage of the
generator and starter motor

Batterietester
V1757, EAN 4047728017572
• Zur Prüfung der Batteriespannung der
Lichtmaschine und des Anlasses

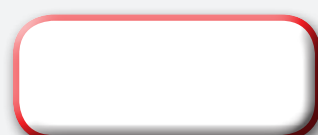
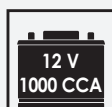
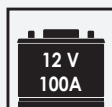
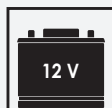

Battery and charging system tester with thermal printer

V3748, EAN 4047728037488

- Used for testing built-in batteries
- New: suitable for testing start-stop batteries
- With starter system and charging system test
- LCD display: voltage, battery capacity and battery capacity available in temperature measurements
- Operating range: 40 - 2000 A SAE 40 - 2000 A EN2 50 - 2500 A EN1 25 - 1300 A DIN 30 - 1500 A IEC

Batterietester und Ladesystem-Prüfgerät mit Thermodrucker

V3748, EAN 4047728037488

- Prüfung der Batterie im eingebauten Zustand
- Neu: Geeignet zum Testen von Start/Stop-Batterien
- Inkl. Anlasser- und Ladesystemtest
- LCD-Anzeige: Spannung, Batteriezustand sowie verfügbare Batteriekapazität unter Temperaturkompensation
- Arbeitsbereiche: 40 - 2000 A SAE 40 - 2000 A EN2 50 - 2500 A EN1 25 - 1300 A DIN 30 - 1500 A IEC



New: suitable for testing start-stop batteries
Neu: Geeignet zum Testen von Start/Stop-Batterien



Spare Thermal Paper Rolls
 Ersatz-Thermorollen-Paar
V1923, EAN 4047728019231



Car light tester

V1722, EAN 4047728017220

⚡ 6-24 V

Autolichtprüfer

V1722, EAN 4047728017220

⚡ 6-24 V

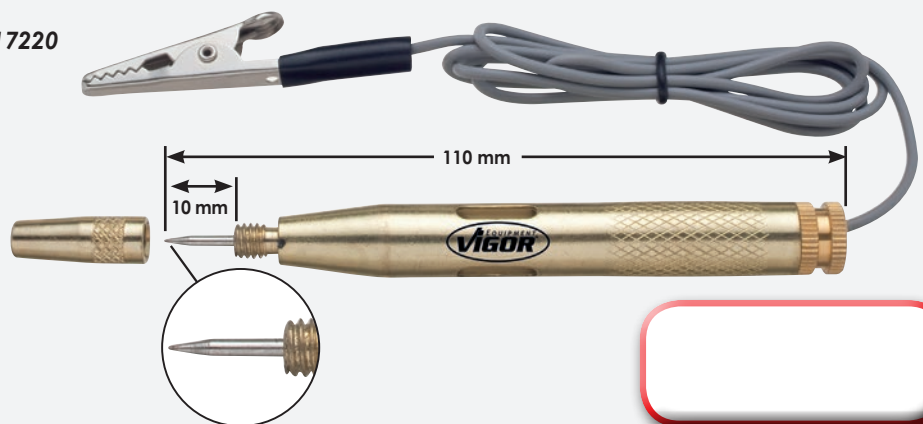

Hose clamp set

V3381, EAN 4047728033817

- For hoses with diameters up to 45 mm

Schlauchklemmen-Satz

V3381, EAN 4047728033817

- Für Schläuche mit Durchmesser bis 45 mm



Pipe locking tool set

V2510, EAN 4047728025102

- Pipe clamps and pipe stopping plugs for the locking of fuel lines, brake pipes, A/C pipes and power steering pipes

Rohrleitungsstopper-Satz

V2510, EAN 4047728025102

- Abklemmzangen und Stopfen zum Verschließen von Rohrleitungen für Kraftstoffsystem, Bremse, Klimaanlage und Servolenkung



Camshaft holding tool

V3771, EAN 4047728037716

- For safely fixing the camshaft sprocket
- Allows camshaft drive gears to be turned without disassembly
- Fibre-glass reinforced polyamide
- Very thin tool for optimal access in tight spaces

Nockenwellen-Arretierwerkzeug

V3771, EAN 4047728037716

- Zur sicheren Fixierung des Nockenwellenrades
- Ermöglicht das Drehen der Nockenwellen-Antriebsräder ohne Demontage
- Aus extrem starkem glasfaserverstärktem Polymer
- Sehr dünnes Werkzeug für optimalen Zugang bei engen Platzverhältnissen



V-ribbed belt tool assortment

V3571, EAN 4047728035712

- Made of glass reinforced nylon
- Most easy-to-use tool on the market
- No adjustment necessary
- Suitable for all kinds of flexible belts: air conditioning systems, generators as well as single and double groove belt pulleys



Keilrippenriemen Werkzeug-Sortiment

V3571, EAN 4047728035712

- Aus glasverstärktem Nylon
- Mit einfachster Handhabung auf dem Markt
- Keine Anpassung notwendig
- Passend für alle elastischen Riemenarten: Klimaanlage, Lichtmaschinen sowie einfache und doppelte Riemenscheiben

Assembly
Montage



Disassembly
Demontage





**New design
Neue Ausführung**



Cooling system diagnosis set V1963, EAN 4047728019637

- Complete set for service work on radiator and heating system
- Comprehensive range of adapters suitable for all common vehicles with water-cooled engines
- 3 features: pressure test (check for leaks in radiator system), refilling and cleaning
- Control of pressure loss via gauge
- Vacuum is generated in the radiator system. Advantage: coolant is sucked in without air bubbles
- Enables refilling of even large engines without thermal influences
- Universal usage due to conical rubber radiator adapter
- Measuring range: 0 up to 2.5 bar

- Contents:
 - 1 hand pump with gauge · hose · pressure release valve
 - 1 adapter, black, R123 · R124
 - 1 adapter, blue, R123 · R125
 - 1 cooling system bayonet adapter No. 3, large
 - 1 cooling system bayonet adapter No. 4, medium
 - 1 cooling system bayonet adapter No. 5, small
 - 13 cooling system screw adapters with inside threads M42 x 2.5 · M42 x 3.0 · M45 x 3.0 hollow M46 x 3.0 · M48 x 2.5 · M48 x 4.0 · M50 x 2.5 M50 x 2.5 hollow · M50 x 3.0 · M52 x 3.0 M60 x 4.0 mm
 - 3 cooling system screw adapters with outside threads M34 x 3.0 · M58 x 3.0 · M62 x 3.0 mm
 - 1 vacuum filling unit with gauge up to 76 cm HG = 1 bar
 - 1 rubber cone adapter, 45-14 mm, length: 75 mm
 - 1 thermometer, 0-220° C · 0-400° F

Kühlersystem-Diagnose-Satz V1963, EAN 4047728019637

- Kompletter Satz für Servicearbeiten am Kühlsystem und an der Heizung
- Umfangreiche Adapterauswahl passend für alle gängigen Fahrzeuge mit wassergekühlten Motoren
- 3 Funktionen: Kühler abdrücken (Kontrolle auf Undichtigkeiten), befüllen und reinigen
- Druckverlustkontrolle über Manometer
- Befüllen erzeugt Vakuum im Kühlkreislauf. Vorteil: Blasenfreies Einsaugen der Flüssigkeit
- Problemlose Befüllung auch größerer Motoren ohne thermische Schwachpunkte
- Füllsystem universell adaptierbar durch konischen Gummianschluss-Stutzen
- Messbereich: 0 bis 2,5 bar

- Inhalt:
 - 1 Handpumpe mit Manometer · Schlauch · Druckablass-Ventil
 - 1 Deckel-Prüfadapter, schwarz, R123 · R124
 - 1 Deckel-Prüfadapter, blau, R123 · R125
 - 1 Kühlsystem-Bajonettadapter Nr. 3, groß
 - 1 Kühlsystem-Bajonettadapter Nr. 4, mittel
 - 1 Kühlsystem-Bajonettadapter Nr. 5, klein
 - 13 Kühlsystem-Schraubadapter mit Innengewinde M42 x 2.5 · M42 x 3.0 · M45 x 3.0 hohl · M46 x 3.0 · M48 x 2.5 · M48 x 4.0 · M50 x 2.5 · M50 x 2.5 hohl · M50 x 3.0 · M52 x 3.0 · M60 x 4.0 mm
 - 3 Kühlsystem-Schraubadapter mit Außengewinde M34 x 3.0 · M58 x 3.0 · M62 x 3.0 mm
 - 1 Vakuum-Füllereinheit mit Manometer bis 76 cm HG = 1 bar
 - 1 Gummikonus-Adapter, 45-14 mm, Länge: 75 mm
 - 1 Thermometer, 0-220° C · 0-400° F

**+ 2 adapters
2 Adapter**

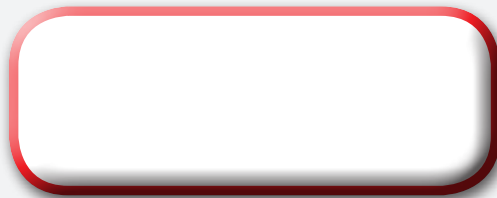

Vacuum filling unit V4202, EAN 4047728042024

Vakuum-Befüllereinheit
V4202, EAN 4047728042024



Hand pump with manometer V3729, EAN 4047728037297

Handpumpe mit Manometer
V3729, EAN 4047728037297



Radiator tester set for commercial vehicles

V3596, EAN 4047728035965

- Assortment with pump and 7 radiator adapters
- Suitable for common heavy goods vehicles from DAF, IVECO, MERCEDES-BENZ, MAN, SCANIA, RENAULT and Volvo
- Measuring range: 0–2.5 bar
- Control of pressure loss via gauge
- Test options for locking caps
- Pressure test of the radiator
- Contents:
 - 1 pump
 - 1 hose
 - 7 adapters



Kühlsystem-Diagnosekoffer Nfz

V3596, EAN 4047728035965

- Sortiment mit Pumpe und 7 Kühleradaptoren
- Geeignet für gängige Lkw von DAF, IVECO, MERCEDES-BENZ, MAN, SCANIA, RENAULT und Volvo
- Messbereich: 0–2,5 bar
- Druckverlustkontrolle über Manometer
- Prüfmöglichkeit von Verschlusskappen
- Druckprüfung des Kühlsystems
- Inhalt:
 - 1 Pumpe
 - 1 Schlauch
 - 7 Adapter



M42 x 3.0



M45 x 3.0



M52 x 3.0



M45 x 4.0



M62 x 4.0



M72 x 4.0

Anti-freeze tester

V1586, EAN 4047728015868

- For testing ethylene glycol coolant (anti-freeze) density in passenger cars, trucks, etc.

Frostschutz-Prüfer

V1586, EAN 4047728015868

- Für Ethylenglykol-Wassermischungen an Kühlkreisläufen in Pkw, Lkw usw.



Refractometer

V2459, EAN 4047728024594

- Quickly and accurately measures the anti-freeze concentration
- Application e.g. for coolant, screenwash, battery fluid and AdBlue
- Eyepiece with adjustable focus, equipped with rubber cup
- Left scale: control of the battery acid density measuring range 1100 up to 1300 sg / resolution 0.01 sg
- Middle scale: antifreeze based on propylene glycol G 13, measuring range -25 °C to -50 °C / resolution 5 °C, and antifreeze based on ethylene glycol G 11/G 12, measuring range -25 °C to -50 °C / resolution 5 °C
- Upper right scale: AdBlue (VRA) urea concentration, measuring range 30 % to 35 % / resolution 0.1 %
- Lower right scale: screenwash antifreeze SRF 1, measuring range -10 °C to -40 °C / resolution 1 °C
- In plastic case with soft foam insert
- Contents:
 - 1 x refractometer / 1 x calibration screwdriver / 1 x pipette

Refraktometer

V2459, EAN 4047728024594

- Zur schnellen und präzisen Überprüfung des Frostschutzgehaltes
- Anwendbar u.a. für Kühl- und Scheibenwasser, Batteriesäure und AdBlue
- Einstellbares Okular mit Gummi-Augenauflege
- Linke Skala: Kontrolle der Batteriesäuredichte Messbereich 1100 bis 1300 sg / Auflösung 0,01 sg
- Mittlere Skala: Frostschutz auf Basis Propylenglykol G 13 Messbereich -25° C bis -50° C / Auflösung 5° C sowie Frostschutz auf Basis Ethylenglykol G 11/ G 12 Messbereich -25° C bis -50° C / Auflösung 5° C
- Rechte Skala oben: AdBlue (VRA) Harnstoffgehalt Messbereich 30 % bis 35 % / Auflösung 0,1 %
- Rechte Skala unten: Frostschutz-Scheibenwaschflüssigkeit SRF 1 Messbereich -10° C bis -40° C / Auflösung 1° C
- In Kunststoffbox mit Weichschaum-Einlage
- Inhalt:
 - 1 x Refraktometer / 1 x Kalibrier-Schraubendreher / 1 x Pipette



**Injector sealing seat cleaning set
V2704, EAN 4047728027045**

- Universal injector seat sealing and milling set
- For HDi engines, diesel direct injection and common rail engines with Bosch and Delphi injectors
- Shaft cleaning with wire brushes, machine operation

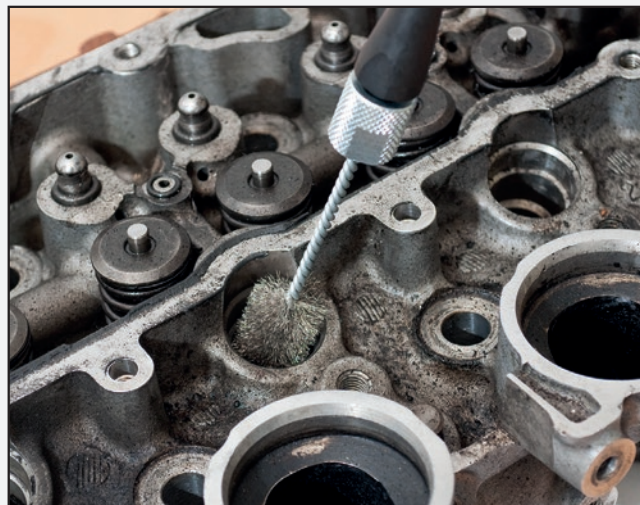

**Injektorschacht-Reinigungs-Satz
V2704, EAN 4047728027045**

- Universal Injektor-Dichtsitz-Reinigung- und Fr sen-Satz
- Zur Verwendung an HDi-, Diesel-Direkt-einspritzung und Common-Rail-Motoren mit Bosch- und Delphi-Injektoren
- Schaffreinigung durch B rsten mit Maschinenantrieb



| No. Nr. | VIGOR No. | X | Designation | Bezeichnung | ← L → mm | EAN 4047728+ |
|---------|-----------|---|----------------------------------|--------------------------------|----------|--------------|
| ① | V3604 | 1 | Basic unit | Grundger t | 267 | 036047 |
| ② | V3572 | 1 | Sealing ring for distance plates | Unterlegscheiben-Dichtungsring | 230 | 035729 |
| ③ | V3573 | 1 | Adapter | Adapter | 294 | 035736 |
| ④ | V3574 | 1 | Brush | B rste | 300 | 035743 |
| ⑤ | V3575 | 1 | Brush | B rste | 85 | 035750 |
| ⑥ | V3576 | 1 | Threaded rod | Gewindestange | 200 | 035767 |
| ⑦ | V3577 | 1 | Drive | Antriebsst ck | 107 | 035774 |

| No. Nr. | VIGOR No. | X | Designation | Bezeichnung | ← L → mm | EAN 4047728+ |
|---------|-----------|---|-------------------------|--------------------------|----------|--------------|
| ⑧ | V3578 | 6 | Threaded coil M5x0.8 mm | Gewindespule M5 x 0,8 mm | 15.2 | 035781 |
| ⑨ | V3579 | 1 | Adapter   20.6 mm | Adapter   20,6 mm | 32 | 035798 |
| ⑩ | V3580 | 1 | Adapter   22 mm | Adapter   22 mm | 32 | 035804 |
| ⑪ | V3591 | 1 | Adapter   24.5 mm | Adapter   24,5 mm | 32 | 035910 |
| ⑫ | V3592 | 1 | Cutter   15/17 mm | Fr ser   15/17 mm | 39 | 035927 |
| ⑬ | V3593 | 1 | Cutter   19/17 mm | Fr ser   19/17 mm | 39 | 035934 |
| ⑭ | V3594 | 1 | Cutter   17 mm | Fr ser   17 mm | 39 | 035941 |

Generator socket set

V2835, EAN 4047728028356

- For working on the generator when fitted or removed
- E.g.: VW, AUDI, SEAT, SKODA, PORSCHE, MERCEDES-BENZ, FORD, RENAULT, Volvo, etc.
- For installing and removing the belt pulley on generators
- TORX® and XZN screwdriver sockets for different inside profiles
- The generator is locked using the respective socket and the belt pulley is bolted using the adapter with internal serration



**Lichtmaschinen
Steckschlüssel-Satz**

V2835, EAN 4047728028356

- Für Arbeiten an Lichtmaschine im ein- und ausgebauten Zustand
- Z.B.: VW, AUDI, SEAT, SKODA, PORSCHE, MERCEDES-BENZ, FORD, RENAULT, Volvo usw.
- Zur Demontage und Montage der Freilauf-Riemenscheibe an Lichtmaschinen
- TORX®- und XZN-Einsätze für unterschiedliche Innenprofile
- Zur Arretierung der Lichtmaschine über jeweiligen Einsatz und Verschraubung der Riemenscheibe über Vielzahnadapter

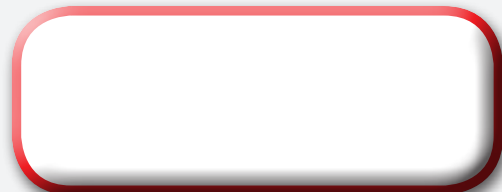
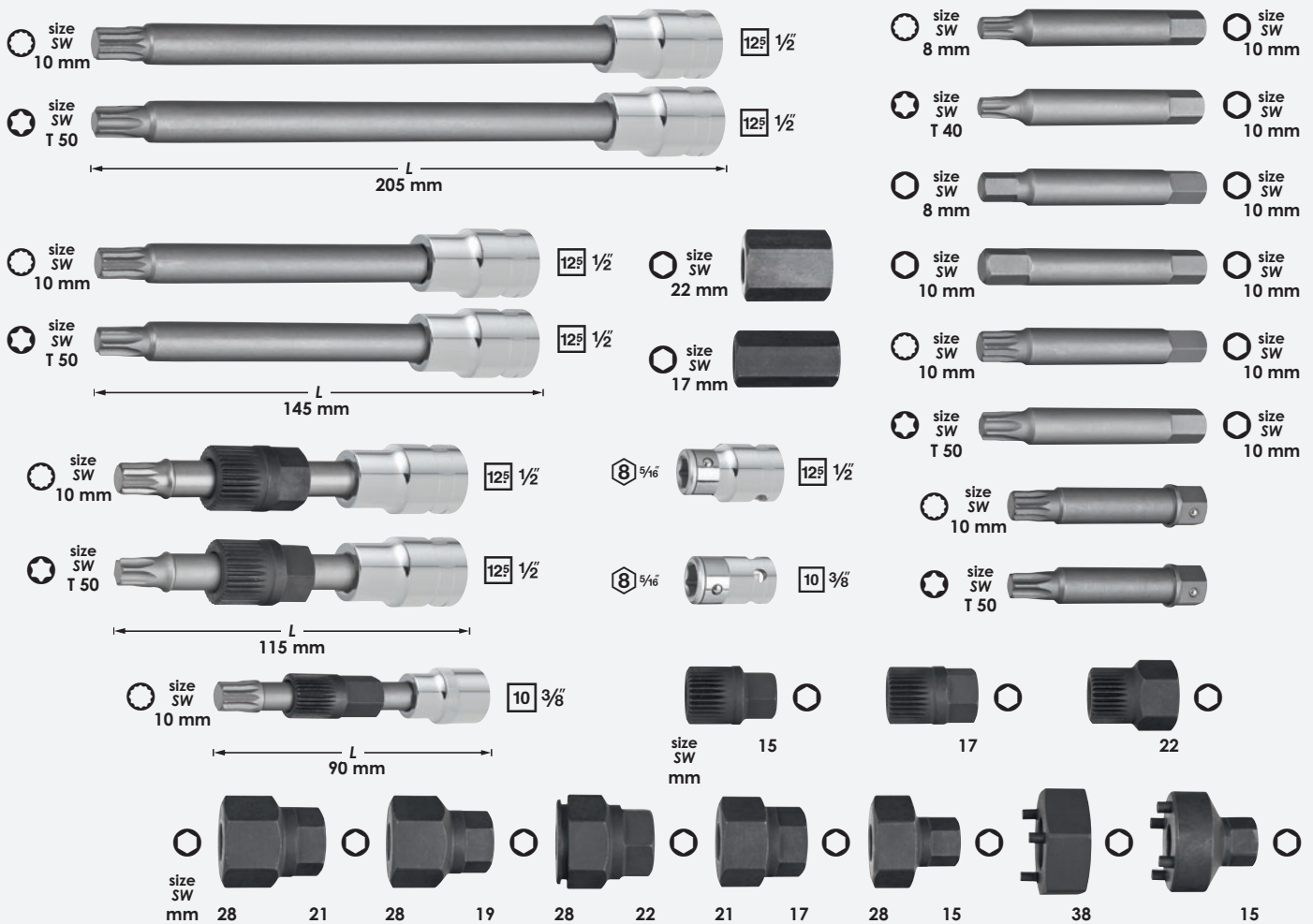

Turbo system pressure tester kit
V3595, EAN 4047728035958

- For fast diagnostics of the charging air system
- Enables time saving and appropriate determination of leaky intercoolers and invisible cracks in charging air hoses

• Contents:
1 manometer
Four pairs of stepped adapters
85-90, 75-80, 65-70, 55-60 mm

Turbosystem-Abdrücker-Satz
V3595, EAN 4047728035958

- Zur schnellen Diagnose des Ladeluftsystems
- Ermöglicht zeitsparende und fachgerechte Ermittlung von undichten Ladeluftkühlern und nicht sichtbaren Rissen in Ladeluftschläuchen

• Inhalt:
1 Manometer
Vier Paar abgestufte Adapter
85-90, 75-80, 65-70, 55-60 mm



Incl. manometer
Inkl. Manometer

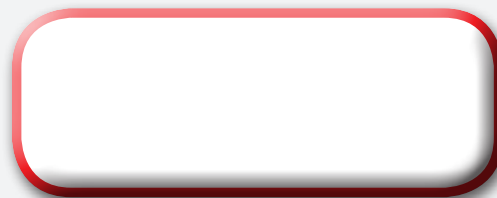

85 - 90 mm



75 - 80 mm



65 - 70 mm



55 - 60 mm



Manometer for turbo system pressure tester kit

V4233, EAN 4047728042338

- Suitable for V3595 and V4192

Manometer für Turbosystem-Abdrücker-Satz

V4233, EAN 4047728042338

- Geeignet für V3595 und V4192



Turbo system pressure tester set for click systems

V4192, EAN 4047728041928

- For the quick diagnosis of charging air systems in new generations of vehicles in which air pipes are connected with click systems
- Enables time saving and appropriate determination of leaking charging air hoses
- For performing leak tests using noise generation, leak detector spray or pressure drop
- Contents:
- 6 plug pairs 31 / 38 / 46 / 51 / 56 / 61 mm



Turbosystem-Abdrücker-Satz für Klicksysteme

V4192, EAN 4047728041928

- Zur schnellen Diagnose der Ladeluft-Systeme in neuen Fahrzeuggenerationen, bei denen Luftröhre mit Klicksystem verbunden werden
- Ermöglicht zeitsparende und fachgerechte Ermittlung von undichten Ladeluftschläuchen
- Zur Durchführung der Dichtheitsprüfung anhand von Geräuschenentwicklung, Lecksuchspray oder Druckabfall
- Inhalt:
- 6 Stopfen-Paare 31 / 38 / 46 / 51 / 56 / 61 mm



Without manometer
Ohne Manometer

Available in February
Erhältlich ab Februar



31 mm



38 mm



46 mm



51 mm



56 mm



61 mm



Manometer for turbo system pressure tester kit

V4233, EAN 4047728042338

- Suitable for V3595 and V4192

Manometer für Turbosystem-Abdrücker-Satz

V4233, EAN 4047728042338

- Geeignet für V3595 und V4192



Oil dipstick set MERCEDES-BENZ
V2112, EAN 4047728021128



- For measuring the level of engine and automatic gearbox oil
- Essential after each oil change (vehicle provided by the manufacturer without dipstick, only with sealing plug)

Ölmesststäbe-Satz MERCEDES-BENZ
V2112, EAN 4047728021128

- Zum Messen des Motor- und Automatikgetriebe-Ölstandes
- Unverzichtbar nach Ölwechsel (Fahrzeugauslieferung werksseitig ohne Messstäbe, sondern nur mit Verschlussstopfen)

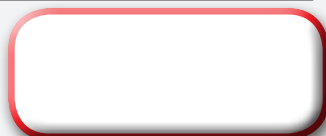
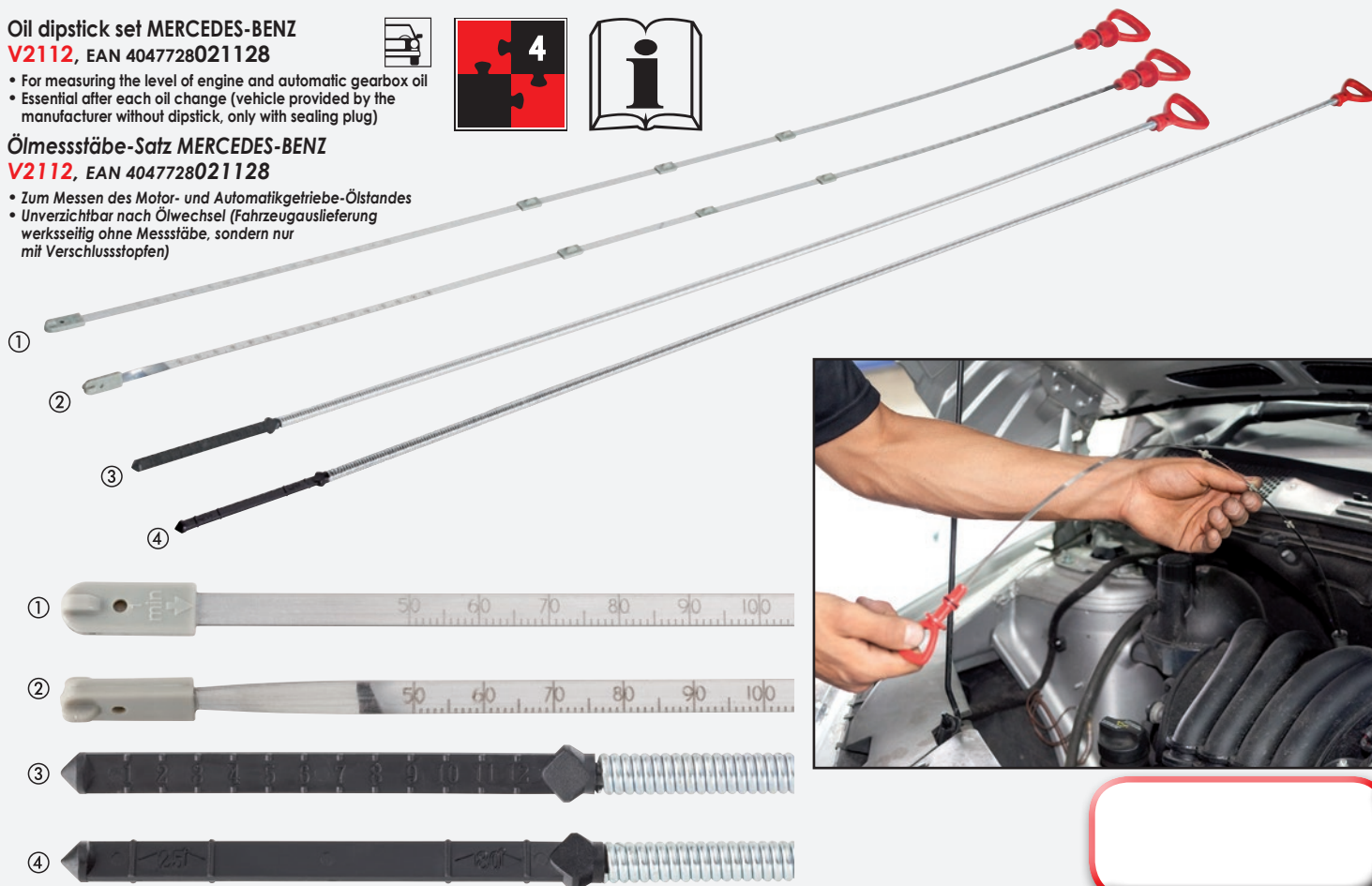

Oil dipstick AUDI

V2645, EAN 4047728026451



- For models with oil level indicator on the display (no dipstick in the engine)
- For checking the level after oil change and subsequent comparison with the display
- Helpful after replacing the oil sensor or calibrating the indicator in the driver's display (comparable to T40178)
- Application: for AUDI A4 / A5 / A6 with engines 1.8, 2.0 TFSI / 3.0, 3.2 FSI / 2.0, 2.7, 3.0 TDI, among others

Ölmesststab AUDI

V2645, EAN 4047728026451

- Für Modelle mit Ölstandsanzeige im Display (kein Peilstab am Motor)
- Zum Kontrollieren des Füllstands nach Ölwechsel und anschließendem Vergleich mit Displayanzeige
- Hilfreich nach Tausch des Ölsensors oder Kalibrierung der Anzeige im Fahrerdisplay (vergleichbar T40178)
- Anwendung: u.a für AUDI A4 / A5 / A6 mit Motoren 1.8, 2.0 TFSI / 3.0, 3.2 FSI / 2.0, 2.7, 3.0 TDI

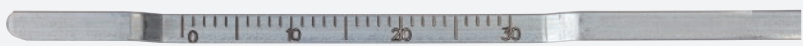
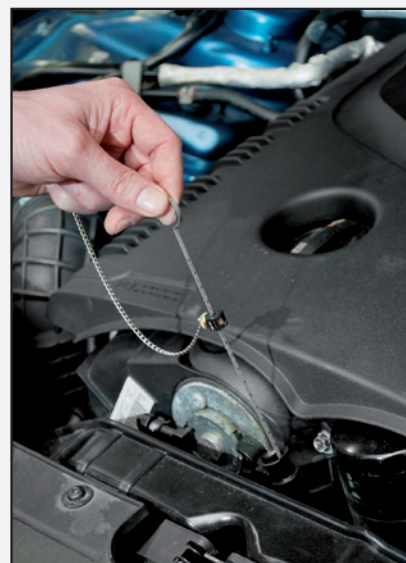
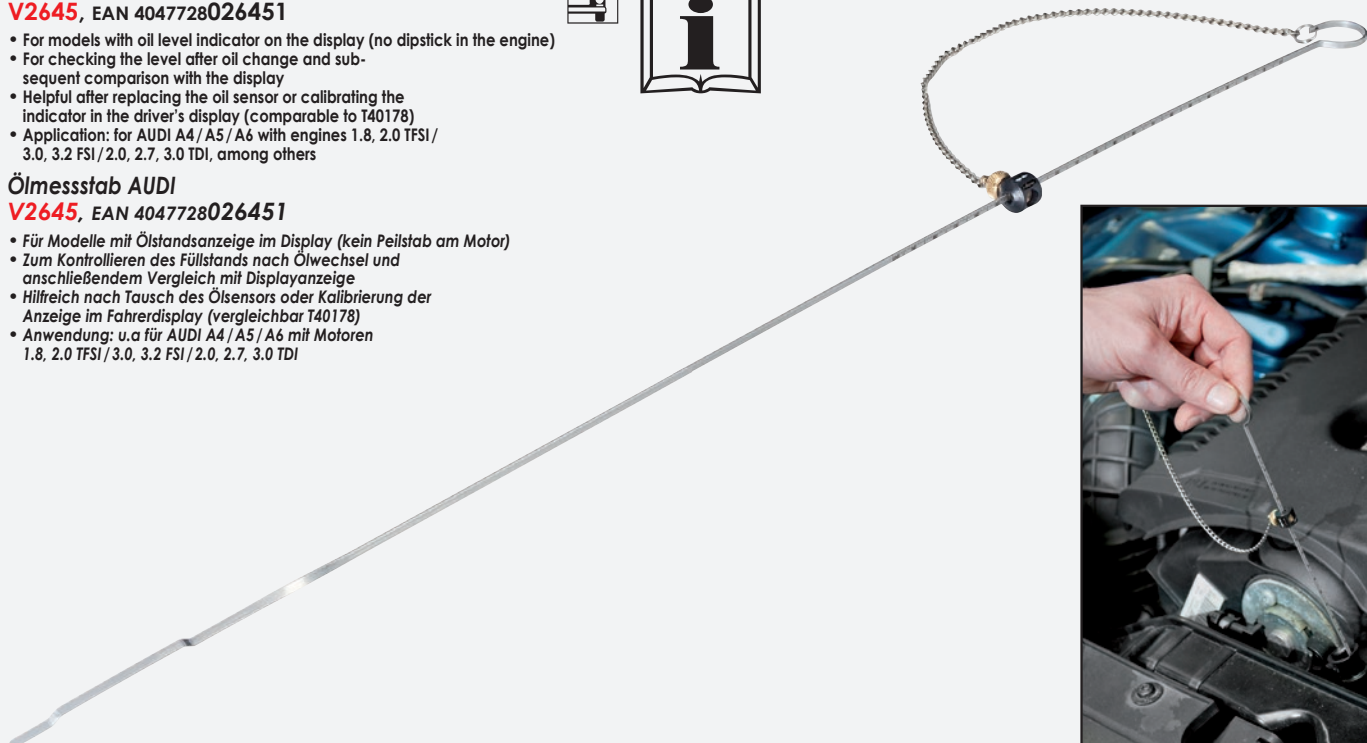

Oil filter wrench set

V1282, EAN 4047728012829

- 14 Oil filter wrenches
- 1 adapter $\frac{1}{2}$ " outside square / $\frac{1}{2}$ " inside square, with outside hexagon size 21 mm



Ölfilterschlüssel-Satz

V1282, EAN 4047728012829

- 14 Ölfilterschlüssel
- 1 Adapter $\frac{1}{2}$ " Außenvierkant / $\frac{1}{2}$ " Innenvierkant, mit Außensechskant SW 21 mm



| Ø mm | Step Stufe | Grooves Rillen | Surface Fläche | Vehicles Fahrzeuge |
|-------|------------|----------------|----------------|---|
| 65 | 1 | - | 14 | DAIHATSU, TOYOTA, NISSAN, FIAT |
| 65-67 | 1 | - | 14 | DAIHATSU, TOYOTA |
| 68 | 1 | - | 14 | MAZDA, FORD, SUBARU |
| 73 | 1 | - | 14 | TOYOTA, LEXUS |
| 74-76 | 2 | - | 15 | FORD, OPEL, VW, AUDI, MERCEDES-BENZ |
| 75-77 | 2 | - | 15 | VW, AUDI, ISUZU, MERCEDES-BENZ |
| 76 | - | - | 14 | VW, PORSCHE, MERCEDES-BENZ, BMW, AUDI, OPEL |
| 76 | 1 | 30 | - | FORD |
| 80 | 1 | - | 15 | NISSAN, HONDA, OPEL, MAZDA |
| 80-82 | 2 | - | 15 | SUBARU, TOYOTA, HONDA, NISSAN |
| 90 | 1 | - | 15 | HONDA, MITSUBISHI, ISUZU |
| 93 | 1 | - | 15 | MAZDA, Volvo, MITSUBISHI, NISSAN, HONDA |
| 93 | 1 | 36 | - | FORD |
| 100 | 1 | - | 15 | ISUZU, MITSUBISHI |

Oil filter strap wrench for passenger cars

V2511, EAN 4047728025119



Ölfilerbandschlüssel für den Pkw-Bereich

V2511, EAN 4047728025119



Spare strap
Ersatz-Spannband

V2521, EAN 4047728025218

Oil filter claw wrench for passenger cars

V1281, EAN 4047728012812



- Drive optionally:
- $\frac{1}{2}$ " Inside square
- $\frac{1}{2}$ " inside square or
- size 21 mm \bullet outside hexagon
- 1 adapter $\frac{1}{2}$ " outside square, $\frac{1}{2}$ " inside square, with outside hexagon size 21 mm

Ölfilerkralle für Pkw

V1281, EAN 4047728012812

- Antrieb wahlweise:
- $\frac{1}{2}$ " Innenvierkant,
- $\frac{1}{2}$ " Innenvierkant oder
- SW 21 mm \bullet Außensechskant
- 1 Adapter $\frac{1}{2}$ " Außenvierkant, $\frac{1}{2}$ " Innenvierkant, mit Außensechskant SW 21 mm

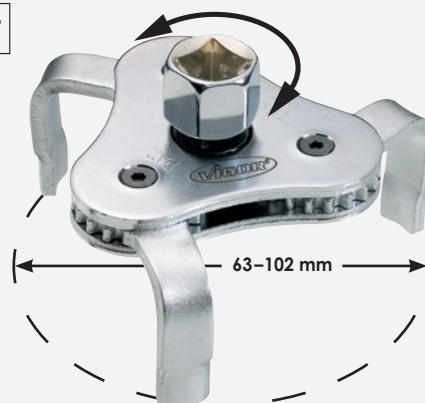

Multifunctional drain pan with castors, 30 litres, extra flat

V2681, EAN 4047728026819

- Suitable for oil, cooling fluid etc.

30 l Mehrzweckwanne mit Rollen, extraflach

V2681, EAN 4047728026819

- Geeignet für Öl, Kühlfüssigkeit etc.

Incl. anti-splash grille
Inkl. Sieb



Extra flat
Extra flach

Incl. 4 castors
Inkl. 4 Rollen



Axle oil drain pan for trucks

V3306, EAN 4047728033060

- For clean removal of the drive shaft
- Suitable for different wheel rim diameters
- Special-plastic material
- Dimensions: H 160 x W 310 x D 240 mm

Lkw-Achsölwanne

V3306, EAN 4047728033060

- Zur sauberen Demontage der Antriebswelle
- Passend für unterschiedliche Felgendurchmesser
- Spezial-Kunststoff
- Maße: H 160 x B 310 x T 240 mm



Vacuum pump

V4201, EAN 4047728042017

- Manual vacuum pump for extracting and filling vehicle fluids.
- Capacity: 1.5 l
- Suitable for the following fluids:
 - Diesel
 - Petrol
 - Brake fluid
 - Antifreeze
 - Engine oil
 - Gear oil
 - Power steering oil



Vakuumpumpe

V4201, EAN 4047728042017

- Manuelle Vakuumpumpe zum Absaugen und Einfüllen von Fahrzeugflüssigkeiten
- Kapazität: 1,5 l
- Geeignet für folgende Flüssigkeiten:
 - Dieselmotoren
 - Benzin
 - Bremsflüssigkeit
 - Frostschutz
 - Motoröl
 - Getriebeöl
 - Servolenkungöl



**Suitable for all fuel types
Geeignet für alle Kraftstoffe**



**Incl.
5 adapters
Inkl.
5 Adapter**



Oil drain hose

V2702, EAN 4047728027021

- When the adapter is screwed into the oil filter housing it opens a valve to allow controlled draining of oil from the oil filter housing
- No further customer complaints due to oily engines
- For VAG 1.8 l and 2.0 l petrol engines with engine codes AXW / BLX / BLR / BLY / BVX / BVY BVZ on:
 - AUDI A3 (8P1 / 8PA), A4 (8EC / 8ED / 8H7 / 8HE), A6 (4F2 / 4F5), TT (8J3 / 8J9),
 - SEAT Altea (5P1 / 5P5), Leon (1P1), Toledo 3 (5P2),
 - SKODA Octavia (1Z3 / 1Z5)
 - VW Jetta 3 (1K2), New Beetle (9C1 / 1C1 / 1Y7), Golf 5 and Eos (1K1 / 5M1), Passat (3C2 / 3C5), Touran (1T1 / 1T2)

Ölablass-Schlauch

V2702, EAN 4047728027021

- Adapter öffnet beim Einschrauben in das Ölfiltergehäuse ein Ventil und gewährleistet dadurch kontrolliertes Abfließen des Öls aus Ölfiltergehäuse
- Nie mehr Kundenreklamationen auf Grund verölter Motoren
- Für VAG 1,8 l und 2,0 l Benzinmotoren mit Motorkennbuchstaben AXW / BLX / BLR / BLY / BVX / BVY BVZ bei:
 - AUDI A3 (8P1 / 8PA), A4 (8EC / 8ED / 8H7 / 8HE), A6 (4F2 / 4F5), TT (8J3 / 8J9),
 - SEAT Altea (5P1 / 5P5), Leon (1P1), Toledo 3 (5P2),
 - SKODA Octavia (1Z3 / 1Z5)
 - VW Jetta 3 (1K2), New Beetle (9C1 / 1C1 / 1Y7), Golf 5 und Eos (1K1 / 5M1), Passat (3C2 / 3C5), Touran (1T1 / 1T2)



Length: 1000 mm
Länge: 1000 mm

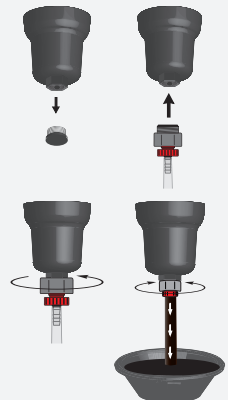

Oil filling device with adapter set
V2670, EAN 4047728026703

- For filling gearboxes and differentials with oil
- Incl. oil pan and 14 adapters for vehicles with extremely restricted installation spaces

Öl-Einfüllgerät mit Adapter-Satz
V2670, EAN 4047728026703

- Zum Befüllen von Getrieben und Differentialen mit Öl
- Inkl. Ölwanne und 14 Adapter für Fahrzeuge mit extrem beengten Bauräumen



| No. Nr. | VIGOR No. | Designation | Bezeichnung | EAN 4047728+ |
|---------|-----------|--|---|--------------|
| ① | V3681 | Adapter FORD with threaded connection | Adapter FORD mit Gewindeanschluss | 036818 |
| ② | V3682 | Adapter BMW bent | Adapter BMW abgelenkt | 036825 |
| ③ | V3683 | Adapter VAG short bent | Adapter VAG kurz abgelenkt | 036832 |
| ④ | V3684 | Adapter VAG long bent | Adapter VAG lang abgelenkt | 036849 |
| ⑤ | V3685 | Adapter VAG straight with threaded connection | Adapter VAG gerade mit Gewindeanschluss | 036856 |
| ⑥ | V3686 | Adapter MERCEDES-BENZ 7-speed automatic gearbox | Adapter MERCEDES-BENZ 7-Gang Automatik | 036863 |
| ⑦ | V3687 | Adapter VAG DSG direct shift gearbox | Adapter VAG DSG Direktschaltgetriebe | 036870 |
| ⑧ | V3688 | Adapter VAG CVT continuously variable transmission | Adapter VAG CVT stufenlose Automatik | 036887 |
| ⑨ | V3689 | Adapter Volvo straight | Adapter Volvo gerade | 036894 |
| ⑩ | V3690 | Adapter SKODA M 18 x 1.5 mm | Adapter SKODA M 18 x 1,5 mm | 036900 |
| ⑪ | V3691 | Adapter VW Passat from model year 2007 | Adapter VW Passat ab Bj. 2007 | 036917 |
| ⑫ | V4113 | Adapter TOYOTA, LEXUS 18 x 1.5 mm | Adapter TOYOTA, LEXUS 18 x 1,5 mm | 041133 |
| ⑬ | V4114 | Adapter Infiniti 7 Speed M8 x 1.0 for V2670 | Adapter Infiniti 7 Speed M8 x 1,0 für V2670 | 041140 |
| ⑭ | V4115 | Multifunction adapter | Multifunktions-Adapter | 041157 |



with 14 adapters
inkl. 14 Adapter



can also be ordered as spare part
auch als Ersatzteil bestellbar

Adapter Set for V2670
Adapter-Satz zu V2670
V3679, EAN 4047728036795



Viscosity up to SAE 140
Viskosität bis SAE 140

With return function
Mit Rücklauf-funktion

Hose length: 1600 mm
Schlauchlänge: 1600 mm

Contents: 7.5 l
Inhalt: 7,5 l



Incl. oil pan
Inkl. Ölwanne

Replacement container for oil filling device
V3550, EAN 4047728035507

Ersatzbehälter für Öl-Einfüllgerät
V3550, EAN 4047728035507



SAC Clutch SAC-Kupplung



SAC clutch alignment tool set V2306, EAN 4047728023061

- For almost all SAC (self-adjusting) clutches with 3 hole division
- For the fast and professional removal and installation of SAC clutches
- Without this tool set, correct installation is almost impossible
- With centring option of the clutch and resetting of the adjusting ring
- Prevents distortion of the adjusting ring in the clutch pressure plate
- For damage-free working on the pressure plate
- Avoids malfunctions (bad separating, slipping or judder)



SAC-Kupplungswerkzeug-Satz V2306, EAN 4047728023061

- Für nahezu alle selbstnachstellenden SAC-Kupplungen mit 3-Loch-Teilung
- Zur schnellen und fachgerechten Demontage und Montage der SAC-Kupplungen
- Korrekter Einbau nahezu unmöglich ohne diesen Werkzeugsatz
- Mit Zentriermöglichkeit der Kupplung und Rückstellen des Nachstellrings
- Verhindert das Verdrehen des Nachstellrings in der Kupplungsdruckplatte
- Ideal für beschädigungsfreies Arbeiten an der Druckplatte
- Funktionsstörungen (schlechtes Trennen, Rutschen oder Rupten) werden vermieden

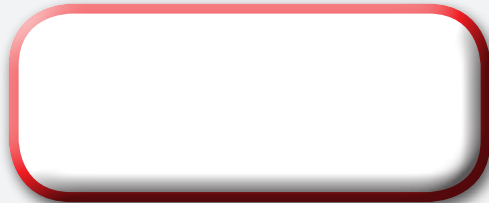
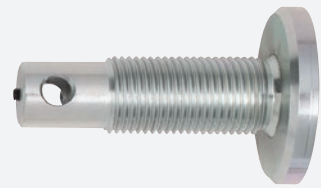

Expansion assortment for SAC clutch alignment tool V2308, EAN 4047728023085

- For example, for MERCEDES-BENZ A-Class



Erweiterung-Sortiment für SAC- Kupplungswerkzeug

V2308, EAN 4047728023085

- Zum Beispiel für MERCEDES-BENZ A-Klasse

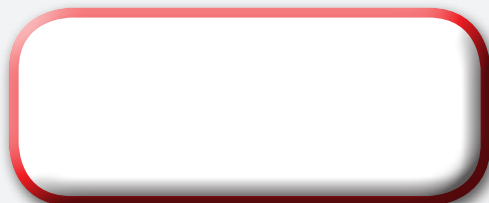

ABS reamer set

V3228, EAN 4047728032285

- Consisting of: fine-tooth reversible ratchet with hinge joint and quick-change function, for clockwise operation only, 5 reamers as well as one twist drill 10 mm Ø x 133 mm for reaming corroded and stuck sensors
- Note: when defective ABS sensors are replaced, residues of torn-off sensors may remain which are difficult to remove. For correct installation of new sensors, the seats of the sensors in the wheel bearing housing must be cleaned with the appropriate reamers



ABS-Reibahlen-Satz

V3228, EAN 4047728032285

- Bestehend aus ausschließlich nach rechts drehender, feinverzahnter Gelenkknarre mit Schnellwechselfunktion, 5 Reibahlen sowie Spiralbohrer 10 mm Ø x 133 mm zum Ausbohren von korrodierten und somit feststehenden Sensoren
- Hinweis: Beim Austauschen fehlerhafter ABS-Sensoren bleiben oft schwer zu entfernende Reste aufgrund abgerissener Sensoren zurück. Für ordnungsgemäßen Einbau neuer Sensoren, müssen die Sitze der Sensoren im Radlagergehäuse mit entsprechenden Reibahlen gereinigt werden



5 reamers:

- V3695** reamer Ø 10 mm x 150 mm:
VW Golf 5, Polo 9N, T5, SKODA Fabia, SEAT Ibiza, OPEL Insignia
- V3694** reamer Ø 14 mm x 32 mm:
BMW E38, E39, E52, E60, E61, E63, E64, E65, E66, E70, E71
- V3699** reamer Ø 15 mm x 23 mm:
MERCEDES-BENZ A class, MAZDA, FORD
- V3698** reamer Ø 18 mm x 23 mm:
AUDI, VW, BMW E36, E46, SEAT, SKODA
- V3697** reamer Ø 18 mm x 34 mm:
AUDI, VW, SEAT, SKODA, commercial vehicles

5 Reibahlen:

- V3695** Reibahle Ø 10 mm x 150 mm:
VW Golf 5, Polo 9N, T5, SKODA Fabia, SEAT Ibiza, OPEL Insignia
- V3694** Reibahle Ø 14 mm x 32 mm:
BMW E38, E39, E52, E60, E61, E63, E64, E65, E66, E70, E71
- V3699** Reibahle Ø 15 mm x 23 mm:
MERCEDES-BENZ A-Klasse, MAZDA, FORD
- V3698** Reibahle Ø 18 mm x 23 mm:
AUDI, VW, BMW E36, E46, SEAT, SKODA
- V3697** Reibahle Ø 18 mm x 34 mm:
AUDI, VW, SEAT, SKODA, Nutzfahrzeuge

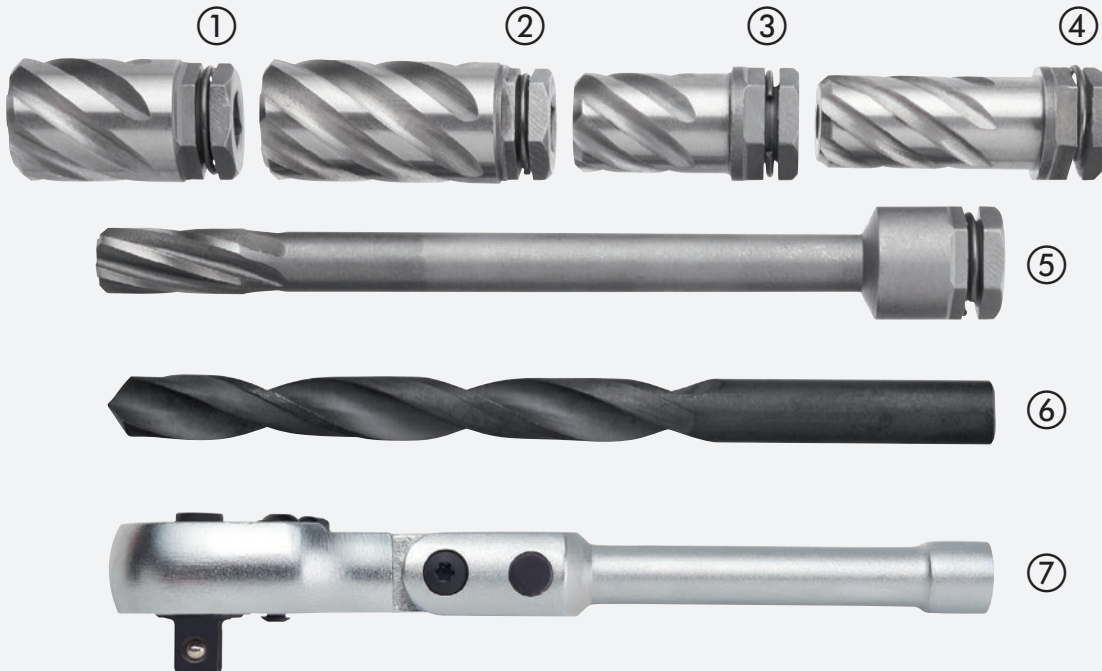

| No. Nr. | VIGOR No. | Designation | Bezeichnung | EAN 4047728+ |
|---------|-----------|---|---------------------------------------|--------------|
| ① | V3698 | Reamer Ø 18 x 23 mm | Reibahle Ø 18 x 23 mm | 036986 |
| ② | V3697 | Reamer Ø 18 x 34 mm | Reibahle Ø 18 x 34 mm | 036979 |
| ③ | V3699 | Reamer Ø 15 x 23 mm | Reibahle Ø 15 x 23 mm | 036993 |
| ④ | V3694 | Reamer Ø 14 x 32 mm | Reibahle Ø 14 x 32 mm | 036948 |
| ⑤ | V3695 | Drill (reamer) Ø 10 x 133 mm | Bohrer (Reibahle) Ø 10 x 133 mm | 036955 |
| ⑥ | V3696 | Drill (reamer) Ø 10 x 133 mm | Bohrer (Reibahle) Ø 10 x 133 mm | 036962 |
| ⑦ | V3693 | Reversible ratchet with hinge joint $\frac{33}{16}$ | Gelenk-Umschaltknarre $\frac{33}{16}$ | 036931 |

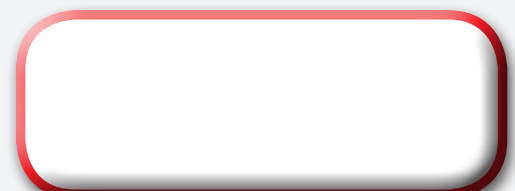

Tube flaring tool set

V1728, EAN 4047728017282

- Lightweight and easy to handle
- Especially suited for direct application on brake and hydraulic lines on vehicles
- For thin-walled pipes made of steel, aluminium and copper, metric/inch
- For convex and double flares (DIN/SAE-standards)
- No damage to coated lines



Bördelgerät-Satz

V1728, EAN 4047728017282

- Leicht und handlich
- Besonders für den direkten Einsatz an Brems- bzw. Hydraulikleitungen am Fahrzeug geeignet
- Für dünnwandige Stahl-, Aluminium- und Kupferleitungen Metrisch/Zoll
- Zur Anfertigung von Konvex und Doppelbördelungen (DIN/SAE-Standards)
- Keine Beschädigung beschichteter Leitungen



| No. Nr. | VIGOR No. | Designation | Bezeichnung | ∅ mm | EAN 4047728+ |
|---------|-----------|----------------------------|--------------------------|--------|--------------|
| ① | V2466 | Quick-change holder | Schnellwechsel-Halterung | — | 024662 |
| ② | V2559 | Basic unit | Grundgerät | — | 025591 |
| ③ | V2467 | Hydraulic spindle | Hydraulik-Spindel | — | 024679 |
| ④ | V2558 | Thrust block 90° DIN / SAE | Druckstück 90° DIN / SAE | 4.75-6 | 025584 |
| ⑤ | V2553 | Thrust block DIN / SAE | Druckstück DIN / SAE | 5 | 025539 |
| ⑥ | V2554 | Thrust block DIN / SAE | Druckstück DIN / SAE | 4.75 | 025546 |
| ⑦ | V2556 | Thrust block DIN / SAE | Druckstück DIN / SAE | 6 | 025560 |
| ⑧ | V2555 | Thrust block DIN / SAE | Druckstück DIN / SAE | 6 | 025553 |
| ⑨ | V2626 | Tube cutter, 3-22 mm | Rohrschneider, 3-22 mm | 3-16 | 026260 |
| ⑩ | V2551 | Pair of gripping jaws | Spannbacken-Paar | 5 | 025515 |
| ⑪ | V2552 | Pair of gripping jaws | Spannbacken-Paar | 6 | 025522 |
| ⑫ | V2540 | Pair of gripping jaws | Spannbacken-Paar | 4.75 | 025409 |
| ⑬ | V1782 | Tube bending tool | Rohrbieger | — | 017824 |

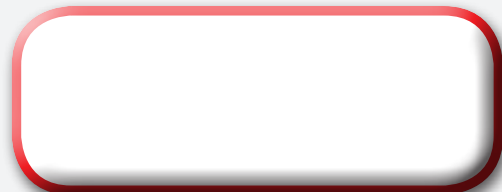

Brake and fuel line inspection tool

V2789, EAN 4047728027892

- With 12 cleaning edges for removal of dirt and rust from various lines
- Curved cleaning edges for working in areas with restricted access
- For the detection of hidden corrosion during general inspection
- 重量 0.1 kg

Inspektions-Werkzeug für Brems- und Kraftstoffleitungen

V2789, EAN 4047728027892

- Mit 12 Abstreifflächen zur Beseitigung von Schmutz und Korrosion verschiedener Leitungen
- Scharf gebogene Abstreifflächen ermöglichen Zugriff an schwer erreichbaren Stellen
- Zum Aufspüren verborgener Korrosionsstellen bei Hauptuntersuchung (HU)
- 重量 0.1 kg



200 mm



Brake calliper file

V2411, EAN 4047728024112

Bremssattel-Feile

V2411, EAN 4047728024112

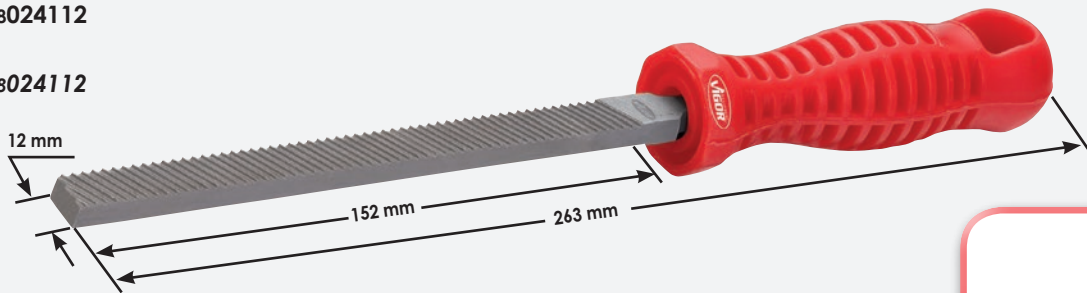

Steel brake calliper brush

V2250, EAN 4047728022507

- For removal of stubborn brake dust
- Allows access into small brake callipers

Bremssattel-Bürste, Stahl

V2250, EAN 4047728022507

- Zum Entfernen von hartnäckigem Bremsstaub
- Für enge Bremssattelschächte



With hanging hole
Mit Aufhängeloch

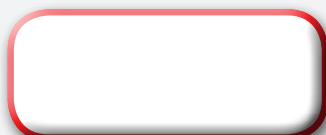

Brass brake calliper brush

V2249, EAN 4047728022491

- For cleaning aluminium brake callipers
- For removal of stubborn brake dust
- Allows access into small brake callipers

Bremssattel-Bürste, Messing

V2249, EAN 4047728022491

- Zum Reinigen von Aluminium-Bremssätteln
- Zum Entfernen von hartnäckigem Bremsstaub
- Für enge Bremssattelschächte



With hanging hole
Mit Aufhängeloch

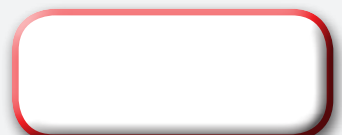

Brake line wrench set

V1805, EAN 4047728018050

- With hinge joint for working in areas with restricted access
- Especially suitable for application in areas with restricted and difficult access such as brake lines, air conditioning lines, power steering lines, vacuum lines, compressed air and fuel lines



Bremsleitungs-Schlüssel-Satz

V1805, EAN 4047728018050

- Mit Gelenk zur Anwendung an schwer zugänglichen Leitungsver schraubungen
- Besonders geeignet für den Einsatz unter beengten und schwierigen Platzverhältnissen wie z.B. an Brems-, Klima-, Servo-, Vakuum-, Druckluft- und Kraftstoffleitungen

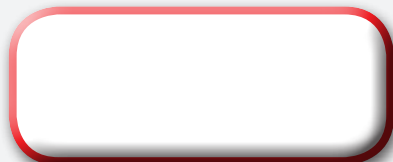

| VIGOR No. | Sizes (mm) SW (mm) | mm | EAN 4047728+ |
|-----------|-----------------------|-----|-----------------|
| V1841 | 8 x 9 | 120 | 018418 |
| V1842 | 10 x 11 | 160 | 018425 |
| V1843 | 12 x 13 | 180 | 018432 |
| V1844 | 14 x 15 | 210 | 018449 |



Special wave profile
Spezielles Wellenprofil

Tube bending tool

V1782, EAN 4047728017824

- For tubes made of copper, brass, aluminium and soft steel

Rohrbieger

V1782, EAN 4047728017824

- Für Kupfer-, Messing-, Alu- und Weichstahlrohre

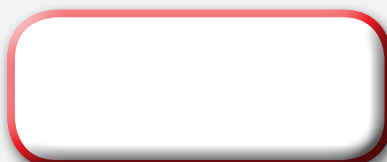

Line wrench set

V3730, EAN 4047728037303

- For screw connections on brake, fuel, hydraulic and air-conditioning lines
- Wrench heads work like spring hinges
- Worn, damaged or too small screw connections are firmly enclosed
- Clamping mechanism depending on torque:
- The higher the torque the more powerful the clamping
- Adapts to metric as well as inch sizes
- Drive 10 = 3/8" for extra leverage

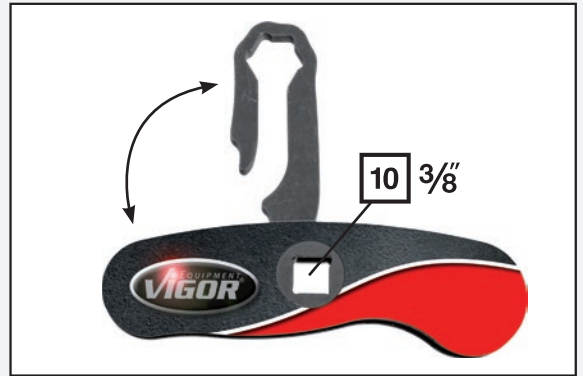

Leitungsschlüssel-Satz

V3730, EAN 4047728037303

- Für Verschraubungen an Brems-, Kraftstoff-, Hydraulik- und Klimaleitungen
- Schlüsselkopfen arbeiten wie Federscharniere
- Abgenutzte, beschädigte oder zu kleine Verschraubungen werden fest umschlossen
- Drehmomentabhängiger Klemm-Mechanismus:
- Je höher das Drehmoment, desto besser die Klemmung
- Passt sich sowohl metrischen als auch Zollgrößen an
- Antrieb 10 = 3/8" für extra Hebelwirkung



Size 14 mm
SW 14 mm
(9/16")

Size 12/13 mm
SW 12/13 mm
(1/2")

Size 11 mm
SW 11 mm
(7/16")

Size 10 mm
SW 10 mm
(3/8")

| VIGOR No. | Sizes (mm) SW (mm) | EAN 4047728+ |
|-----------|-----------------------|-----------------|
| V3703 | 10 | 037037 |
| V3704 | 11 | 037044 |
| V3705 | 12/13 | 037051 |
| V3706 | 14 | 037068 |





**Brake piston readjusting tool set
V3760, EAN 4047728037600**

- New system suitable for push-back and wind-back brake pistons
- Adapters enable use even on very worn brake linings and assembly of the back plate in the break calliper
- Contents:
 - 2 Thrust bolt assemblies (left-handed and right-handed)
 - 2 Allen keys (6 and 7 mm)
 - 2 Drift Pins
 - 3 Exchangeable reaction plates
 - 31 Reaction plates and adapters
 - 1 Lubricating oil



**Bremskolben-Rückstell Werkzeug-Satz
V3760, EAN 4047728037600**

- Neues System für links- und rechtsdrehende Kolben
- Adapter ermöglichen Einsatz auch bei stark abgefahrenen Belägen sowie den Zusammenbau der Rücksteller im Bremsattel
- Inhalt:
 - 2 Spindeln (links- und rechtsdrehend)
 - 2 Winkelschlüssel (6 und 7 mm)
 - 2 Splinttreiber
 - 3 austauschbare Rückhalteplatten
 - 31 Rückhalteplatten und Adapter
 - 1 Gewindeölf flasche

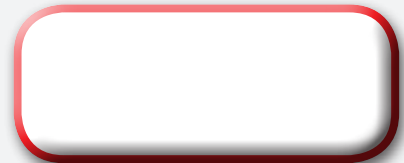

**Pneumatic brake piston readjusting tool set
V1711, EAN 4047728017114**

- Universal set for pushing and turning brake pistons on nearly all passenger cars
- Rotation possible to left and right
- Set with 16 pieces consisting of:
 - 1 pneumatic spindle and 15 adapter plates

**Pneumatischer Bremskolben-Rückstellwerkzeug-Satz
V1711, EAN 4047728017114**

- Universeller Satz zum Drehen und Drücken von Bremskolben an nahezu allen Pkw
- Drehbewegung rechts und links möglich
- 16-teiliger Satz bestehend aus:
 - 1 Druckluftspindel und 15 Adapterplatten

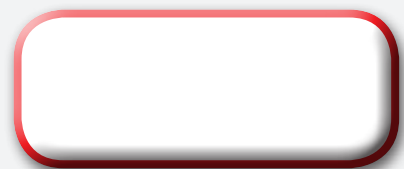

Four-way rim wrench
V1614, EAN 4047728016148

12⁵ 1/2" 

Kreuzschlüssel
V1614, EAN 4047728016148



Size / SW 17 mm
Size / SW 19 mm
Size / SW 21 mm
Size / SW 23 mm

To be used on both sides
Beidseitig einsetzbar



Four-way rim wrench
V4195, EAN 4047728041959

Kreuzschlüssel
V4195, EAN 4047728041959

12⁵ 1/2" 

Size 19 mm
SW 19 mm

- For passenger cars and vans
- Sizes: 17 x 19 x 21 mm x 1/2"
- Surface: chrome-plated
- DIN 3119

- Für Pkw und Transporter
- Größen: 17 x 19 x 21 mm x 1/2"
- Oberfläche: verchromt
- DIN 3119

12⁵ 1/2"



Size 17 mm
SW 17 mm



Size 21 mm
SW 21 mm



Bottle jack 2 t

V2479, EAN 4047728024792

- Suitable for vertical and horizontal applications

⚖️ 2,3 kg



Flaschenwagenheber 2 t

V2479, EAN 4047728024792

- Horizontaler und vertikaler Einsatz möglich

⚖️ 2,3 kg



2t

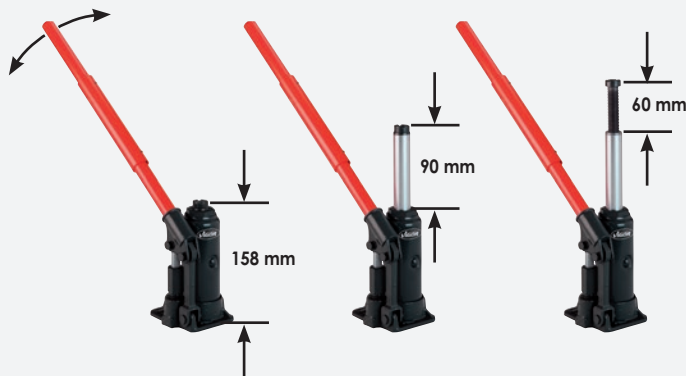

Bottle jack 6 t

V2478, EAN 4047728024785

- Suitable for vertical and horizontal applications

⚖️ 4,4 kg



Flaschenwagenheber 6 t

V2478, EAN 4047728024785

- Horizontaler und vertikaler Einsatz möglich

⚖️ 4,4 kg



6t





Hydraulic aluminium service jack 1.35 t
V2481, EAN 4047728024815

⚖️ 10 kg

Hydraulik Alu-Rangier-Wagenheber 1,35 t
V2481, EAN 4047728024815

⚖️ 10 kg

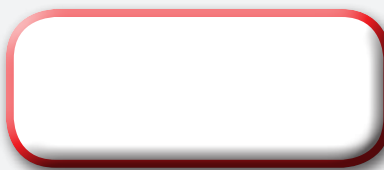

**Aluminium -
only 10 kg
Alu -
nur 10 kg**



| VIGOR No. | Designation | Bezeichnung | EAN 4047728+ |
|--------------|------------------------|-------------------|--------------|
| V2640 | Rubber pad | Gummi-Auflage | 026406 |
| V2632 | Pair of swivel castors | Lenkrollen-Paar | 026321 |
| V2631 | Pair of fixed castors | Bockrollen-Paar | 026314 |
| V2639 | Hydraulic unit | Hydraulik-Einheit | 026390 |

Hydraulic service jack 2 t
V2649, EAN 4047728026499



⚖️ 38 kg

Hydraulik-Rangier-Wagenheber 2 t
V2649, EAN 4047728026499

⚖️ 38 kg



Hydraulic service jack 3 t
V2480, EAN 4047728024808



⚖️ 42.0 kg

Hydraulik-Rangier-Wagenheber 3 t
V2480, EAN 4047728024808

⚖️ 42.0 kg



| VIGOR No. | Designation | Bezeichnung | EAN |
|--------------|------------------------|-------------------|--------|
| V3639 | Rubber pad | Gummi-Auflage | 036399 |
| V3638 | Pair of swivel castors | Lenkrollen-Paar | 036382 |
| V3637 | Pair of fixed castors | Bockrollen-Paar | 036375 |
| V3640 | Hydraulic unit | Hydraulik-Einheit | 036405 |

| VIGOR No. | Designation | Bezeichnung | EAN |
|--------------|------------------------|-------------------|--------|
| V2637 | Rubber pad | Gummi-Auflage | 026376 |
| V2633 | Pair of swivel castors | Lenkrollen-Paar | 026338 |
| V2634 | Pair of fixed castors | Bockrollen-Paar | 026345 |
| V2638 | Hydraulic unit | Hydraulik-Einheit | 026383 |

Jack stands 3 t
V2477, EAN 4047728024778

5.2 kg per pair

Unterstellböcke 3 t

V2477, EAN 4047728024778

5.2 kg pro Paar



3t

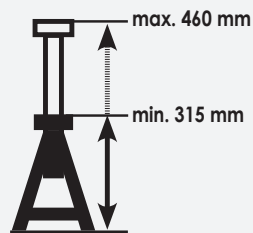

| VIGOR No. | Designation | Bezeichnung | EAN |
|--------------|-------------|---------------|--------|
| V2762 | Rubber pad | Gummi-Auflage | 027625 |

Jack stand set 6 t

V2648, EAN 4047728026482

11 kg per pair

Unterstellbock-Satz 6 t

V2648, EAN 4047728026482

11 kg pro Paar



6t

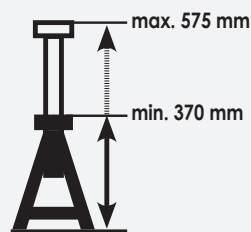

| VIGOR No. | Designation | Bezeichnung | EAN |
|--------------|-------------|---------------|--------|
| V2761 | Rubber pad | Gummi-Auflage | 027618 |



Tyre lever

V3564, EAN 4047728035644

- For passenger cars and vans
- Double-T profile ensures high stability
- Surface: chrome-plated
- Length: 500 mm

Reifen- und Montagehebel

V3564, EAN 4047728035644

- Für Pkw und Transporter
- Doppel-T-Profil für hohe Stabilität
- Oberfläche: verchromt
- Länge: 500 mm



Tyre lever with plastic coating

V3563, EAN 4047728035637

- For installing and removing tyres on steel and esp. on aluminium rims

Reifen- und Montagehebel

mit Kunststoff-Belag

V3563, EAN 4047728035637

- Zum Auf- und Abziehen der Reifen an Stahl- und insbesondere Alu-Felgen

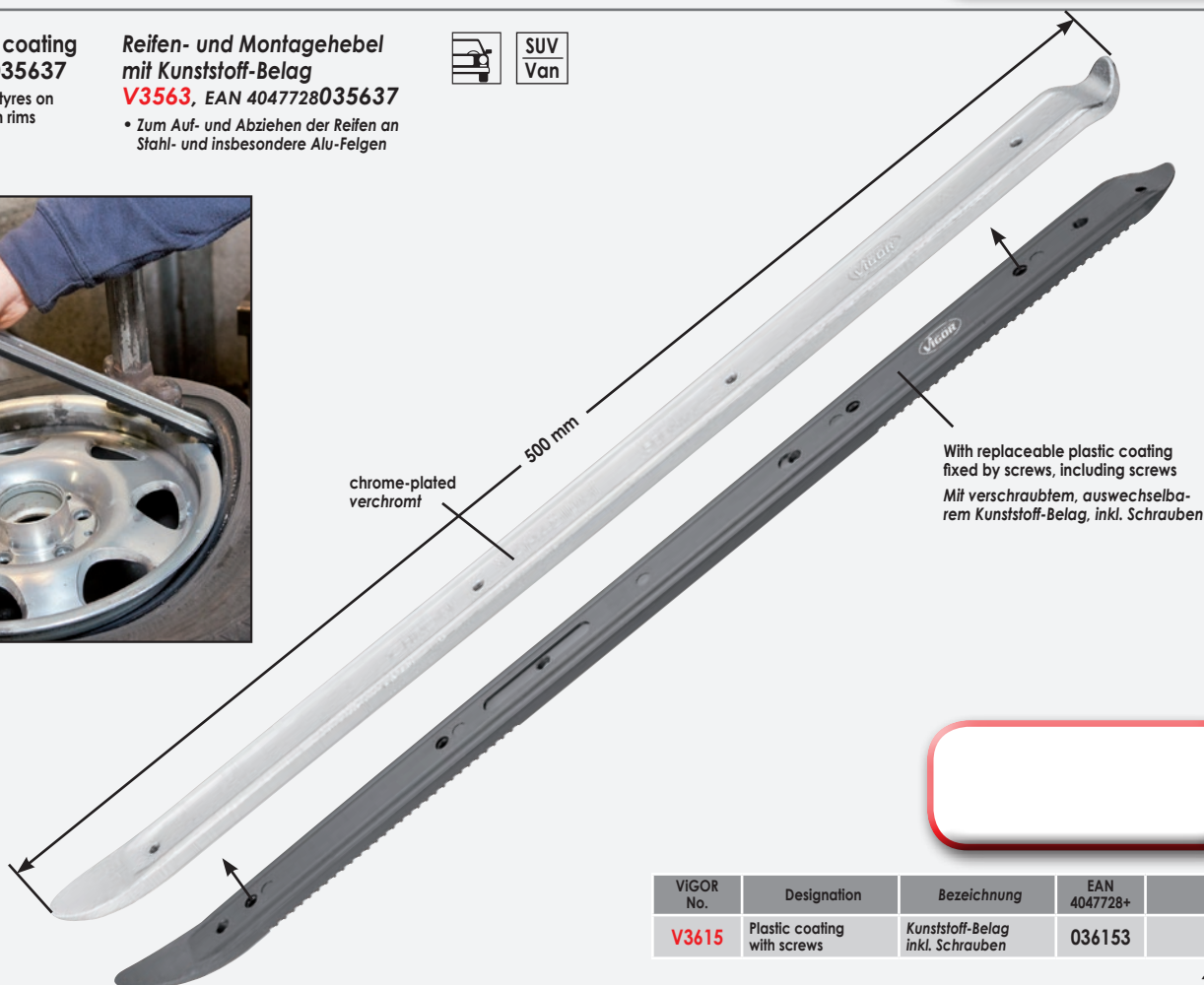

| VIGOR No. | Designation | Bezeichnung | EAN 4047728+ |
|--------------|-----------------------------|----------------------------------|---------------|
| V3615 | Plastic coating with screws | Kunststoff-Belag inkl. Schrauben | 036153 |

Balance weight remover set
V2512, EAN 4047728025126



- Solvent resistant
- Blunt edges may be sharpened with a file
- No damage to surfaces
- Ideal for removing balance weights from light-alloy rims on motorcycles and passenger cars
- Also suitable for removing labels and stickers

Klebegewicht-Entferner-Satz
V2512, EAN 4047728025126

- Lösemittelbeständig
- Mittels Feile nachschleifbar
- Oberflächen werden nicht beschädigt
- Ideal zur Demontage von Klebegehalten auf Alufelgen bei Pkw und Motorrad
- Auch zum Ablösen von Etiketten, Klebe- und Typenschildern



| VIGOR No. | Width mm Breite mm | EAN 4047728+ |
|-----------|-----------------------|--------------|
| V2513 | 19 | 025133 |
| V2514 | 22 | 025140 |
| V2515 | 25 | 025157 |
| V2516 | 38 | 025164 |



Balance weight remover
V2514, EAN 4047728025140

Klebegewicht-Entferner
V2514, EAN 4047728025140



Top seller!
Topseller!

Balance weight pliers
V1657, EAN 4047728016575

Auswuchtgewicht-Zange
V1657, EAN 4047728016575



Tyre tread depth gauge

V1584, EAN 4047728015844

- Zero-setting possible in any position
- Suitable for detecting wear patterns on tyres, brake shoes and brake linings
- \square 3 V (CR 2032) – 240 mAh

Profiltiefenmesser

V1584, EAN 4047728015844

- Nullstellung in jeder Position möglich
- Verwendbar zur Messung von Profiltiefen, Bremsklötzen und Bremsbelägen
- \square 3 V (CR 2032) – 240 mAh

max. 27 mm \rightarrow



Tyre pressure gauge

V1423, EAN 4047728014236

- Measuring ranges:
- 0,15–7 bar
- 2–99,5 PSI
- 15–70 KPA
- \square 3 V (CR 2032) – 240 mAh

Reifendrucktester

V1423, EAN 4047728014236

- Messbereiche:
- 0,15–7 bar
- 2–99,5 PSI
- 15–70 KPA
- \square 3 V (CR 2032) – 240 mAh



Special twist sockets

V1378, EAN 4047728013789

- Special profile for loosening aluminium rim locks, unscrewing tight wheel nuts and bolts with damaged heads
- Sockets usable on both sides:
- 1. As normal socket /
- 2. As special cutting thread
- Set consisting of:
- \square $\frac{1}{2}$ size 17 mm
- \square $\frac{1}{2}$ size 19 mm
- \square $\frac{1}{2}$ extension 60 mm



Spezial-Ausdreh-Steckschlüssel-Einsätze

V1378, EAN 4047728013789

- Spezialprofil zum Lösen von Felgenschlössern, feststehenden Radbolzen und Muttern mit rundgedrehten Köpfen
- Steckschlüssel-Einsätze zweiseitig verwendbar:
- 1. Als normaler Steckschlüsseleinsatz /
- 2. Als Spezial-Schneidgewinde
- Satz bestehend aus:
- \square $\frac{1}{2}$ SW 17 mm
- \square $\frac{1}{2}$ SW 19 mm
- \square Verlängerung 60 mm



12⁵/₁₆" Impact socket set
V2257, EAN 4047728022576

12⁵/₁₆"



12⁵/₁₆" Schlagschrauber-Steckschlüssel-Satz
V2257, EAN 4047728022576

| VIGOR No. | Sizes (mm) SW (mm) | mm | EAN 4047728+ |
|-----------|--------------------|----|--------------|
| V2471 | 15 | 85 | 024716 |
| V2472 | 17 | 85 | 024723 |
| V2473 | 19 | 85 | 024730 |
| V2474 | 21 | 85 | 024747 |
| V2475 | 22 | 85 | 024754 |



Incl. plastic sleeve
Inkl. Kunststoffhülse

Impact wrenches
see page p. 114
Schlagschrauber
siehe S. 114



12⁵/₁₆" Impact socket set
V2522, EAN 4047728025225

12⁵/₁₆"



12⁵/₁₆" Schlagschrauber-Steckschlüssel-Satz
V2522, EAN 4047728025225

| VIGOR No. | Sizes (mm) SW (mm) | mm | EAN 4047728+ |
|-----------|--------------------|----|--------------|
| V2472 | 17 | 85 | 024723 |
| V2473 | 19 | 85 | 024730 |
| V2474 | 21 | 85 | 024747 |



Incl. plastic sleeve
Inkl. Kunststoffhülse

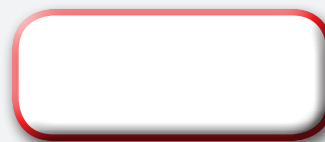

2.5 kg rubber hammer
V2235, EAN 4047728022354

- Especially for loosening rusted rims during a tyre change

Gummihammer 2,5 kg
V2235, EAN 4047728022354

- Speziell zum Lösen festgerosteter Felgen beim Reifenwechsel



5 kg rubber hammer
V2234, EAN 4047728022347

- Extra heavy design, especially suitable for commercial vehicles
- Especially for loosening rusted rims during a tyre change

Gummihammer 5 kg
V2234, EAN 4047728022347

- Extra schwere Ausführung, besonders geeignet für Nfz
- Speziell zum Lösen festgerosteter Felgen beim Reifenwechsel



Steering wheel level
V1571, EAN 4047728015714



Lenkrad-Einstellwaage
V1571, EAN 4047728015714

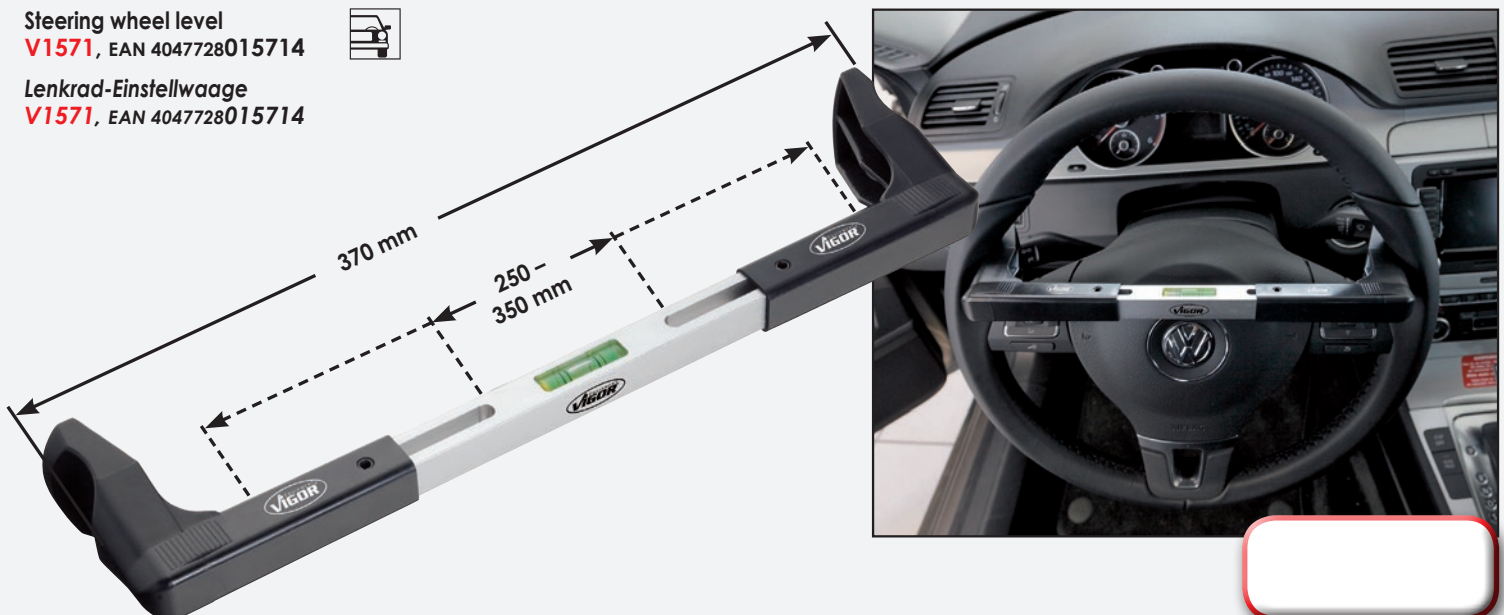

Steering tie rod joint tool

- For fast and professional replacement of axial joints on steering tie rods on passenger cars and small commercial vehicles
- Easy installation of longer steering tie rods due to open construction

Spurstangen-Gelenk-Werkzeug

- Zum fachgerechten und schnellen Austausch von Spurstangen-Axialgelenken an Pkw und leichten Nfz
- Problemlose Montage längerer Spurstangen durch offene Bauweise

Size 27 mm
SW 27 mm

12.5 1/2"

V2684, EAN 4047728026840

For steering tie rod ends 28–35 mm Ø



V2684, EAN 4047728026840

Für Spurstangenköpfe 28–35 mm Ø

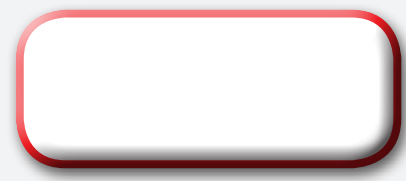

Size 27 mm
SW 27 mm

12.5 1/2"

V2683, EAN 4047728026833

For steering tie rod ends 35–45 mm Ø



V2683, EAN 4047728026833

• Für Spurstangenköpfe 35–45 mm Ø





Motor Vehicle - Chassis Ball Joint / Shock Absorber Hfa-Fahrwerk - Kugelgelenk / Stoßdämpfer



Shock absorber assembly tool set V3863, EAN 4047728038638

- Suitable for installation and removal of shock absorbers with rebound spring
- Special construction enables appropriate lifting of the piston rod without tilting
- Clamping piece with V-formed plastic inserts enables fixation in final stop position without causing any damage
- For: BMW, FIAT, FORD, MERCEDES-BENZ, NISSAN, PEUGEOT, TOYOTA
- Contents:
Special base component
Sturdy threaded spindle M12 with special receptacle
Universal clamping piece with V-formed plastic inserts

Stoßdämpfer-Montagewerkzeug-Satz V3863, EAN 4047728038638

- Zur Demontage und Montage an Stoßdämpfern mit Zuganschlagfeder
- Spezielle Konstruktion ermöglicht fachgerechtes Hochziehen der Kolbenstange ohne Verkranten
- Fixierung mittels Klemmstücke mit V-Form Kunststoffeinsätzen in Endanschlagposition ohne Beschädigung
- Für: BMW, FIAT, FORD, MERCEDES-BENZ, NISSAN, PEUGOT, TOYOTA
- Inhalt:
Spezial-Grundkörper
Robuste M12 Gewindespindel mit Spezialaufnahme
Universal-Klemmstück mit V-Form-Kunststoffeinsätzen

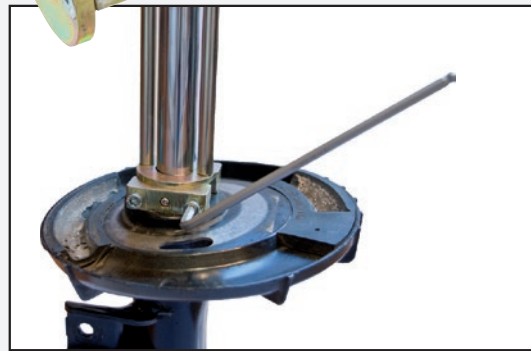
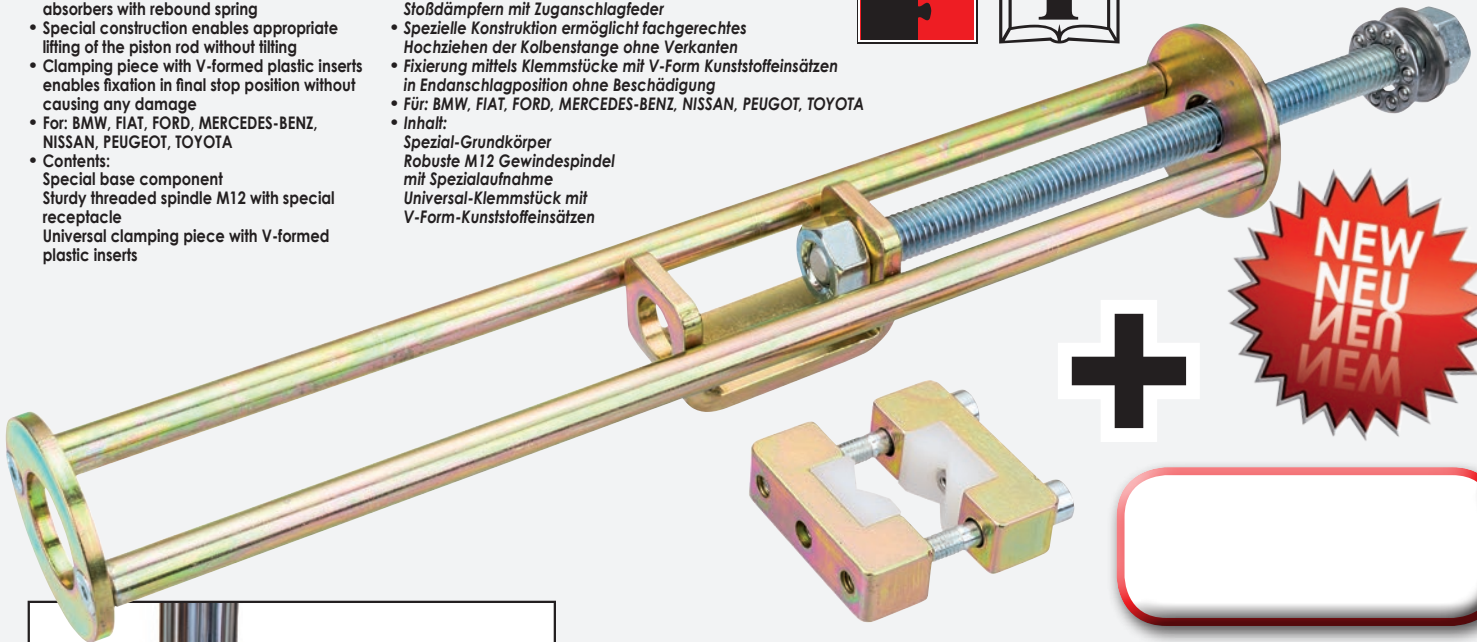

Universal clamping piece
with plastic protective jaws
Universal-Klemmstück
mit Kunststoff-Schonbacken
V3661, EAN 4047728036610

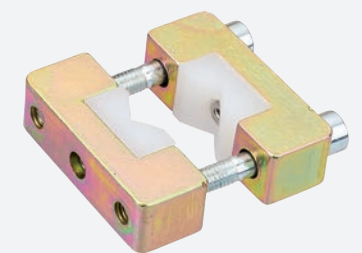
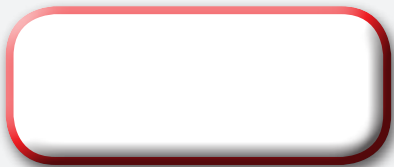

Ball joint puller, hydraulic V3308, EAN 4047728033084

- For removing the ball joint pivots of steering tie rods, stabilizers, etc. on the most common vehicles

Kugelgelenk-Abzieher, hydraulisch V3308, EAN 4047728033084

- Zum Abdrückenn der Kugelgelenkzapfen an Spurstangen, Stabilisatoren usw. für die gängigsten Fahrzeugmarken



Hydraulic spindle,
capacity: 8 tons
Hydraulikspindel,
Kraft: 8 t

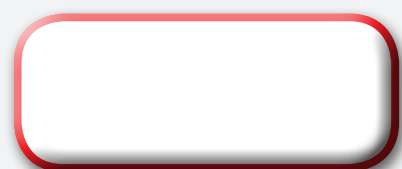

Guide bolts repair set V4127, EAN 4047728041270

- Fast and inexpensive repair of the inside thread (M9 x 1.25 mm) on the wheel bearing housing / calliper anchor bracket
- Use of threaded sleeves or similar repairs are not needed, no new brake guide bolts need to be purchased
- Extend the available thread to M10 x 1.25 mm and screw in guide bolts provided
- Suitable for the following vehicles:
 - VW Sharan, Touareg, Phaeton, transporter Synchro, transporter 1999-2010
 - SEAT Alhambra
 - AUDI A6, A8 (also Quattro)

Führungsbolzen-Reparatur-Satz V4127, EAN 4047728041270

- Schnelle und kostengünstige Reparatur des Innengewindes (M9 x 1,25 mm) am Radlagergehäuse / Bremsattelträger
- Einsatz von Gewindehülsen oder ähnlichen Reparaturen entfällt, es muss kein neuer Bremsführungsbolzen gekauft werden
- Erweitern des vorhandenen Gewindes auf M10 x 1,25 mm und mitgelieferten Führungsbolzen eindrehen
- Geeignet für folgende Fahrzeuge:
 - VW Sharan, Touareg, Phaeton, Transporter Synchro, Transporter 1999-2010
 - SEAT Alhambra
 - AUDI A6, A8 (auch Quattro)



| VIGOR No. | Designation | Bezeichnung | EAN 4047728+ |
|-----------|------------------------------|--------------------------------|--------------|
| V4262 | Brake guide bolts M10 x 1.25 | Bremsführungsbolzen M10 x 1,25 | 042628 |



Clamping screw disassembly tool set for four-link axle VAG V4126, EAN 4047728041263

- Special tool for loosening the clamp screw on the four-link axle in VAG vehicles e.g. AUDI A4, A6 etc.
- Can also be used in aluminium axle knuckles
- Contents:
 - 3 high-performance drills (HSS cobalt), size: 6 8.5 10 mm
 - 1 pressure clamp
 - 1 ejector drift

Klemmschrauben-Demontage-Werkzeug-Satz für Vierlenker-Achse VAG V4126, EAN 4047728041263

- Spezialwerkzeug zum Lösen der Klemmschraube an der Vierlenkerachse bei VAG-Fahrzeugen, z. B. AUDI A4, A6 etc.
- Einsetzbar auch bei Aluminium-Achsschenkeln
- Inhalt:
 - 3 Hochleistungsbohrer (HSS Cobalt), Größe: 6 8,5 10 mm
 - 1 Andrückbügel
 - 1 Ausschlag-Werkzeug



| No. Nr. | VIGOR No. | Designation | Bezeichnung | EAN 4047728+ |
|---------|-----------|------------------|-------------------|--------------|
| ① | V4248 | HSS drill 6 mm | HSS-Bohrer 6 mm | 042482 |
| ② | V4249 | HSS drill 8,5 mm | HSS-Bohrer 8,5 mm | 042499 |
| ③ | V4250 | HSS drill 10 mm | HSS-Bohrer 10 mm | 042505 |



Tensioning ratchet

V2236, EAN 4047728022361

- For easy installation of clips and hose clamps (free-end), as well as prefabricated clamps
- For clips 6 mm to 10 mm wide



Spannratsche

V2236, EAN 4047728022361

- Zur einfachen Montage für Band- und Schlaufen- (Free-end) Schellen oder auch vorgefertigten Schellen
- Für Bandschellen mit einer Breite von 6–10 mm

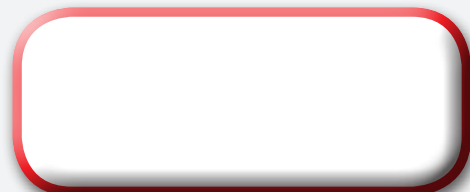

Metal tightening strap set

V2391, EAN 4047728023917

- 20 pieces / set
- To be used with tensioning ratchet V2236



Metall-Spannband-Satz

V2391, EAN 4047728023917

- 20 Stück / Satz
- In Verbindung mit Spannratsche V2236

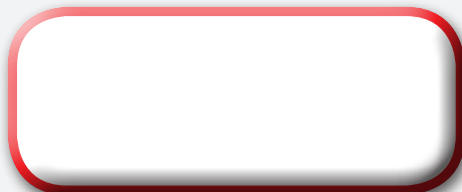
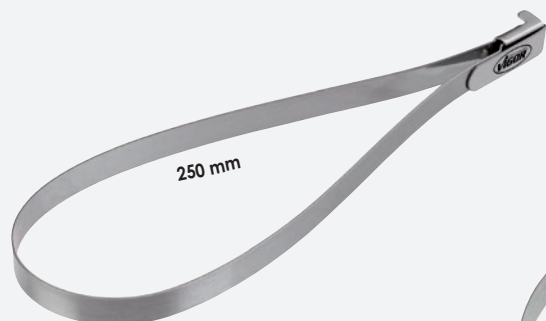

Metal tightening strap set

V2392, EAN 4047728023924

- 20 pieces / set
- To be used with tensioning ratchet V2236



Metall-Spannband-Satz

V2392, EAN 4047728023924

- 20 Stück / Satz
- In Verbindung mit Spannratsche V2236

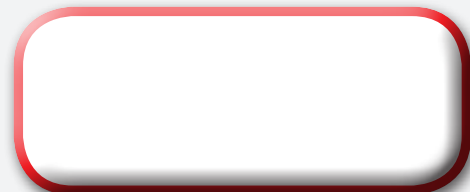

Induction heater with function for plastic repairs

V3813, EAN 4047728038133

- For the quick and exact heating of rusted or hard to loosen nuts and bolts or micro-encapsulated connections
- Including 5 heating coils and 6 types of clamp (100 pieces of each) for repairing plastic

Induktionsheizgerät mit Kunststoffreparatur-Funktion

V3813, EAN 4047728038133

- Zur schnellen und punktgenauen Erhitzung von festgerosteten bzw. schwer lösbaren Schrauben und Muttern oder mikroverkapselten Verbindungen
- Inkl. 5 Heizspulen und 6 Klammertypen (je 100 Stück) zur Kunststoffreparatur



Induction application / Induktions-Anwendung

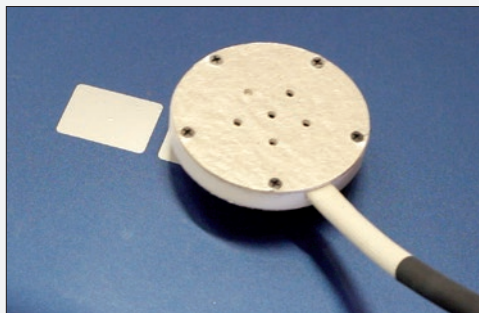

Contents: / Im Satz enthalten:

**Induction accessories
Induktions-Zubehör**



**Accessories for synthetic repairs
Zubehör für die Kunststoffreparatur**

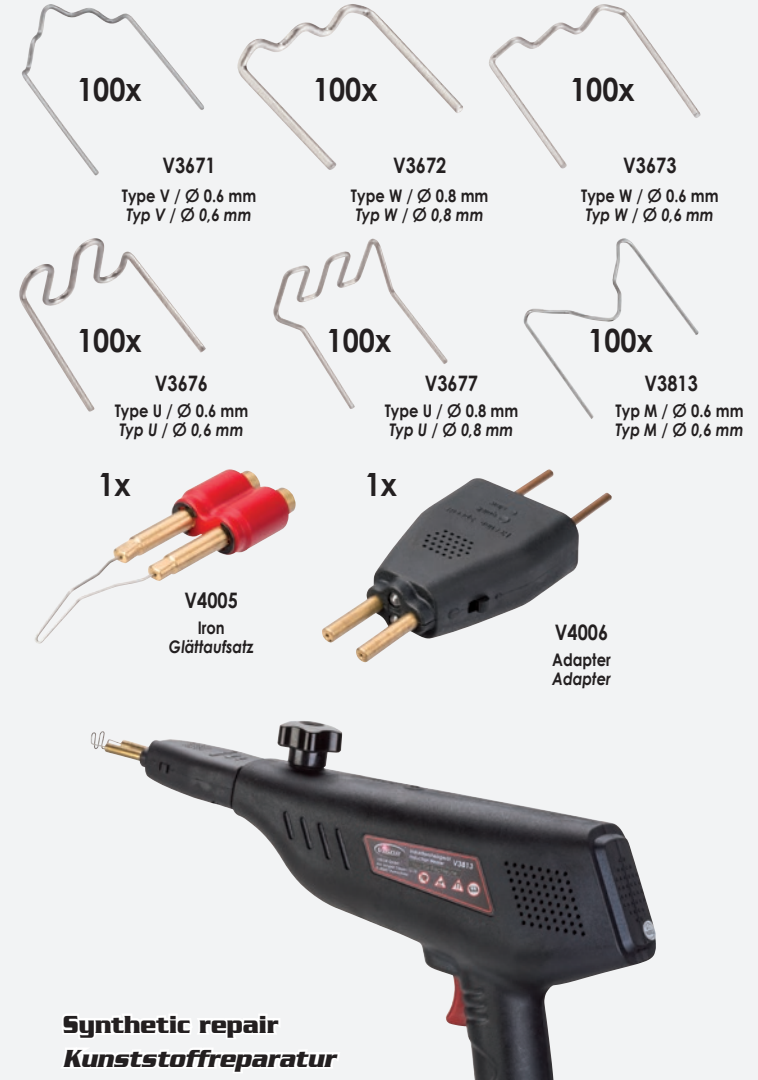

**Induction function
Induktionsfunktion**

| VIGOR No. | X | Designation | Bezeichnung | EAN 4047728+ |
|-----------|---|------------------------------|-------------------------------|--------------|
| V4005 | 1 | Moulding iron | Modellereinsatz | 040051 |
| V4006 | 1 | Adapter | Adapter | 040068 |
| V4007 | 1 | Induction loop | Runder Induktionsstrahler | 040075 |
| V4008 | 3 | Induction coil set, U-shaped | U-Induktionsspulen-Set | 040082 |
| V4009 | 3 | Flexible induction coil set | Flexible Induktionsspulen-Set | 040099 |
| V4010 | 3 | Induction coil set 32 mm | Induktionsspulen-Set 32 mm | 040105 |
| V4121 | 3 | Induction coil set 19 mm | Induktionsspulen-Set 19 mm | 041218 |

**Synthetic repair
Kunststoffreparatur**

| VIGOR No. | X | Designation | Bezeichnung | EAN 4047728+ |
|-----------|-----|-------------------------|---------------------------|--------------|
| V3671 | 100 | Staples, V-shape 0.6 mm | Klammern, V-Format 0,6 mm | 036719 |
| V3672 | 100 | Staples, W-shape 0.8 mm | Klammern, W-Format 0,8 mm | 036726 |
| V3673 | 100 | Staples, W-shape 0.6 mm | Klammern, W-Format 0,6 mm | 036733 |
| V3674 | 100 | Staples, F-shape 0.8 mm | Klammern, F-Format 0,8 mm | 036740 |
| V3675 | 100 | Staples, S-shape 0.8 mm | Klammern, S-Format 0,8 mm | 036757 |
| V3676 | 100 | Staples, U-shape 0.6 mm | Klammern, U-Format 0,6 mm | 036764 |
| V3677 | 100 | Staples, U-shape 0.8 mm | Klammern, U-Format 0,8 mm | 036771 |

Synthetic repair / Kunststoffreparatur

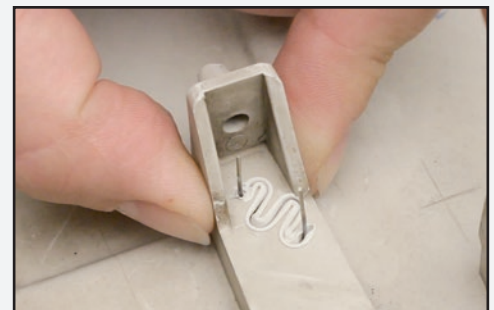

Repair set for plastic parts

V3551, EAN 4047728035514

- For the repair and reinforcement of plastic parts, such as cracked light bars and housing parts
- Suitable for repairing plastic components within a few minutes, the kit ensures dimensional stability and prepares the work-piece for subsequent treatments such as painting or filling.
- Electrical output: 100-240 V -50/60Hz
- Max: up to 20W
- Contents: 100 clips type V / Ø 0.6 mm
100 clips type W / Ø 0.6 mm
100 clips type W / Ø 0.8 mm



Kunststoff-Reparatur-Satz

V3551, EAN 4047728035514

- Zur Reparatur und Verstärkung von Kunststoffteilen wie z.B. gerissene Lampenbügel und Gehäuseteile
- In wenigen Minuten ist ein Bauteil formstabil repariert und für eine mögliche Weiterverarbeitung wie z. B. Lackierung oder Spachteln vorbereitet.
- Elektrische Leistung: 100-240 V - 50 / 60 Hz
- Max: Bis zu 20 W
- Inhalt: 100 Klammern Typ V / Ø 0,6 mm
100 Klammern Typ W / Ø 0,6 mm
100 Klammern Typ W / Ø 0,8 mm



Included in the set: / Im Satz enthalten:

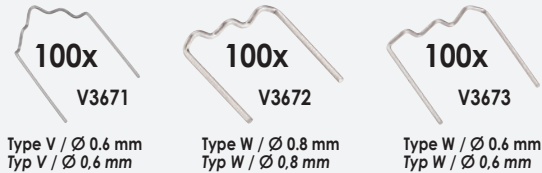

Also available: / Zusätzlich erhältlich:

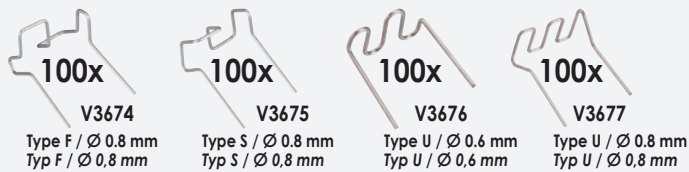

| VIGOR No. | X | Designation | Bezeichnung | EAN 4047728+ |
|-----------|-----|-------------------------|---------------------------|--------------|
| V3671 | 100 | Staples, V-shape 0.6 mm | Klammern, V-Format 0,6 mm | 036719 |
| V3672 | 100 | Staples, W-shape 0.8 mm | Klammern, W-Format 0,8 mm | 036726 |
| V3673 | 100 | Staples, W-shape 0.6 mm | Klammern, W-Format 0,6 mm | 036733 |
| V3674 | 100 | Staples, F-shape 0.8 mm | Klammern, F-Format 0,8 mm | 036740 |
| V3675 | 100 | Staples, S-shape 0.8 mm | Klammern, S-Format 0,8 mm | 036757 |
| V3676 | 100 | Staples, U-shape 0.6 mm | Klammern, U-Format 0,6 mm | 036764 |
| V3677 | 100 | Staples, U-shape 0.8 mm | Klammern, U-Format 0,8 mm | 036771 |

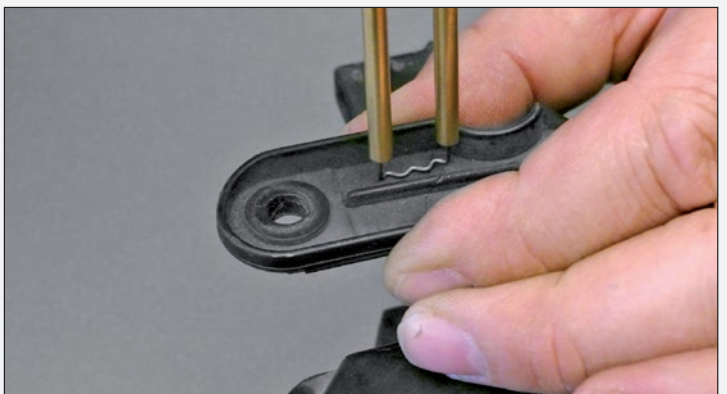
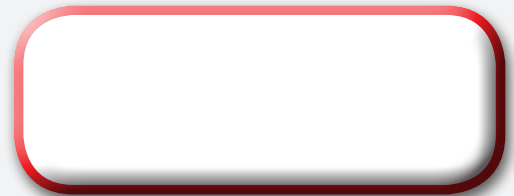

Wiper arm extractor set
V2523, EAN 4047728025232

- Universally usable
- Allows easy disassembly of all common wiper arms
- Optimum usability options with rusted and stuck wiper arms
- Best possible protection for integrated wiper nozzles when used with a sliding hammer

Scheibenwischerarm-Abzieher-Satz
V2523, EAN 4047728025232

- Universell verwendbar
- Ermöglicht einen problemlosen Ausbau aller gängigen Wischerarme
- Optimale Einsatzmöglichkeiten bei gerosteten und feststehenden Wischerarmen
- Größtmöglicher Schutz für integrierte Wischerdüsen bei Anwendung mit Schlagauszieher



①



②



③

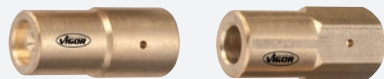

④



⑤



⑥



⑦



⑧



⑨



⑩



⑪



⑫



⑬



| No. Nr. | VIGOR No. | Designation | Bezeichnung | EAN 4047728+ |
|---------|-----------|--------------------|---------------------|--------------|
| ① | V4153 | Universal puller | Universalsabzieher | 041539 |
| ② | V4154 | Sliding hammer | Schlagauszieher | 041546 |
| ③ | V4155 | Pressure spindle | Druckspindel | 041553 |
| ④ | V4156 | Spindle extension | Spindelverlängerung | 041560 |
| ⑤ | V4157 | Spindle attachment | Spindelvorsatz | 041577 |
| ⑥ | V4159 | Gripper 1 | Zugglocke 1 | 041591 |
| ⑦ | V4160 | Gripper 2 | Zugglocke 2 | 041607 |
| ⑧ | V4161 | Gripper 3 | Zugglocke 3 | 041614 |
| ⑨ | V4162 | Gripper 4 | Zugglocke 4 | 041621 |
| ⑩ | V4163 | Gripper 5 | Zugglocke 5 | 041638 |
| ⑪ | V4164 | Gripper 6 | Zugglocke 6 | 041645 |
| ⑫ | V4165 | Gripper 7 | Zugglocke 7 | 041652 |
| ⑬ | V4158 | Gripper 8 | Zugglocke 8 | 041584 |

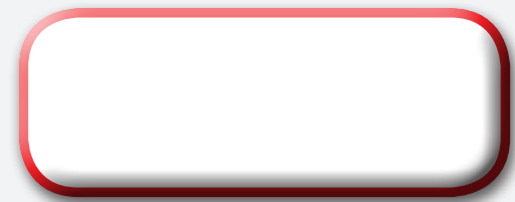

Window pane holders

V2685, EAN 4047728026857

Saugheber

V2685, EAN 4047728026857



Spreading pad

V1784, EAN 4047728017848

- For universal use e.g. door opening, positioning, fixing and pushing away car body parts, inner linings etc.

Türöffner-Spreizkissen

V1784, EAN 4047728017848

- Universell einsetzbar zum Positionieren, Fixieren und Abdrücken von Karosserieteilen, Innenverkleidungen etc.

