



2

vehicle service tools

including a new range of timing tools

76-83 timing tools
84-93 diagnostics
94-96 automotive specialised socketry
97-105 engine and transmission
106-107 cooling
108-110 steering and suspension

111-117 brakes
118-122 tyres and wheels
123-127 bodywork and windscreen
128 motorcycle tools
129-132 breakdown and recovery
133-141 consumables and accessories

TIMING TOOLS

NEW RANGE

A brand new range of Timing and Locking Tools, ideal for the professional automotive technician.

Pages **76-83**



DIAGNOSTICS

All modern vehicles have a host of systems that can and sometimes do go wrong, despite what manufacturers tell us!

The products in our range will help to diagnose problems.

Pages **84-93**



SPECIALISED AUTO SOCKETRY



Check out this extended selection of automotive specific sockets and socket sets. All fully guaranteed.

Pages **94-96**

ENGINE & TRANSMISSION



Almost ten whole pages of high quality engine and transmission tools.

Pages **97-105**

COOLING

These items will enable you to service cooling systems on most modern vehicles.

Pages **106-107**



STEERING & SUSPENSION

A professional selection of quality tools for general servicing of automotive steering and suspension.

Pages **108-110**



BRAKES



A variety of the most common tools required for brake servicing on a host of major car makes and models.

Pages **111-117**

TYRES & WHEELS



Ideal products for tyres and wheels, from the professional technician to the DIY user - they're all here!

Pages **118-122**

BODYWORK & WINDSCREEN

If you need tools for your bodyshop or just general repair work, look no further than this section.

Pages **123-127**



MOTORCYCLE TOOLS

A range of popular tools for working on motorcycles.

Please see Section 3, Workshop Equipment for motorcycle lifts.

Pages **128**



BREAKDOWN & RECOVERY



A quality range of breakdown and recovery tools.

Pages **129-132**

CONSUMABLES & ACCESSORIES



Thread Lock, Fuses, Latex Gloves, Dashboard Renovator, Chamois Leathers - an impressive selection for many automotive applications.

Pages **133-141**

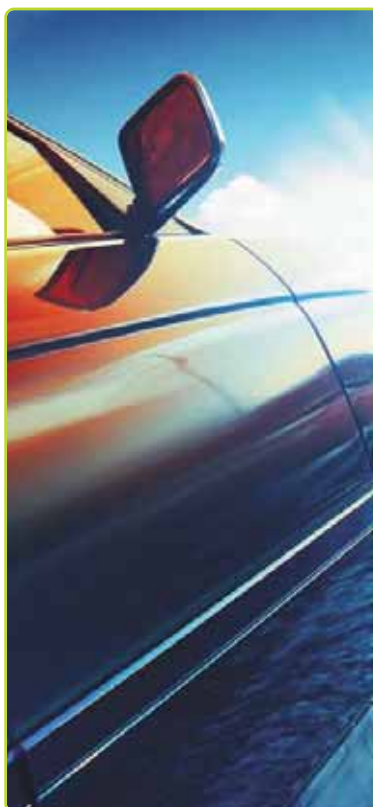

NEW RANGE

timing & locking tool range

To ensure you can find the right kit, we've developed a fast and effective web-based search engine for you:



STEP 1:

Select the vehicle manufacturer i.e. Alfa Romeo, Ford, Peugeot, Vauxhall etc.



STEP 2:

Select the fuel type - petrol or diesel...

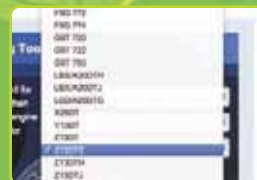

STEP 3:

Select the engine code...

www.drapertools.com/timingtools

DRAPER Expert



1 ETK1

BMW Timing Kit (Full Service Kit)

BMW Engine Codes: 22 6S 1, 20 6S 4, 25 6S 4, 28 6S 2

Always refer to the vehicle manufacturer for the correct use of this kit

| Stock No. | Box Qty | Price per kit |
|-----------|---------|---------------|
| 32733 | - | €249.98D |

DRAPER Expert



3 ETK3

BMW/Vauxhall Timing Kit

BMW Engine Codes: 20 4D 1, 17 4T 1, 25 6T 1

Vauxhall Engine Codes: 25DT, X25DT

Always refer to the vehicle manufacturer for the correct use of this kit

| Stock No. | Box Qty | Price per kit |
|-----------|---------|---------------|
| 32735 | - | €174.98D |

DRAPER Expert

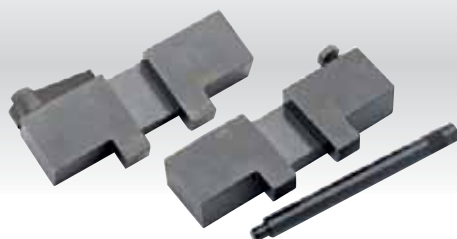

2 ETK2

BMW Timing Kit (Chain-Only)

BMW Engine Codes: 22 6S 1, 20 6S 4, 25 6S 4, 28 6S 2

Always refer to the vehicle manufacturer for the correct use of this kit

| Stock No. | Box Qty | Price per kit |
|-----------|---------|---------------|
| 32734 | - | €124.98D |

DRAPER Expert

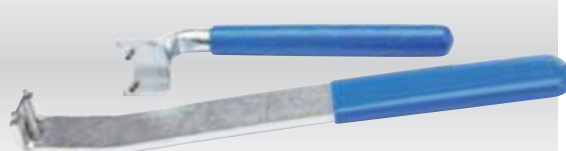

4 ETK4

VAG Tension Kit

VAG Engine Codes:

AUA, BAD, AFK, AHW, APE, AQQ, AUB, AUS, AXP, AZD, BBY, BBZ, BCA, BCB, BKY, AUA, AUB, AXP, BBY, BBZ, BCA, BKY, BUD, CGGA, AFK, AJV, AKQ, APE, AQQ, ARC, ARR, ATN, AVY

Always refer to the vehicle manufacturer for the correct use of this kit

| Stock No. | Box Qty | Price per kit |
|-----------|---------|---------------|
| 32736 | - | €55.63D |

DRAPER Expert



1 ETK5

VAG Timing Kit (Diesel Only)

VAG Engine Codes:

1Y, AFGR, AFN, AHP, ALH, ASV, AZZ, AAZ, AEF, AFN, AGP, AGR, AHF, AHU, AKW, ALH, AQM, ASV, AYQ, AEF, AGP, AGR, AHF, ALH, AQM, ASV, AAZ, ABL, AEF, AEF, AFN, AGD, AGP, AGR, AHB, AHF, AHG, AHU, AKU, AKW, ALE, ALH, AQM, ASV, ASX, AYQ

Always refer to the vehicle manufacturer for the correct use of this kit

| Stock No. | Box Qty | Price per kit |
|-----------|---------|---------------|
| 32737 | - | €70.63D |

DRAPER Expert



4 ETK8

Ford/Jaguar/Land Rover Tensioning Kit

Ford Engine Codes:

ABFA, D3FA, F3FA, D5BA, D6BA, FMBA, FMBB, HJBC, N7BA, F1FA, F4FA, D2FA, D4FA, D0FA, FXFA, H9FB, JXFA, QJBA, QJBB

Jaguar Engine Codes: FMBA, FMBB, QJBA

Land Rover Engine Codes: 244DT

Always refer to the vehicle manufacturer for the correct use of this kit

| Stock No. | Box Qty | Price per kit |
|-----------|---------|---------------|
| 32744 | - | €24.98D |

DRAPER Expert

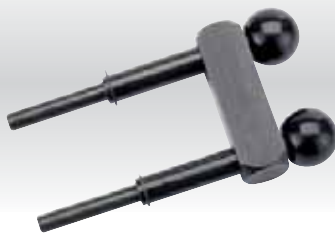

2 ETK6

VAG Timing Kit

VAG Engine Codes:

AFK, AHW, AKQ, AJV, AQQ, APE, ARC, ARR, ATN, AUA, AUB, AUS, AVY, AXP, AZD, BBY, BBZ, BCA, BCB, BKY, BUD

Always refer to the vehicle manufacturer for the correct use of this kit

| Stock No. | Box Qty | Price per kit |
|-----------|---------|---------------|
| 32741 | - | €43.70D |

DRAPER Expert



5 ETK9

VAG/Ford Timing Kit

VAG Engine Codes:

AJM, AMF, ANU, ANY, ARL, ASZ, ATD, AUY, AXR, AYZ, AGD, AHG, AKU, ASX, AEF, AFN, AHB, AHU, AKW, ALE, AEF, 1Y

Ford Engine Codes: AFN, ANU, AUY, ASZ

Always refer to the vehicle manufacturer for the correct use of this kit

| Stock No. | Box Qty | Price per kit |
|-----------|---------|---------------|
| 32745 | - | €64.88D |

DRAPER Expert

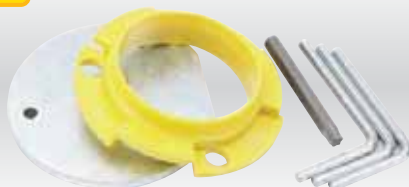

3 ETK7

Ford/Jaguar/Land Rover Timing Kit

Ford Engine Codes:

ABFA, D3FA, F3FA, D5BA, D6BA, FMBA, FMBB, HJBC, N7BA, F1FA, F4FA, D2FA, D4FA, D0FA, FXFA, H9FB, JXFA, QJBA, QJBB

Jaguar Engine Codes: FMBA, FMBB, QJBA

Land Rover Engine Codes: 244DT

Always refer to the vehicle manufacturer for the correct use of this kit

| Stock No. | Box Qty | Price per kit |
|-----------|---------|---------------|
| 32742 | - | €112.48D |

DRAPER Expert



6 ETK10

Ford Timing Kit

Ford Engine Codes: RFK, RFN, RTJ, RTK, RVA

Always refer to the vehicle manufacturer for the correct use of this kit

| Stock No. | Box Qty | Price per kit |
|-----------|---------|---------------|
| 32747 | - | €26.88D |

NEW

timing & locking tool range

Scan the QR code on the right to visit the website...

www.drapertools.com/timingtools



BOX QUANTITY INFORMATION

FOR YOUR CONVENIENCE, WE RECOMMEND ORDERING IN BOX QUANTITY OR MULTIPLES OF BOX QUANTITY WHERE SHOWN. YOU CAN STILL ORDER IN ANY QUANTITY UNLESS SPECIFICALLY STATED OTHERWISE



NEW RANGE

timing & locking tool range



1 ETK11

Ford Timing Kit

Ford Engine Codes: HXDA, SIDA

Always refer to the vehicle manufacturer for the correct use of this kit

DRAPER Expert

| Stock No. | Box Qty | Price per kit |
|-----------|---------|---------------|
| 32748 | - | €62.48D |

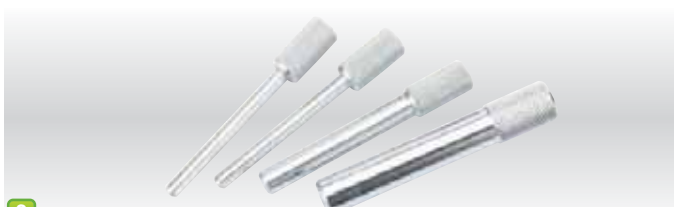

2 ETK12

Ford/PSA Timing Kit

Ford Engine Codes:

F6JA, F6JB, F6JC, F6JD, HHJA, HHJB, HHJC, HHJD, HHJE, HHJF, G8DA, G8DB, G8DD, GPDA, HHDA

PSA/Citroën Engine Codes: DV4TD, 8HT, 8HV, 8HW, 8HX, 8HZ

Always refer to the vehicle manufacturer for the correct use of this kit

DRAPER Expert

| Stock No. | Box Qty | Price per kit |
|-----------|---------|---------------|
| 32750 | - | €24.98D |



3 ETK13

Renault/Vauxhall Timing Kit

Renault Engine Codes:

G9T 710, G9T 720, G9T 722, G9T 742, G9T 743, G9T 750, G9U 632, G9U 650, G9U 720, G9U 724, G9U 726, G9U 750, G9U 754

Vauxhall Engine Codes: G9T 720, G9T 722, G9T 750

Always refer to the vehicle manufacturer for the correct use of this kit

DRAPER Expert

| Stock No. | Box Qty | Price per kit |
|-----------|---------|---------------|
| 32752 | - | €121.88D |

PRODUCT INFORMATION

Our range of specialised service repair kits are precise tools, for this reason we advise that the user refers to the vehicle manufacturer's or relevant Haynes manual for the correct use.



4 ETK14

Renault/Vauxhall Tensioning Kit

DRAPER Expert

Renault Engine Codes:

F8Q 600, F8Q 610, F8Q 620, F8Q 622, F8Q 624, F8Q 630, F8Q 632, F8Q 644, F8Q 648, F8Q 646, F8Q 680, F8Q 662, F8Q 672, F8Q 692, F8Q 676, F8Q 696, F8Q 678, F8Q 706, F8Q 710, F8Q 714, F8Q 714, F8Q 730, F8Q 722, F8Q 724, F8Q 730, F8Q 732, F8Q 740, F8Q 742, F8Q 744, F8Q 764, F9Q 650, F9Q 660, F9Q 664, F9Q 670, F9Q 674, F9Q 680, F9Q 690, F9Q 710, F9Q 716, F9Q 717, F9Q 718, F9Q 720, F9Q 722, F9Q 730, F9Q 734, F9Q 731, F9Q 732, F9Q 733, F9Q 736, F9Q 740, F9Q 744, F9Q 746, F9Q 748, F9Q 750, F9Q 751, F9Q 752, F9Q 754, F9Q 755, F9Q 757

Vauxhall Engine Codes: F9Q 760, F9Q 772, F9Q 774

Always refer to the vehicle manufacturer for the correct use of this kit

| Stock No. | Box Qty | Price per kit |
|-----------|---------|---------------|
| 32753 | - | €149.98D |



5 ETK15

Renault Timing Kit

DRAPER Expert

Renault Engine Codes:

D7F 702, D7F 703, D7F 704, D7F 706, D7F 708, D7F 710, D7F 720, D7F 722, D7F 726, D7F 744, D7F 746, D7F 764, D7F 766, D7F 800, D7F A730, D7F B700, D7F C701

Always refer to the vehicle manufacturer for the correct use of this kit

| Stock No. | Box Qty | Price per kit |
|-----------|---------|---------------|
| 32754 | - | €59.38D |



6 ETK16

Vauxhall/SAAB Timing Kit

DRAPER Expert

Vauxhall Engine Codes:

Z19DT, Z19DTH, Z19DTL, LBS/A20DTH, LBX/A20DTJ, LCD/200DTC

SAAB Engine Codes: Z19DTH, A19DTR, Z19DTR

Always refer to the vehicle manufacturer for the correct use of this kit

| Stock No. | Box Qty | Price per kit |
|-----------|---------|---------------|
| 32756 | - | €78.69D |



1 ETK17

Vauxhall/SAAB Timing Kit

Vauxhall Engine Codes:

X14XE, X16XEL, X16XE, X16SEJ, X18E1, Z14XE, Z16XE, Z16YNG, Z18XE, Z18XEL

SAAB Engine Codes: Z18XE

Always refer to the vehicle manufacturer for the correct use of this kit

DRAPER Expert

| Stock No. | Box Qty | Price per kit |
|-----------|---------|---------------|
| 32757 | - | €49.98D |



4 ETK20

PSA Timing Kit

Citroen Engine Codes:

DW8/L3(WJZ), WJZ(DW8/LW3), WJZ(DW8/L/W3)

Peugeot Engine Codes:

WJZ(DW8B), DW8/L3W3(WJZ), DW8/L/W3(WJZ), DW8B(WJZ)

Always refer to the vehicle manufacturer for the correct use of this kit

DRAPER Expert

| Stock No. | Box Qty | Price per kit |
|-----------|---------|---------------|
| 32773 | - | €77.50D |



2 ETK18

Vauxhall/Suzuki Timing Kit

Vauxhall Engine Codes: Z13DT, Z13DTH, Z13DTJ

Suzuki Engine Codes: Z13DT

Always refer to the vehicle manufacturer for the correct use of this kit

DRAPER Expert

| Stock No. | Box Qty | Price per kit |
|-----------|---------|---------------|
| 32759 | - | €86.19D |



5 ETK21

PSA Timing Kit

Citröen Engine Codes:

(TU3JP/L3), (TU3JP/L4), CDY, CDZ, HDY, HFX(TU1A), KDX, KDY, KFY (TU3A), KFY (TU3JP), KFW, KFX (TU3A), KFX, KFX (TU3JP), KFX (TU3JP/IFL4), KFX (TU3JP/L4), KFX (TU3JP+/L3), TU1AJPL4

Peugeot Engine Codes:

TU1, TU3, TU3JP (KFW), TU3JP (KFX), TU3JP (KFX), TU3JP/IFL4 (KFX), TU3JP/L3 (KFX), TU5, TU9

Always refer to the vehicle manufacturer for the correct use of this kit

DRAPER Expert

| Stock No. | Box Qty | Price per kit |
|-----------|---------|---------------|
| 32774 | - | €37.48D |



3 ETK19

PSA Timing Kit

Citröen Engine Codes:

DW10ATED/L3, DW10BTED/L3, RHX (DW10ATD), RHS (DW10ATD), RHZ (DW10ATD), RHY (DW10ATD), RHY (DW10TD)

Peugeot Engine Codes: DW10ATD (RHY), DW10TD (RHY)

Always refer to the vehicle manufacturer for the correct use of this kit

DRAPER Expert

| Stock No. | Box Qty | Price per kit |
|-----------|---------|---------------|
| 32760 | - | €86.19D |



6 ETK22

Renault/Vauxhall Timing Kit

Renault Engine Codes:

F8Q 606, F8Q 600, F8Q 610, F8Q 620, F8Q 622, F8Q 624, F8Q 630, F8Q 632, F8Q 644, F8Q 646, F8Q 648, F8Q 662, F8Q 672, F8Q 676, F8Q 678, F8Q 680, F8Q 692, F8Q 696, F8Q 706, F8Q 710, F8Q 714, F8Q 722, F8Q 724, F8Q 730, F8Q 732, F8Q 740, F8Q 742, F8Q 744, F8Q 764, F9Q 650, F9Q 660, F9Q 664, F9Q 670, F9Q 674, F9Q 680, F9Q 690, F9Q 710, F9Q 716, F9Q 717, F9Q 718, F9Q 720, F9Q 722, F9Q 730, F9Q 731, F9Q 732, F9Q 733, F9Q 734, F9Q 736, F9Q 740, F9Q 744, F9Q 746, F9Q 748, F9Q 750, F9Q 751, F9Q 752, F9Q 754, F9Q 755, F9Q 757, K9K 700, K9K 702, K9K 704, K9K 706, K9K 710, K9K 712, K9K 714, K9K 716, K9K 718, K9K 722, K9K 724, K9K 728, K9K 729, K9K 732, K9K 734, K9K 740, K9K 750, K9K 752, K9K 760, K9K 762, K9K 764, K9K 766, K9K 768, K9K 770, K9K 772, K9K 774

Vauxhall Engine Codes: F9Q 760, F9Q 772, F9Q 774

Always refer to the vehicle manufacturer for the correct use of this kit

DRAPER Expert

| Stock No. | Box Qty | Price per kit |
|-----------|---------|---------------|
| 32775 | - | €23.13D |

NEW

timing & locking tool range

Scan the QR code on the right to visit the website...

www.drapertools.com/timingtools



BOX QUANTITY INFORMATION

FOR YOUR CONVENIENCE, WE RECOMMEND ORDERING IN BOX QUANTITY OR MULTIPLES OF BOX QUANTITY WHERE SHOWN. YOU CAN STILL ORDER IN ANY QUANTITY UNLESS SPECIFICALLY STATED OTHERWISE

NEW

timing & locking tool range

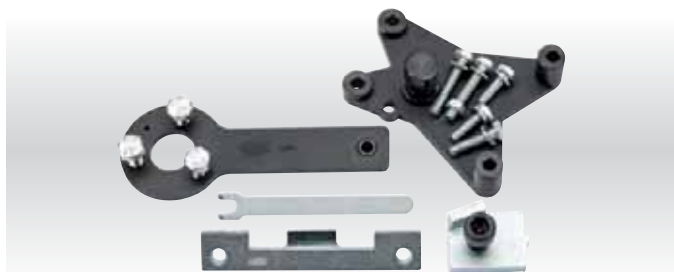

1 ETK23

DRAPER Expert

Fiat/Lancia/Ford Timing Kit

Fiat Engine Codes: 169A4.000, 199A4.000, 188A4.000 (EV02 ONLY)
Lancia Engine Codes: 169A4.000, 350A1.000 **Ford Engine Codes:** FP4
Always refer to the vehicle manufacturer for the correct use of this kit

| Stock No. | Box Qty | Price per kit |
|-----------|---------|---------------|
| 32801 | - | €174.98D |



2 ETK24

DRAPER Expert

Fiat/Lancia Timing Kit

Fiat Engine Codes: 176B9.000, 182B2.000, 188A5.000, 843A1.000, 169A3.000, 192B2.000, 198A1.000, 198A4.000, 199A6.000 **Lancia Engine Codes:** 176B9.000, 188A5.000, 843A1.000
Always refer to the vehicle manufacturer for the correct use of this kit

| Stock No. | Box Qty | Price per kit |
|-----------|---------|---------------|
| 32802 | - | €277.48D |



3 ETK25

DRAPER Expert

Fiat/Alfa Romeo/Lancia Timing Kit

Fiat Engine Codes: 198A2.000, 198A3.000, 198A6.000, 350A2.000, 182B4.000, 182B9.000, 186A6.000, 186A8.000, 186A9.000, 188A2.000, 188A7.000, 188B2.000, 192A1.000, 192A3.000, 192A8.000, 192A9.000, 192B4.000, 192B5.000, 199A5.000, 939A1.000, 939A5.000, 939A7.000, 223A7.000, 192A5.000, 937A5.000, 939A2.000, 939A8.000, 198A5.000, 185A6.000, 939A3.000
Alfa Romeo Engine Codes: 323.02, 371.01, 182B9.000, 937A2.000, 937A3.000, 939A1.000, 939A2.000, 939A7.000, 192A5.000, 192B1.000, 937A4.000, 937A5.000, 939A1.000, 939A2.000, 939A8.000, 325.01, 342.02, 362.02, 839A6.000, 841C.000, 841G.000, 841H.000, 841M.000, 939A3.000, 939A9.000
Lancia Engine Codes: 323.02, 371.01, 188B2.000, 937A2.000, 838A8.000, 839A5.000, 839A6.000, 841C.000, 841D.000, 841G.000, 841H.000
Always refer to the vehicle manufacturer for the correct use of this kit

| Stock No. | Box Qty | Price per kit |
|-----------|---------|---------------|
| 32803 | - | €171.23D |

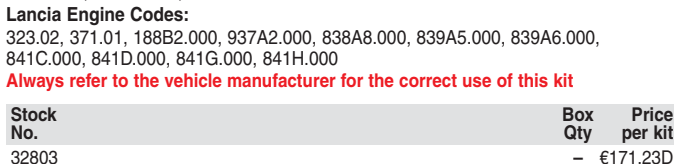

4 ETK26

DRAPER Expert

Fiat/Vauxhall/Lancia/Suzuki/Alfa Romeo/Ford Timing Kit

Fiat Engine Codes: 169A1.000, 199B1.000, 188A8.000, 169A5.000, 199A9.000, 188A9.000, 199B2.000, 199A2.000, 223A9.000, 199B4.000, 199A3.000, 263A2.000
Vauxhall Engine Codes: Z13DT, D13, Z13DTJ, D13A, A13DTC, A13DTE, A133DTR, Z13DTE, Z13DTH, Z13DTR, Y13DT, Z13DT
Lancia Engine Codes: 199A3.000, 188A9.000, 843A2.000, 199A2.000, 199B1.000
Suzuki Engine Codes: Z13DT, Z13DTJ, D13A199A3.000, 199B1.000
Alfa Romeo Engine Codes: 199A3.000, 199B1.000 **Ford Engine Codes:** FD4
Always refer to the vehicle manufacturer for the correct use of this kit

| Stock No. | Box Qty | Price per kit |
|-----------|---------|---------------|
| 32804 | - | €307.50D |



5 ETK27

DRAPER Expert

Ford/Mazda/Volvo Timing Kit

Ford Engine Codes: ASDA, ASDB, DHA, DHB, DHC, DHD, DHE, DHF, DHG, F8JA, F8JB, FHA, FHD, FHE, FHF, FUJA, FUJB, FXDA/C, FXDB/D, FXJA, FXJB, M7JA, M7JB, SNJA, SPJA, STJA **Mazda Engine Codes:** DHA, FUJA, FUJB, FXJA, FXJB, FYJA, L8, LF, YF, L3
Volvo Engine Codes: B4164S3, B4184S11, B4204S
Always refer to the vehicle manufacturer for the correct use of this kit

| Stock No. | Box Qty | Price per kit |
|-----------|---------|---------------|
| 32805 | - | €62.48D |



6 ETK28

DRAPER Expert

Mini/PSA Timing Kit

Mini/PSA Engine Codes: N12, N14, EP3(8FS), EP6(5FW), EP6DT(5FX), EP6DTS(5FY), EX:5020DR
Always refer to the vehicle manufacturer for the correct use of this kit

| Stock No. | Box Qty | Price per kit |
|-----------|---------|---------------|
| 32810 | - | €386.25D |



1 ETK29
Renault Timing Kit

DRAPER Expert

Renault Engine Code:

K4J700, K4J710, K4J711, K4J712, K4J713, K4J714, K4J715, K4J730, K4J732, K4J740, K4J750, K4J770, K4J780, K4M700, K4M701, K4M704, K4M706, K4M708, K4M709, K4M710, K4M711, K4M712, K4M714, K4M716, K4M718, K4M720, K4M724, K4M730, K4M732, K4M734, K4M740, K4M742, K4M743, K4M744, K4M745, K4M746, K4M748, K4M750, K4M752, K4M753, K4M760, K4M764, K4M766, K4M782, K4M790, K4M791, K4M792, K4M794, K4M800, K4M801, K4M802, K4M804, K4M812, K4M813, F4P720, F4P722, F4P760, F4P770, F4P771, F4P772, F4P773, F4P774, F4P775, F4R700, F4R701, F4R712, F4R713, F4R714, F4R715, F4R720T, F4R722T, F4R730, F4R732, F4R740, F4R741, F4R744, F4R746, F4R770, F4R771, F4R776T, F4R780, F4R784T, F4R786T, F4R787T, F4R790, F4R791, F4R792, F4R794T, F4R795T, F4R796T, F4R797T, F4R820T, F4R830

Always refer to the vehicle manufacturer for the correct use of this kit

| Stock No. | Box Qty | Price per kit |
|-----------|---------|---------------|
| 32812 | - | €386.25D |



4 ETK32
VAG/Ford/Mitsubishi/Dodge Timing Kit

DRAPER Expert

VAG Engine Codes:

ANY, AYZ, AMF, ATL, BAY, BHC, BMS, BNM, BNV, BWB, AJM, AMG, ANU, ARL, ASZ, ATD, ATJ, AUJ, AVB, AVF, AVQ, AWX, AXB, AXC, AXR, BEW, BJB, BKC, BKE, BLS, BLT, BMT, BPX, BPZ, BRB, BRM, BRR, BRS, BRU, BSU, BSV, BSW, BTB, BUK, BVK, BXE, BXF, BXJ, AZV, BDJ, BDK, BGW, BHW, BKD, BKP, BLB, BMA, BMM, BMN, BMP, BMR, BNA, BPW, BRC, BRD, BRE, BRF, BRT, BSS, BUY, BUZ, BVA, BVF, BVG, BVH, BWV, BST, BDJ, BDK, CFWA, CAYA, CAYB, CAYC, CAYD, CAYE, CLNA, CAAA, CAAB, CAAC, CAAE, CAGA, CAGB, CAGC, CAHB, CBAA, CBAB, CBAC, CBBA, CBBB, CBDA, CBDB, CBDC, CBEA, CCHA, CCHB, CDBA, CDCA, CECA, CFCA, CFFA, CFFB, CFFD, CFFE, CFGB, CFGC, CFGD, CFHA, CFHB, CFHC, CFHD, CFHE, CFHF, CFJA, CGLA, CGLB, CGLC, CGLD, CJAA, CJCA, CJCB, CLCA, CLCB, CLJA, CLLA, CLLB, CMEA, CMFA, CMGA, CMGB

Ford Engine Codes: ANU, ASZ, AUJ

Mitsubishi Engine Codes: BSY

Dodge Engine Codes: ECD

Always refer to the vehicle manufacturer for the correct use of this kit

| Stock No. | Box Qty | Price per kit |
|-----------|---------|---------------|
| 32816 | - | €243.73D |



2 ETK30
VAG Timing Kit

DRAPER Expert

VAG Engine Codes:

AAB, AJA, AGX, ACV, AHD, AHY, AJT, ANJ, APA, AUF, AXG, AXL, AYC, BBE, BBF, BJJ, BJK, BJJ, BJM

Always refer to the vehicle manufacturer for the correct use of this kit

| Stock No. | Box Qty | Price per kit |
|-----------|---------|---------------|
| 32813 | - | €248.75D |



5 ETK33
VAG Timing Kit

DRAPER Expert

VAG Engine Codes: CBZA, CBZB, CBZC

Always refer to the vehicle manufacturer for the correct use of this kit

| Stock No. | Box Qty | Price per kit |
|-----------|---------|---------------|
| 32825 | - | €79.88D |



3 ETK31
VAG Timing Kit (Petrol and Diesel)

DRAPER Expert

VAG Engine Codes:

1F, ABM, ADA, ADP, AEH, AEK, AFT, AHL, AKL, AKS, ALZ, ANA, APF, ARM, AUR, AVU, AYD, BFQ, BFS, BGU, BSE, BSF, ABS, ADR, ADZ, AGN, AJP, AMU, APG, APT, APX, ARG, AW, BFV, BVP, BVR, AEB, AGU, AJH, AJL, AJQ, AMK, ANB, APP, APU, APY, AQA, AQX, ARX, ARY, ARZ, AUM, AUQ, AVC, AWC, AWT, AWU, AYP, BAM, ADL, 2E, AAC, AAE, ABK, ABT, ACE, ADY, AEG, AGG, AKT, APK, AQY, ATM, ATU, AWF, AWG, AXA, AZG, AZH, AZJ, AZL, AZM, BEH, ABF, AXW, BGB, BHD, BMB, BPJ, BPY, AHB, AHG, AKU, AKW, 1X, 1Y, AAZ, ABL, AEF, AEY, AGD, AGP, AQM, ASX, ASY, AYQ, 1Z, AFF, AFN, AGR, AHF, AHH, AHU, ALE, ALH, ASV, AVG

Always refer to the vehicle manufacturer for the correct use of this kit

| Stock No. | Box Qty | Price per kit |
|-----------|---------|---------------|
| 32814 | - | €224.98D |



6 ETK34
VAG Timing Kit

DRAPER Expert

VAG Engine Codes:

AXU, BKG, BLN, BLG, BMY, BWK, CAVA, CAVB, CAVC, CAVD, CAVF, CAXA, CDGA, BAG, BLF, BLP, BTS

Always refer to the vehicle manufacturer for the correct use of this kit

| Stock No. | Box Qty | Price per kit |
|-----------|---------|---------------|
| 32826 | - | €187.48D |

www.drapertools.com/timingtools

BOX QUANTITY INFORMATION

FOR YOUR CONVENIENCE, WE RECOMMEND ORDERING IN BOX QUANTITY OR MULTIPLES OF BOX QUANTITY WHERE SHOWN. YOU CAN STILL ORDER IN ANY QUANTITY UNLESS SPECIFICALLY STATED OTHERWISE

NEW

timing & locking tool range



1 ETK35

DRAPER Expert

Vauxhall/Suzuki Timing Kit

Vauxhall Engine Codes:

X10XE, Z10XE, Z10XEP, X12XE, Z12XE, Z12XEP, Z14XEL, Z14XEP

Suzuki Engine Codes: Z10XEP, Z12XEP

Always refer to the vehicle manufacturer for the correct use of this kit

| Stock No. | Box Qty | Price per kit |
|-----------|---------|---------------|
| 32827 | - | €131.23D |

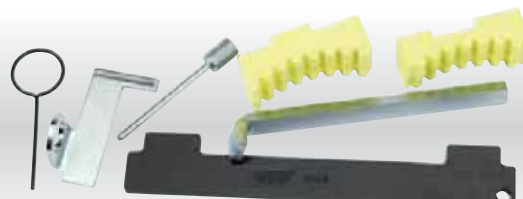

3 ETK37

DRAPER Expert

Vauxhall/Chevrolet/Fiat/Alfa Romeo Timing Kit

Vauxhall Engines Codes:

Z16LEL, Z16LER, Z16LET, Z16XE1, Z16XEP, Z16XER, A16XER, LDE, Z18XER, A18XER, 2H0

Chevrolet Engines Codes: G14D, LDE, LLU, LXV, 2H0

Fiat Engines Codes: 939A4.000 **Alfa Romeo Engines Codes:** 939A4.000

Always refer to the vehicle manufacturer for the correct use of this kit

| Stock No. | Box Qty | Price per kit |
|-----------|---------|---------------|
| 32829 | - | €124.98D |



2 ETK36

DRAPER Expert

Vauxhall/Chevrolet Timing Kit

Vauxhall Engine Codes:

A10XEP(LDB), A12XEL(LWD), A12XER(LDC), A14XEL(L2Z), A14XER(LDD), A14NEL, A14NET, A14NEL(LUH), A14NET(LUJ)

Chevrolet Engine Codes:

L2Q(A12XEL), LDC(A12XER), LWD(A12XEL), LDD(A14XEL), LDD(A14XER)

Always refer to the vehicle manufacturer for the correct use of this kit

| Stock No. | Box Qty | Price per kit |
|-----------|---------|---------------|
| 32828 | - | €274.98D |

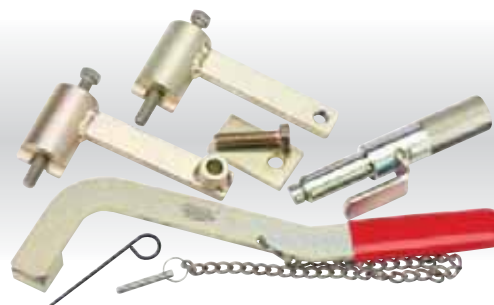

4 ETK38

DRAPER Expert

Volvo/Renault Timing Kit

Volvo Engines Codes:

B4164S, B4164S2, B4184S, B4184S2, B4184S3, B4184S10, B4184S9, B4194T, B419T2, B5204T2, B5204T3, B5204T4, B4204S, B4204S2, B4204T, B4204T2, B4204T3, B4204T5, B5204T5, B5202FS, B5234T4, B5234T5, B5234T3, B5234T6, B5234T9, B5234T7, B5234FS, B5244S, B5244T, B5244T7, B5244S2, B5244SG, B5244SG2, B5244T3, B5244T4, B5244T5, B5254T, B5254FS, B5254T4, B5254T2

Renault Engines Codes:

N7Q(704), N7Q(710), N7Q(711), N7U(700), N7U(701)

Always refer to the vehicle manufacturer for the correct use of this kit

| Stock No. | Box Qty | Price per kit |
|-----------|---------|---------------|
| 32830 | - | €159.38D |

Can't find what you're looking for?

To make locating the vehicle service tool you need easier, we have put all the products in this section in special sub-categories (see below).

Don't forget, you can also search using the alphabetical index on pages 830-842 or the unique five-figure Stock No. index - on pages 794-829.

76-83 timing tools
 84-93 diagnostics
 94-96 automotive specialised socketry
 97-105 engine and transmission
 106-107 cooling
 108-110 steering and suspension

111-117 brakes
 118-122 tyres and wheels
 123-127 bodywork and windscreen
 128 motorcycle tools
 129-132 breakdown and recovery
 133-141 consumables and accessories



DRAPER Expert



1 DTK-FORD
7 piece Ford Diesel Engine Injection Timing Kit

Expert Quality, for use on Ford 1.6 and 1.8 diesel injection engines. Kit is manufactured from mild steel and chemically blacked. Display packed in handy plastic case.

| Stock No. | Box Qty | Price per kit |
|-----------|---------|---------------|
| 52576 | 2 | €31.30D |

PRODUCT INFORMATION

Every effort has been made to ensure that the applications shown in this Draper Tools Catalogue are accurate and include all the current car/van models. When using specialized automotive tools ALWAYS refer to the vehicle manufacturer's service or relevant Haynes manual for detailed and concise instruction of usage.



2 DTK-MULTI1
13 piece Diesel and Petrol Engine Timing Kit

For use on Audi, Citroën, Peugeot, Volkswagen and Volvo petrol and diesel engines cars and light commercial vehicles. Manufactured from mild steel with plated finish. Display packed in blow mould storage case.

| Stock No. | Box Qty | Price per kit |
|-----------|---------|---------------|
| 57629 | - | €45.90D |

DRAPER Expert



3 CLT/TWIN
Universal Twin Cam Locking Tool

Expert Quality, easily adjusted tool locks twin camshafts in their timed position when replacing the timing belt. Supplied with extension for wider spaced cams and blow mould case. Display packed.

| Stock No. | Box Qty | Price each |
|-----------|---------|------------|
| 23256 | - | €71.63D |

DRAPER Expert



4 CLT5
Volkswagen Diesel Engine Crankshaft Locking Tool

Expert Quality, for locking crankshafts on Lupo 1.2TDI, Lupo 1.4TDI, Polo 1.4TDI, Golf 1.9TDI, Bora 1.9TDI and Passat 1.9TDI. diesel engines. Display packed.

| Stock No. | Box Qty | Price each |
|-----------|---------|------------|
| 71204 | - | €22.30D |



DRAPER Expert



5 CLT1
GM (Vauxhall/Opel) Camshaft Locking Tool

Expert Quality, for locking single and twin camshafts on GM (Vauxhall/Opel) Ecotec 1.4, 1.6 and 1.8L 16 valve petrol engines. Manufactured from anodized aluminium. Display packed.

| Stock No. | Box Qty | Price each |
|-----------|---------|------------|
| 69928 | - | €28.23D |

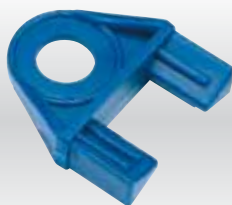

6 CLT-GM2
GM (Vauxhall/Opel) Twin Cam Locking Tool

For locking twin camshafts on GM (Vauxhall/Opel) Ecotec 1.8, 2.0 and 2.2L 16 valve petrol engines when undertaking maintenance. Display packed.

| Stock No. | Box Qty | Price each |
|-----------|---------|------------|
| 61276 | - | €9.00D |

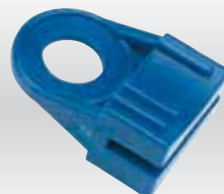

7 CLT-GM3
GM (Vauxhall/Opel) Camshaft Locking Tool

For locking single camshafts on GM (Vauxhall/Opel) Ecotec 1.4 and 1.6L 16 valve petrol engines when undertaking maintenance. Display packed.

| Stock No. | Box Qty | Price each |
|-----------|---------|------------|
| 61277 | - | €8.65D |



8 CLT-K16
Rover Group Camshaft Locking Tool

Locks camshaft when changing cam belts etc. For use with Rover Group Metro 1.4 (100 Series) GTa, GTi May 1990 on; Rover 214 16 valve Si, SLi, GSi Oct. 1989 on; Rover 414 16 valve Si, SLi, GSi March 1990 on. Manufactured from anodized aluminium. Display packed.

| Stock No. | Box Qty | Price each |
|-----------|---------|------------|
| 52306 | - | €5.35D |

BOX QUANTITY INFORMATION

FOR YOUR CONVENIENCE, WE RECOMMEND ORDERING IN BOX QUANTITY OR MULTIPLES OF BOX QUANTITY WHERE SHOWN. YOU CAN STILL ORDER IN ANY QUANTITY UNLESS SPECIFICALLY STATED OTHERWISE

VISIT OUR WEBSITE AND SEARCH THE STOCK No. FOR COMPLETE LISTING OF VEHICLE COMPATIBILITY
www.drapertools.com

DRAPER Expert



1 FCR-300

Diagnostic Fault Code Reader 300

Expert Quality, for the interrogation of engine management systems and the display and cancellation of diagnostic trouble codes (DTC's) in petrol, diesel and hybrid vehicles. Compatible with all EOBD petrol 2001 and diesel 2004 onwards and OBDII (US) 1996 onwards systems. This reader will read and display malfunction indicator status (MIL); display over 27,000 generic codes and manufacturer's vehicle specific codes; carries out 'Mode 6' displays; freeze frame, live data and VIN; display emissions status and graphs live engine data. Has standard 16pin EOBD connector with 790mm (approx.) cable. Display packed.

NB: will not interrogate or erase service indicator, ABS or airbag/SRS lights

| Stock No. | Box Qty | Price each |
|-----------|---------|------------|
| 21980 | - | €156.25P |

DIAGNOSTIC FAULT CODE READER 300

The attraction of this fault code reader is that it is capable of interrogating **all** EOBD vehicles - it's so stress-free and easy-to-use, all you have to do is plug in and go - no extensive training or expensive laptop required!



Graphs live data.



Displays Diagnostic Trouble Code (DTC) and definition.



Displays Vehicle Identification Number (VIN) where available.



SEE PRODUCT VIDEO
www.drapertools.com/drapertv



DRAPER Expert



2 FCR-200

Diagnostic Fault Code Reader 200

Expert Quality, for the interrogation of engine management systems and the display and cancellation of diagnostic trouble codes (DTC's) in petrol and diesel vehicles. Compatible with all EOBD petrol 2001 and diesel 2004 onwards and OBDII (US) 1996 onwards systems. This reader will read and display malfunction indicator status (MIL); display over 4000 generic codes and their definitions; display freeze frame and live engine data; reads and displays VIN; displays emissions status. Has standard EOBD 16pin connector with 790mm (approx.) cable. Display packed.

NB: will not interrogate or erase service indicator, ABS or airbag/SRS lights

| Stock No. | Box Qty | Price each |
|-----------|---------|------------|
| 21979 | - | €111.25P |



VISIT OUR WEBSITE AND SEARCH THE STOCK No. FOR COMPLETE LISTING OF VEHICLE COMPATIBILITY
www.drapertools.com

DRAPER Expert



3 EPBST

Electronic Parking Brake (EPB) Service Tool

Expert Quality, designed and manufactured to be used for safe replacement of brake pads on vehicles fitted with an EPB (electronic parking brake). Large easy to read backlit LCD screen with micro USB socket for updates via the internet. Can be used on Audi, Ford, Mercedes Benz, Volkswagen and Volvo. Supplied in carrying case with standard 16 pin EOBD connector. Display packed.

| Stock No. | Box Qty | Price each |
|-----------|---------|------------|
| 23660 | - | €177.28P |



DRAPER Expert



1 SRST

Service Reset Tool

Expert Quality, designed and manufactured to be used for safe professional resetting of the oil service/inspection lights and the adjustment of service interval data. Large easy to read backlit LCD screen with micro USB socket for updates via the internet. Can be used on Audi, BMW, Chrysler, Ford, Honda, Isuzu, Jeep, Land Rover, Mercedes Benz, Nissan, Saab, Seat, Skoda, Toyota/Lexus, GM (Vauxhall/Opel), Volvo, Volkswagen. Also suitable for many American cars. Standard 16 pin connector and adaptor for older BMW, Volkswagen and Mercedes vehicles. Supplied in carrying case with foam protection. Display packed.

Please visit our website for the latest software for Stock No.23659.

| Stock No. | Box Qty | Price each |
|-----------|---------|------------|
| 23659 | - | €271.43P |



DRAPER Expert



4 KFT

Vehicle Key Fob Tester

Expert Quality, detects radio and infrared wavelengths from vehicle key fobs and remote controls helping diagnose potential faults on the emitters. Operates between 418MHz and 434MHz. Carton packed.

| Stock No. | Description | Box Qty | Price each |
|-----------|---------------|---------|------------|
| 24446 | Tester | - | €68.18D |
| 61837 | Battery (PP3) | 12 | €7.38D |

DRAPER Expert



5 ACT2

12-48V Fuse Blade Automotive Amperage Testers

Expert Quality, for rapid and accurate amperage testing. 12-48V/20A AC/DC measuring range. Liquid Crystal Display screen shows readings. Plugs directly into fuse socket recess. Supplied with cable 750mm long. Uses 12V-A23 battery (supplied). Display packed.

| Stock No. | Spade Terminal Size | Box Qty | Price each |
|-----------|---------------------|---------|------------|
| 43060 | 3mm | - | €31.78D |



2 SMS

12V Socket Memory Saver

A 12V socket memory saver for vehicles WITHOUT an EOBD 16 pin socket. Fitted with a surge protector and LED indicators to maintain an uninterrupted power supply to the vehicle's ECU unit for security coded radios, on board digital clocks and other settings within the ECU's memory. The memory saver plugs into a conventional cigarette lighter and is powered by the vehicle's 12V battery. Supplied with 2.5M cable and crocodile clips. Carton packed.

| Stock No. | Box Qty | Price each |
|-----------|---------|------------|
| 22277 | - | €23.15D |



3 EMS

EOBD Memory Saver

Allows removal of vehicle batteries without losing memories or settings for ICE systems, digital clocks, trip computers from the ECU (engine control unit). Uses 16 pin plug with reverse polarity protection. Supplied with 2.7M (approx.) of cable with crocodile clips for attachment to slave battery and in-line fuse. Display packed.

| Stock No. | Box Qty | Price each |
|-----------|---------|------------|
| 22231 | - | €39.43D |



PRODUCT INFORMATION

Every effort has been made to ensure that the applications shown in this Draper Tools Catalogue are accurate and include all the current car/van models. When using specialized automotive tools ALWAYS refer to the vehicle manufacturer's service or relevant Haynes manual for detailed and concise instruction of usage.

BOX QUANTITY INFORMATION

FOR YOUR CONVENIENCE, WE RECOMMEND ORDERING IN BOX QUANTITY OR MULTIPLES OF BOX QUANTITY WHERE SHOWN. YOU CAN STILL ORDER IN ANY QUANTITY UNLESS SPECIFICALLY STATED OTHERWISE



1 DMM5

Digital Automotive Analyser

Expert Quality, Ideal for automotive use. Display packed.

Features include:

- 24 position rotary function and range selector;
- Measures DC volts and DC amps; • Measures resistance and dwell angle; • Takes tachometer readings;
- Diode test facility; • Audible continuity tester; • Impact resistant rubber case; • Recessed input terminals; • Low battery indicator; • Test leads (probes and crocodile clips)

Specification:

| | |
|---------------------|--|
| DC amps | ... 10A |
| DC volts | ... 200mV, 2, 20, 200 and 1000V |
| Resistance (Ohms) | ... 200, 2k, 20k, 200k, 2M and 20M |
| Tachometer (x10rpm) | ... 500-10,000 |
| Dwell angle | ... 3 cyl. 0-120°; 4 cyl. 0-90° 5 cyl. 0-120°; 6 cyl. 0-60° 8 cyl. 0-45° |
| Battery (supplied) | ... 1 x 9V PP3 type |
| Size (W x H x D) | ... 70 x 147 x 39mm |
| Weight: | ... 189g |

| Stock No. | Description | Box Qty | Price each |
|-----------|---------------------|---------|------------|
| 50024 | Automotive Analyser | — | €67.95D |
| 53551 | Probe Set | — | €7.53D |
| 61837 | Battery (PP3) | 12 | €7.38D |

DAVE SAYS

DIGITAL AUTOMOTIVE ANALYSER (Item Nos. 1 & 2) A "must" for any auto technician or home mechanic. R/min and dwell features for 1, 2, 3, 4, 5, 6, 8, 10 and 12 cylinder vehicles and...yes they will do twin and single cylinder motorcycles. Just set it to 4 cylinder and double the reading for twin cylinder machines, or quadruple it for single cylinder machines.



QUALITY MAKES THE DIFFERENCE



2 DMM14

Digital Autoringing Automotive Analyser

Expert Quality, with autoringing facility on AC/DC voltage and resistance. Ideal for automotive use. Display packed.

Features include:

- 24 position rotary function selector; • Measures AC and DC volts/amps (autoringing); • Measures resistance (autoringing) and dwell angle; • Takes tachometer readings; • Measures duty cycle and frequency; • Diode test facility; • Audible continuity tester; • Temperature sensor; • Impact resistant rubber case; • Recessed input terminals; • Low battery indicator; • Heavy duty inductive pick up; • Test leads (probes and crocodile clips)

Specification:

| | |
|---------------------|---|
| DC volts | ... 320mV, 3.2, 32, 320 and 1000V |
| AC volts | ... 3.23232 and 750V |
| DC current | ... 320µ and 3200µA, 33mA 320mA and 10A |
| AC current | ... 320µ and 3200µA, 33mA 320mA and 10A |
| Resistance (Ohms) | ... 320, 3.2, 32k, 3.2M and 32M |
| Tachometer (x10rpm) | ... RPM4 600-3200 RPM2 300-3200 |
| Dwell angle | ... 3 cyl. 0-120°; 4 cyl. 0-90° 5 cyl. 0-72°; 6 cyl. 0-60° 8 cyl. 0-45° |
| Duty cycle | ... 1 - 90% |
| Frequency | ... 320Hz, 3200Hz and 32KHz |
| Temperature range | ... -20 to 750°C and -4 to 1400°F |
| Battery (supplied) | ... 1 x 9V PP3 type |
| Size (W x H x D) | ... 91 x 189 x 32mm |
| Weight: | ... 280g (analyser only) |

| Stock No. | Description | Box Qty | Price each |
|-----------|---------------------|---------|------------|
| 61023 | Automotive Analyser | — | €127.10D |
| 61837 | Battery (PP3) | 12 | €7.38D |

NEW

DRAPER Expert



3 DCM2

Autoringing Digital Clamp Meter

Expert Quality, auto-ranging digital clamp meter with 600Amp capacity on both AC & DC. 30mm diameter cable clamp is perfect for automotive use. Low power LCD display and auto power off facility delivers low battery consumption. Fitted with continuity buzzer, safety lanyard and supplied with fully insulated test leads, needle probe, temperature probe and protective carry case. Battery (PP3) supplied. Display packed.

Specification:

| | |
|--------------------|-----------------------------------|
| DC volts | ... 400mV - 600V |
| AC volts | ... 400mV - 600V |
| DC current | ... 0.6A - 400A |
| DC current | ... 0 - 600A |
| AC current | ... 0.6A - 400A |
| AC current | ... 0 - 600A |
| Resistance (Ohms) | ... 400Ω, 4to 40MΩ |
| Duty cycle | ... 1 - 90% |
| Temperature range | ... -20 to 760°C and -4 to 1400°F |
| Battery (supplied) | ... 1 x 9V PP3 type |
| Weight: | ... 280g (meter only) |

| Stock No. | Description | Box Qty | Price each |
|-----------|---------------|---------|------------|
| 34280 | Clamp Meter | — | €169.98D |
| 61837 | Battery (PP3) | 12 | €7.38D |



NEW

INFRARED THERMOMETER

BENEFITS OF A 12:1 RATIO THERMOMETER

When buying an infrared thermometer, pay attention to the distance to spot ratio. Essentially this means the further you are away from the object the wider the area the thermometer measures and as all infrared thermometers measure average surface temperature, the smaller the beam the more accurate the reading. So if you want accurate readings the higher the ratio the more accurate the reading which makes a 12:1 ratio a better diagnostic tool than a 6:1 ratio.

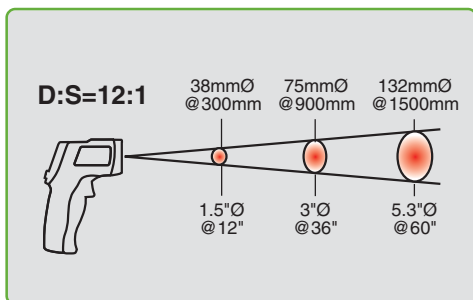

1 IT12:1

Infrared Thermometer

An easy to use 12:1 ratio infra-red thermometer. This compact and portable tool enables professionals to diagnose heating/cooling problems and monitor the temperature on electrical motors, electrical panels, automotive exhausts and radiators etc; without contact. Manufactured with enhanced optics for delivering supreme accuracy between the temperature range -50 to 550C (-58 to 1022F). Display packed.

| Stock No. | Box Qty | Price each |
|-----------|---------|------------|
| 31910 | - | €62.44D |



4 1177

In-Line H.T. Ignition Tester

Establishes whether there is a high tension spark potential at the spark plug. Hands free operation means no risk of electric shock to user. Ideal for modern vehicles with sensitive electronics. Probe is 55mm long with a lead 100mm in length. Display packed.

| Stock No. | Box Qty | Price each |
|-----------|---------|------------|
| 38898 | 6 | €10.83D |

5 1179

4 piece H.T. System Tester Set

Four testers suitable for quick checking of H.T. systems. Indicates if voltage is present in H.T. leads and helps identify whether problem is with H.T. leads or L.T. parts (coil, distributor etc.). Can be used in all cylinder combinations. Display packed.

| Stock No. | Box Qty | Price per set |
|-----------|---------|---------------|
| 56495 | 6 | €16.75D |



6 INL6/KIT

6 piece Injector Noid Light Kit

Quick, efficient and economic way to fault find on the following electronic fuel (EFI) systems: GM PFI, GM TBI, GM SCPI, Ford TBI, GEO TBI and Bosch PFI. Packed in blow mould case. Display carton.

| Stock No. | Box Qty | Price per kit |
|-----------|---------|---------------|
| 57798 | - | €26.18D |

PRODUCT INFORMATION

Every effort has been made to ensure that the applications shown in this Draper Tools Catalogue are accurate and include all the current car/van models. When using specialized automotive tools ALWAYS refer to the vehicle manufacturer's service or relevant Haynes manual for detailed and concise instruction of usage.



2 DMM18

Automotive Tachometer

Measures two stroke, four stroke and distributorless ignition systems (DIS) by inductive pickup. Display packed.

Features/functions include: • 1 to 8 cylinder; • x10 reading; • Data holding facility; • Large 2000 count LCD; • Low battery indicator; • Auto power off

Specification:

| | |
|--------------------|-------------------------|
| R/min4 | ... 600-2000 (x10r/min) |
| R/min2 | ... 300-3200 (x10r/min) |
| Battery (supplied) | ... 1 x 9V PP3 type |
| Size (W x H x D) | ... 76 x 155 x 47mm |
| Weight: | ... 210g |

| Stock No. | Description | Box Qty | Price each |
|-----------|---------------|---------|------------|
| 79005 | Tachometer | - | €59.30D |
| 61837 | Battery (PP3) | 12 | €7.38D |



3 TL3

Pistol-Grip Xenon Timing Light

Suitable for checking ignition timing on automotive, agricultural and marine engines (12V DC). Features include xenon bulb and inductive pick-up. Impact-resistant housing with on/off trigger. Display packed.

NB: Not for use with motorcycles, low power, or positive earth vehicles.

| Stock No. | Box Qty | Price each |
|-----------|---------|------------|
| 52616 | - | €76.03D |

BOX QUANTITY INFORMATION

FOR YOUR CONVENIENCE, WE RECOMMEND ORDERING IN BOX QUANTITY OR MULTIPLES OF BOX QUANTITY WHERE SHOWN. YOU CAN STILL ORDER IN ANY QUANTITY UNLESS SPECIFICALLY STATED OTHERWISE

STOCKIST INFO
REVISED DEALER
CODE APPLIES TO
THIS ITEM



1 DP

NEW

DRAPER Expert

12-24V Automotive Diagnostic Probe

Expert Quality, easy to use alternative to automotive oscilloscopes, allows safe use with all sensors and ECUs on vehicles. Toggle between voltage, frequency or duty modes at the push of a button and test for open or short circuits. The inbuilt flashlight allows you to easily find your target even in the darkest of environments. Simple to use probe makes trouble-shooting fast, easy, and accurate. Display packed.

Warning: For testing DC circuits on vehicles within the voltage range only. Not suitable for testing mains supply AC circuits.

| Stock No. | Box Qty | Price each |
|-----------|---------|------------|
| 30647 | - | €93.70P |



2 1176

Battery and Alternator Analyser

Checks battery charge level and alternator output level. 880mm of insulated cable with test probe and earth (crocodile) clip. For 12V DC systems only. Display packed.

Warning: For testing DC circuits on vehicles within the voltage range only. Not suitable for testing mains supply AC circuits.

| Stock No. | Box Qty | Price each |
|-----------|---------|------------|
| 36584 | 4 | €20.95D |



3 1182

3-12V Automotive Multi-Tester

Suitable for checking continuity/broken wires, finding live wires, other DC voltage testing from 3-12V, vehicle battery testing, spark plug ignition voltage test. Suitable for 3-12V DC systems. Display packed.

Warning: For testing DC circuits on vehicles within the voltage range only. Not suitable for testing mains supply AC circuits.

| Stock No. | Box Qty | Price each |
|-----------|---------|------------|
| 57680 | - | €17.45D |



4 1181

DRAPER Expert

6-24V Heavy Duty Automotive Circuit Tester

Expert Quality, with insulated blade 170mm long, 3.5M approx. (stretched) of recoil lead and heavy duty earth (crocodile) clip. Testing range 6-24V DC Display packed.

Warning: For testing DC circuits on vehicles within the voltage range only. Not suitable for testing mains supply AC circuits.

| Stock No. | Box Qty | Price each |
|-----------|---------|------------|
| 56498 | 2 | €33.38D |



6 1175

6-24V Automotive Circuit Tester

Circuit tester with 1.5M of heavy duty cable and earth (crocodile) clip. Insulated contact point to prevent accidental shorting. Testing range 6-24V DC. Display packed.

Warning: For testing DC circuits on vehicles within the voltage range only. Not suitable for testing mains supply AC circuits.

| Stock No. | Box Qty | Price each |
|-----------|---------|------------|
| 36583 | 4 | €16.63D |

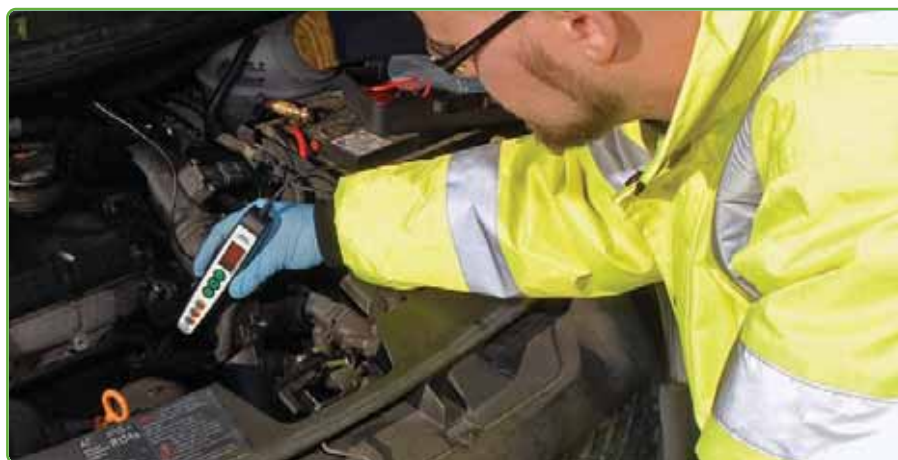

NEW



5 1170B

DRAPER Expert

6-24V Automotive Circuit Tester

Expert Quality, tester with solid brass body housing a test light. Insulation piercing contact point with protective screw cap. Testing range 6-24V DC Supplied with 650mm of insulated cable with crocodile clip. Display packed.

Warning: For testing DC circuits on vehicles within the voltage range only. Not suitable for testing mains supply AC circuits.

| Stock No. | Box Qty | Price each |
|-----------|---------|------------|
| 32667 | 6 | €7.03D |



7 1169

6-24V Automotive Circuit Tester

Circuit tester with transparent plastic handle housing neon light. Testing range 6-24V DC. Supplied with 750mm of insulated cable with crocodile clip. Display packed.

Warning: For testing DC circuits on vehicles within the voltage range only. Not suitable for testing mains supply AC circuits.

| Stock No. | Blade Tip | Box Qty | Price each |
|-----------|-----------|---------|------------|
| 12578 | 3mm | 6 | €4.38D |

SAFETY INFORMATION

VEHICLE ELECTRIC CIRCUIT TESTERS

Items 1-7 on this page are only suitable for checking automotive DC circuits **not** mains AC circuits. See opposite, item 1 or pages 234, 369 and 775 for Mains Testing Screwdrivers.

NEW



1 VT2
AC/DC Voltage Tester

Twin LED indicators identify voltage between 12-600V. Suitable for testing a host of wiring around the home or workplace or vehicle circuitry and electronic equipment, etc. Probes fitted to 825mm of VDE approved cable. Display packed.

| Stock No. | Box Qty | Price each |
|-----------|---------|------------|
| 51957 | - | €21.23D |



RANGE:
0.8-2.6mm²/10-20AWG



DRAPER Expert

3 PWS20-10
20-10 AWG Wire Strippers

Expert Quality, pocket-sized for cutting and stripping cable and wire. Incorporates pliers in the jaws together with open/close lock keeps jaws closed when not in use. Wire stripping range 0.8-2.6mm²/20-10AWG. Spring-loaded jaws for one-handed operation. Supplied with two replacement chrome molybdenum stripping blades. Display packed.

| Stock No. | Box Qty | Price each |
|-----------|---------|------------|
| 26320 | 10 | €23.15D |



DRAPER Expert

2 WPG1
Wire Piercing Guide Clip

Expert Quality, quickly guides the point of a test probe to the centre of all 12V automotive wires. Three wire gauge size guides. Display packed.

| Stock No. | Box Qty | Price each |
|-----------|---------|------------|
| 43286 | - | €10.83D |



RANGE:
0.2-0.8mm²/30-20AWG



DRAPER Expert

4 PWS30-20
30-20 AWG Wire Strippers

Expert Quality, pocket-sized for cutting and stripping cable and wire. Incorporates pliers in the jaws together with open/close lock keeps jaws closed when not in use. Wire stripping range 0.2-0.8mm²/30-20AWG. Spring-loaded jaws for one-handed operation. Supplied with two replacement chrome molybdenum cable stripping blades. Display packed.

| Stock No. | Box Qty | Price each |
|-----------|---------|------------|
| 26319 | 10 | €23.15D |



5 SI15/12VA
12V DC 15W Soldering Iron

12V DC

Soldering iron with car cigarette lighter plug and 1.2M of cable. Supplied with straight tip. An ideal tool for use in vehicles and by model makers. Display packed.

| Stock No. | Description | Box Qty | Price each |
|-----------|----------------|---------|------------|
| 71422 | Soldering Iron | - | €13.00D |
| 71931 | Spare 25W Tip | - | €5.88D |



6
Flux Cored Solder

K60/40 tin/lead, supplied in tubes and reels. Display packed.

Not for use in potable water systems

| Stock No. | Part No. | Weight | Type | Box Qty | Price each |
|-----------|----------|--------|------|---------|------------|
| 19225 | SW 1 | 20g | Tube | - | €3.98D |
| 44040 | SW 2A | 100g | Reel | - | €14.73D |
| 19227 | SW 3 | 250g | Reel | - | €28.73D |



7 TSTC
13 Pin to 7 Pin Socket Converter

Used in conjunction with Draper 65535 towing socket testers or other manufacturers testers to enable the conversion of UK standard 7 pin 'N type' socket to European standard 13 pin 'N type' socket. Display packed.

| Stock No. | Box Qty | Price each |
|-----------|---------|------------|
| 23615 | - | €23.05D |

PRODUCT INFORMATION

Every effort has been made to ensure that the applications shown in this Draper Tools Catalogue are accurate and include all the current car/van models. When using specialized automotive tools ALWAYS refer to the vehicle manufacturer's service or relevant Haynes manual for detailed and concise instruction of usage.

BOX QUANTITY INFORMATION

FOR YOUR CONVENIENCE, WE RECOMMEND ORDERING IN BOX QUANTITY OR MULTIPLES OF BOX QUANTITY WHERE SHOWN. YOU CAN STILL ORDER IN ANY QUANTITY UNLESS SPECIFICALLY STATED OTHERWISE



DRAPER Expert

FOR COMMERCIAL VEHICLES

1 DCT6CV

13 piece Commercial Vehicle Diesel Engine Compression Test Kit

Expert Quality, allows the compression of commercial diesel engines (direct or indirect fuel injection) to be tested by cranking. Large easy-to-read scale measuring 0-1000psi/0-70kg/cm² with 600mm of flexible hose and push on adaptor incorporating a Schrader one way valve. Side pressure relief valve allows rapid retesting. Display packed in plastic blow mould storage case with sleeve. Contents: • Gauge with flexible hose • Threaded dummy glowplug • 3 threaded dummy glowplug adaptors size: 20.5 x 30, 23.6 x 32 and 23.6 x 41mm • 5 adaptor sleeves size: 6, 12, 18, 25 and 38mm • 90° coupling • Assorted copper seals

| Stock No. | Box Qty | Price per kit |
|-----------|---------|---------------|
| 43053 | - | €199.98P |



DRAPER Expert

FOR CARS AND VANS

2 DCT5

12 piece Diesel Engine Compression Test Kit

Expert Quality, allows the compression of car and van diesel engines (direct or indirect fuel injection) to be tested by cranking. Large easy-to-read scale measuring 0-1000psi/0-70kg/cm² with 600mm of flexible hose and push on adaptor incorporating a Schrader one way valve. Side pressure relief valve allows rapid retesting. Display packed in blow mould storage case with sleeve.

Contents:

- Gauge with flexible hose • 2 Non-threaded dummy glowplugs • 7 threaded dummy glowplugs size: 3 x M10, 1 x M12, 1 x M14, 1 x M20 and 1 x M24 • 5 adaptor sleeves size: 6, 12, 18, 25 and 38mm • 90° coupling • 'H' bracket • Assorted copper and plastic seals

| Stock No. | Box Qty | Price per kit |
|-----------|---------|---------------|
| 43052 | - | €215.93P |



DRAPER Expert

CAN BE USED WITH LONG REACH ADAPTOR, STOCK No. 51012

3 PCT1

8 piece Petrol Engine Compression Test Kit

Expert Quality, allows the compression of petrol engines to be tested whilst running. Large easy-to-read scale measuring 0-290psi/0-20bar with 370mm of flexible hose and push on adaptor incorporating a Schrader one way valve. Side pressure relief valve allows rapid retesting. Display packed in blow mould storage case with sleeve.

Contents:

- Gauge with flexible hose • 5 adaptors size: M10, M12, 2 x M14 and M18 • 2 double-ended spark plug thread chasers size: M10/M12 and M14/18 • Assorted O rings

| Stock No. | Box Qty | Price per kit |
|-----------|---------|---------------|
| 43051 | - | €134.40P |



CAN BE USED WITH LONG REACH ADAPTOR, STOCK No. 51012

4 DCT1

Petrol Engine Compression Tester

Suitable for use on most petrol-engined vehicles including motorcycles. Comprises 300mm flexible hose, with 14mm and 18mm threaded adaptors, large easy-to-read scale (0-300psi/0-21bar) and air release valve to allow rapid retesting. Display packed.

| Stock No. | Description | Box Qty | Price each |
|-----------|-----------------------|---------|------------|
| 37442 | Tester | - | €26.80P |
| 50026 | M14 x M10/M12 Adaptor | - | €4.35P |

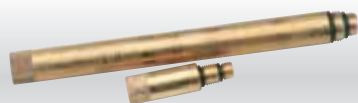

DRAPER Expert

5 LRA

200mm Long Reach Adaptor

Expert Quality, suitable for use in conjunction with petrol engine compression testers i.e. Draper Models DCT1 and PCT1 and similar products on engines with deep recessed spark plug apertures (i.e. Ford Mondeo, Renault). Thread sizes 14 x 18mm with adaptor 10 x 12mm. Display packed.

| Stock No. | Box Qty | Price each |
|-----------|---------|------------|
| 51012 | - | €25.03P |





1 OPTK1

12 piece Oil Pressure Test Kit

Expert Quality, for the accurate testing of oil pump pressure and also switch and warning indicators. Large easy-to-read scale measuring 0-145psi/0-10bar with 1.4M of flexible hose and push on adaptor incorporating a Schrader one way valve. Display packed in blow mould storage case with sleeve.

Contents:

- Gauge with flexible hose
- 10 pressure adaptors size: 1, 2, 3, 4, 5, 6, 7, 8, 9 and 10
- Assorted rubber seals

| Stock No. | Box Qty | Price per kit |
|-----------|---------|---------------|
| 43054 | - | €141.23P |



2 DVG1

Petrol Engine Vacuum and Fuel Pump Tester

Suitable for testing and fault finding the following in petrol engines including:

- Spark misfires; poor engine compression; weak/rich mixture; ignition over advanced/retarded; inlet manifold and carburettor air leaks; incorrect valve timing; poor fuel economy; balancing carburettors; turbo boost gauge; fuel pump testing. Display packed.

| Stock No. | Box Qty | Price each |
|-----------|---------|------------|
| 59075 | - | €13.90P |



3 VAC1A

Vacuum Test Kit

Expert Quality, designed to help locate and identify faults on vehicles. Applications include fuel, ignition, ignition transmission, air conditioning, fuel lines, emissions, vacuum brake and clutch bleeding. Diecast body with gauge and accessory kit. Easily dismantled for cleaning. Display packed in blow mould storage case with sleeve.

Contents:

- Hose end cones: 4 x small; 2 x medium; 1 x large
- Bleed nipple adaptors: 1 each of small, medium, large
- Gun cones: x 2 • Hose adaptor
- Suction cup 32mm diameter
- Reservoir 120ml • Extension tubes: x 9

Specification:

| | |
|----------------------|---------------------------|
| Piston stroke volume | ... 1 cubic inch |
| Range | ... 0 - 76cm Hg of vacuum |

| Stock No. | Box Qty | Price per kit |
|-----------|---------|---------------|
| 68714 | - | €80.00P |



4 STETH1

Mechanics Stethoscope

Suitable for detecting faults in engines, bearings and other moving parts. Supplied with two probes 290mm long. Display packed.

| Stock No. | Box Qty | Price each |
|-----------|---------|------------|
| 54503 | 10 | €26.38D |

NEW



5 CRDIFK-2B

Diesel Flow & Adaptors Kit

Expert Quality comprehensive kit essential for determining the return flow from diesel injectors. The fuel return flowmeters allow precise measurement for swiftly diagnosing faulty or damaged injectors. Supplied with a selection of adaptors and is capable of measuring six injectors simultaneously. Packed in portable plastic case.

Contents:

- 6 x manometer tubes for use when cranking engine
- 6 x reservoir bottles for use when running the engine for longer periods
- 12 x push fit adaptors • Anodized hanging bottle rack
- 6 x Bosch Injector adaptors (No.1)
- 6 x Siemens Injector adaptors (No.2)
- 6 x Denso Injector adaptors (No.3)
- 6 x Delphi Injector adaptors (No.4)

| Stock No. | Box Qty | Price per kit |
|-----------|---------|---------------|
| 31001 | - | €118.75P |



DRAPER®

WORKSHOP EQUIPMENT

We have an extensive range of professional quality workshop tools and equipment.

The following product groups are just a small part of our range...



Lifting Equipment

pages 144-163

Engine Cranes, Gearbox Supports, Transmission Stands, and a range of Trolley and Bottle Jacks, all these products and lots more are in section 3 of this catalogue.



Welding Tools

pages 539-554

Turn to the welding section to find the right ARC, MIG or TIG welding machine.

We also have a vast selection of accessories to choose from.

BOX QUANTITY INFORMATION

FOR YOUR CONVENIENCE, WE RECOMMEND ORDERING IN BOX QUANTITY OR MULTIPLES OF BOX QUANTITY WHERE SHOWN. YOU CAN STILL ORDER IN ANY QUANTITY UNLESS SPECIFICALLY STATED OTHERWISE



DRAPER Expert

1 CGDK

Combustion Gas Leak Detector Kit

Expert Quality, block or combustion leak tester for determining if CO² is present in a vehicle's cooling system. CO² in the cooling system can indicate a head gasket leak, cracked block or a warped head, etc. Simple to operate by adding blue detector fluid to the tester and placing tester onto the radiator; air is drawn through the liquid which will change colour to yellow if CO² is present. Can be used in conjunction with a cone adaptor or an adaptor within the Draper Radiator Pressure Test Kit (Stock Nos. 14455 and 23420). Supplied with detector fluid. Display packed.

| Stock Part No. | Description | Box Qty | Price per kit |
|----------------|--------------------|---------|---------------|
| 23257 CGDK | Leak Detector | - | €148.68P |
| 23304 CGDK-RF | 250ml C/Leak Fluid | - | €34.00P |



DRAPER Expert

2 CGDK-RF

250ml Combustion Gas Detector Fluid

Expert Quality, suitable for use with the Draper Combustion Leak Detector and other manufacturer's similar detectors. Display packed.



| Stock No. | Box Qty | Price each |
|-----------|---------|------------|
| 23304 | - | €34.00P |



DRAPER Expert

3 RPT33

33 Piece Radiator and Cap Pressure Test Kit

Expert Quality, for pressure testing radiators of most popular vehicles. Will also pressure test radiator caps for leakage. 33 colour coded adaptors allow direct connection to radiator or expansion tank. Hand pump with gauge graduated with BAR and PSI allows simple and easy controlled pressurization via a quick coupling system. Pressure release pin allows system to be depressurized prior to detachment. Supplied in carrying case with display sleeve.

| Stock No. | Box Qty | Price per kit |
|-----------|---------|---------------|
| 23420 | - | €276.85P |



DRAPER Expert

4 RTP1

20 Piece Radiator Pressure Test Kit

Expert Quality, for pressure testing radiators of most popular vehicles. 20 custom adaptors allow direct connection to radiator or expansion tank. Hand pump with gauge allows simple and easy controlled system pressurization via a quick coupling system. Pressure release pin allows system to be depressurized prior to detachment. Supplied in carrying case with display sleeve.

| Stock No. | Box Qty | Price per kit |
|-----------|---------|---------------|
| 14455 | - | €202.05P |



DIAGNOSTICS/INSPECTION CAMERAS

INSPECTION CAMERAS

Industry-standard cameras that will save hours of work when looking into areas that are not directly accessible with the naked eye. Item Nos. 1 and 2 have SD-HC memory card facility which allows the user to store information from the inspection camera to file or study later on.

SEE PRODUCT VIDEO
www.drapertools.com/drapertv 



8.8mm dia. water-proof camera head illuminated by variable brightness LED's

EXCLUSIVE TO DRAPER TOOLS IN THE UK & EIRE

3.5" TFT high resolution LCD screen allows a clear and precise view of the workpiece

Accessories

Phono TV connection lead

USB cable

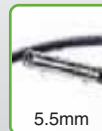

5.5mm dia. water-proof camera head illuminated by variable brightness LED's

EXCLUSIVE TO DRAPER TOOLS IN THE UK & EIRE

3.5" TFT high resolution LCD screen allows a clear and precise view of the workpiece

Mirror

Phono TV connection lead

USB cable

1 CAM6

Recording Flexi Inspection Camera with SD-HC Memory Card Slot and 8.8mm dia. Camera Probe

State-of-the-art camera with a tiltable 3.5" TFT LCD colour screen. Fitted with 1M by 8.8mm diameter flexible waterproof camera probe illuminated by variable brightness LED's. Gives high resolution images in areas difficult to see with the naked eye - i.e. inside of cylinder chambers, vehicle door spaces, corrosion checks and many other uses in the automotive, building and maintenance industries. Features full video motion recording and still photograph capture onto standard SD-HC memory card (supplied separately). Built-in microphone/speaker and flexible handle with stops at 0°, 45° and 80°. Complete with USB cable, phono TV connection (RCA) lead and clip-on hook, mirror and magnet accessories. Powered by four AA batteries (supplied separately). Display packed.

| Stock No. | Description | Box Qty | Price each |
|-----------|--------------------|---------|------------|
| 05162 | Camera | - | €280.98P |
| 61834 | Batteries (4 x AA) | - | €4.38D |

2 CAM7

Recording Flexi Inspection Camera with SD-HC Memory Card Slot and 5.5mm dia. Camera Probe

State-of-the-art camera with a tiltable 3.5" TFT LCD colour viewing screen and 1M flexible waterproof probe with a 5.5mm diameter camera head illuminated by variable brightness LED's. Gives a high resolution picture of areas that are difficult to see with the naked eye - i.e. inside of diesel cylinder chambers as it can be inserted through the glowplug hole, vehicle door spaces, corrosion checks and many other uses in the automotive, building and maintenance industries. Features full video motion recording and still photograph capture onto standard SD-HC memory card (supplied separately). Built-in microphone/speaker and flexible handle with stops at 0°, 45° and 80°. Complete with USB cable and phono TV connection (RCA) lead. Powered by four AA batteries (supplied separately). Display packed.

| Stock No. | Description | Box Qty | Price each |
|-----------|--------------------|---------|------------|
| 05163 | Camera | - | €393.30P |
| 61834 | Batteries (4 x AA) | - | €4.38D |

3 CAM5

Flexi Inspection Camera with PAL Video Out Connection and 10mm dia. Camera Probe

State-of-the-art camera with a 2.4" TFT LCD colour viewing screen and 1M flexible probe with a 10mm diameter camera head illuminated by six high power LED's. Gives a high resolution picture of areas that are difficult to see with the naked eye - i.e. inside of cylinder chambers, vehicle door spaces, corrosion checks and many other uses in the automotive workshop. Features a PAL video-out connection cables allows real-time viewing or video recording. Powered by four AA batteries (supplied separately). Display packed.

| Stock No. | Description | Box Qty | Price each |
|-----------|--------------------|---------|------------|
| 13828 | Camera | - | €227.90P |
| 61834 | Batteries (4 x AA) | - | €4.38D |

10mm dia. water resistant camera head illuminated by six high power LEDs.



Picture (right) shows camera in use at the aircraft conservation unit of the Fleet Air Arm Museum, Somerset.

1M flexible lead for access to areas impossible to reach by conventional means.

High resolution 2.4" TFT LCD colour screen allows a clear and precise view of the workpiece



BOX QUANTITY INFORMATION

FOR YOUR CONVENIENCE, WE RECOMMEND ORDERING IN BOX QUANTITY OR MULTIPLES OF BOX QUANTITY WHERE SHOWN. YOU CAN STILL ORDER IN ANY QUANTITY UNLESS SPECIFICALLY STATED OTHERWISE



The Draper Expert Quality Range of automotive socketry covers most automotive vehicle applications as shown in the tables below.

Contact the Draper Sales Desk on +44 (0)23 8049 4333 if your particular vehicle application is not shown.



Specialist Automotive Sockets

Expert Quality selection of specialist automotive sockets suitable for a variety of maintenance tasks on cars or light commercial vehicles. Each socket is manufactured from Chrome Vanadium or Molybdenum, as appropriate for the designed task. While every effort has been made to ensure the information is correct always refer to the user manual for confirmation of the socket required.



| Stock No. | Part No. | Size | Sq. Drive | Description | Used on these vehicles | Box Qty | Price each | |
|-----------|----------|---------|--------------|-------------|------------------------|---|------------|---------|
| 1 | 55540 | DT-OXY | 22mm | 3/8" | Oxygen Sensor Socket | GM, Mitsubishi, Nissan, VW | — | €13.60D |
| 2 | 39046 | HTD-MM | 22mm | 1/2" | Diesel Injector Socket | GM, Mitsubishi, Nissan, VW | — | €11.80D |
| 3 | 16216 | HTD-MM | 27mm | 1/2" | Diesel Injector Socket | Ford, Mercedes, Nissan, Opel, Peugeot, Toyota, Volvo, VW/Audi | — | €14.25D |
| 4 | 21833 | HTD-MM | 28mm | 1/2" | Diesel Injector Socket | Scania, Volvo | — | €16.45D |
| 5 | 22192 | HTD-MM | 30mm | 1/2" | Hub Nut Socket | Audi, Fiat, Ford, GM, PSA, Renault, VW | — | €15.60D |
| 6 | 35521 | HTD-MM | 32mm | 1/2" | Hub Nut Socket | Audi, Fiat, Ford, GM, PSA, Renault, VW | — | €13.93D |
| 7 | 39047 | HTD-MM | 35mm | 1/2" | Hub Nut Socket | Citroën, Peugeot | — | €16.08D |
| 8 | 26916 | HTD-AF | 1.1/2"(38mm) | 1/2" | Hub Nut Socket | Rover | — | €25.83D |
| 9 | 71883 | 419D-MM | 24mm | 3/4" | Hub Nut Impact Socket | Ford, Mercedes | — | €24.65D |
| 10 | 71392 | 410D-MM | 26mm | 1/2" | Hub Nut Impact Socket | VW Group | — | €10.88D |
| 11 | 71908 | 419D-MM | 27mm | 3/4" | Hub Nut Impact Socket | DAF, Fiat Iveco, Renault, Volvo, VW | — | €26.08D |
| 12 | 05060 | 419D-MM | 28mm | 3/4" | Hub Nut Impact Socket | ERF, Leyland | — | €26.68D |
| 13 | 71393 | 410D-MM | 30mm | 1/2" | Hub Nut Impact Socket | Audi, VW | — | €13.08D |
| 14 | 71916 | 419D-MM | 30mm | 3/4" | Hub Nut Impact Socket | Bedford, Scammel | — | €27.83D |
| 15 | 71924 | 419D-MM | 32mm | 3/4" | Hub Nut Impact Socket | Mercedes | — | €27.83D |
| 16 | 11899 | 411D-MM | 33mm | 3/4" | Hub Nut Impact Socket | Bedford, Leyland, Scammel, Volvo | — | €28.88D |
| 17 | 71940 | 419D-MM | 36mm | 3/4" | Hub Nut Impact Socket | Alfa Romeo, Fiat, GM, Lancia, PSA, SAAB, VW, Volvo | — | €32.33D |
| 18 | 26669 | TTD-MM | 41mm | 3/4" | Hub Nut Impact Socket | Alfa Romeo, Citroën, Fiat, Ford | — | €20.08D |
| 19 | 05027 | 419MM | 45mm | 3/4" | Hub Nut Impact Socket | BMW | — | €30.58D |
| 20 | 36639 | DSSA | 45mm | 3/4" | Drive Shaft Socket | Audi | — | €39.94D |
| 21 | 05028 | 419-MM | 46mm | 3/4" | Hub Nut Impact Socket | BMW | — | €31.68D |
| 22 | 33319 | 411D-MM | 50mm | 3/4" | Hub Nut Impact Socket | Ford | — | €22.44D |
| 23 | 39048 | TTD-MM | 56mm | 3/4" | Hub Nut Impact Socket | Ford | — | €29.80D |
| 24 | 39049 | TTD-MM | 65mm | 3/4" | Hub Nut Impact Socket | Ford | — | €30.28D |

AUTOMOTIVE SPECIALISED SOCKETRY

NEW

DRAPER Expert

1/2" SQ.DRIVE

"Draper Expert HI-TORQ"
6 point

STOCKIST INFO
REVISED DEALER CODE APPLIES TO THIS ITEM



1 AWNSS/3A

1/2" Sq. Dr. Draper Expert HI-TORQ® Wheel Nut Sockets for Alloy Wheels

Expert Quality, set of three 6 point Draper Expert HI-TORQ® sockets sizes 17, 19 and 21mm. Manufactured from chrome molybdenum. Fitted with internal and external nylon sleeve preventing damage to wheels and nuts when in use. Supplied in handy case.

Draper Expert HI-TORQ® is a registered trademark of Draper Tools Ltd.

| Stock No. | Box Qty | Price per set |
|-----------|---------|---------------|
| 30630 | - | €32.76H |



SPECIAL FLUTES LOCK ON TO DAMAGED WHEEL NUTS



DRAPER Expert

STOCKIST INFO
REVISED DEALER CODE APPLIES TO THIS ITEM



6 409/4BNR

4 piece 1/2" Sq. Dr. Wheel Nut and Bolt Remover Set

Expert Quality, for the removal of damaged, painted over, rounded off and rusted bolts. Special flutes lock on to the workpiece for easy removal. Manufactured from chrome molybdenum steel hardened and tempered with chemically blacked finish. Packed in blow mould case with display sleeve.

Contents: 17, 19, 21 and 22mm

| Stock No. | Box Qty | Price per set |
|-----------|---------|---------------|
| 05726 | - | €32.94H |

1/2" SQ.DRIVE

NEW

DRAPER Expert

1/2" SQ.DRIVE

"Draper Expert HI-TORQ"
6 point

2 AWN/17MM

17mm 1/2" Sq. Dr. Draper Expert HI-TORQ® Wheel Nut Socket for Alloy Wheels

Expert Quality, 6 point Draper Expert HI-TORQ® 17mm socket. Manufactured from chrome molybdenum. Sleeved with nylon internally and externally preventing damage to wheels and nuts when used. Display packed.

Draper Expert HI-TORQ® is a registered trademark of Draper Tools Ltd.

| Stock No. | Box Qty | Price each |
|-----------|---------|------------|
| 30631 | - | €13.74D |



NEW

DRAPER Expert

1/2" SQ.DRIVE

"Draper Expert HI-TORQ"
6 point

4 AWN/21MM

21mm 1/2" Sq. Dr. Draper Expert HI-TORQ® Wheel Nut Socket for Alloy Wheels

Expert Quality, 6 point Draper Expert HI-TORQ® 21mm socket. Manufactured from chrome molybdenum. Sleeved with nylon internally and externally preventing damage to wheels and nuts when used. Display packed.

Draper Expert HI-TORQ® is a registered trademark of Draper Tools Ltd.

| Stock No. | Box Qty | Price each |
|-----------|---------|------------|
| 30640 | - | €14.69D |



NEW

DRAPER Expert

STOCKIST INFO
REVISED DEALER CODE APPLIES TO THIS ITEM



7 LWNS4-B

4 piece 1/2" Sq. Dr. Locking Wheel Nut Set

Expert Quality, for the installation and removal of locking wheel nuts on most vehicles (except those fitted with rotating protector shrouds). Manufactured from molybdenum steel, hardened, tempered and chemically blacked for corrosion protection. Reduced tapered internal left hand coarse thread. For use with air and electric tools. Supplied with metal case. Display packed.

Contents: 38mm long x 17.0, 18.5, 21.5 and 26.0mm (open end)

| Stock No. | Box Qty | Price per set |
|-----------|---------|---------------|
| 34032 | - | €35.23H |

1/2" SQ.DRIVE

NEW

DRAPER Expert

1/2" SQ.DRIVE

"Draper Expert HI-TORQ"
6 point

3 AWN/19MM

19mm 1/2" Sq. Dr. Draper Expert HI-TORQ® Wheel Nut Socket for Alloy Wheels

Expert Quality, 6 point Draper Expert HI-TORQ® 19mm socket. Manufactured from chrome molybdenum. Sleeved with nylon internally and externally preventing damage to wheels and nuts when used. Display packed.

Draper Expert HI-TORQ® is a registered trademark of Draper Tools Ltd.

| Stock No. | Box Qty | Price each |
|-----------|---------|------------|
| 30638 | - | €13.74D |



NEW

DRAPER Expert

1/2" SQ.DRIVE

"Draper Expert HI-TORQ"
6 point

5 AWN/22MM

22mm 1/2" Sq. Dr. Draper Expert HI-TORQ® Wheel Nut Socket for Alloy Wheels

Expert Quality, 6 point Draper Expert HI-TORQ® 22mm socket. Manufactured from chrome molybdenum. Sleeved with nylon internally and externally preventing damage to wheels and nuts when used. Display packed.

Draper Expert HI-TORQ® is a registered trademark of Draper Tools Ltd.

| Stock No. | Box Qty | Price each |
|-----------|---------|------------|
| 30646 | - | €14.69D |



IMPACT WRENCHES

An extensive range of 1/4", 3/8", 1/2" and 1" impact wrenches are shown in section 11, pages 561-563.



BOX QUANTITY INFORMATION

FOR YOUR CONVENIENCE, WE RECOMMEND ORDERING IN BOX QUANTITY OR MULTIPLES OF BOX QUANTITY WHERE SHOWN. YOU CAN STILL ORDER IN ANY QUANTITY UNLESS SPECIFICALLY STATED OTHERWISE

STOCKIST INFO
REVISED DEALER
CODES APPLY TO
ITEMS 1, 2 & 3
ON THIS PAGE

DRAPER Expert

1/2"
SQ.DRIVE



1 LWN/DS4

4 piece 1/2" Sq. Dr. Wheel Nut Double Impact Socket Kit

Expert Quality, three double-ended impact sockets size 17, 19 and 21mm. One end is hexagon 6pt and the other a reverse conical gripper thread for the removal of locking wheel nuts. Supplied with a 1/2" sq. dr. 75mm impact extension bar. Packed in a nylon wallet with hook and loop closure in display carton.

These kits should only be sold to bona fide garages and emergency service organisations.

| Stock No. | Box Qty | Price per kit |
|-----------|---------|---------------|
| 09539 | - | €64.95H |



DRAPER Expert

3/8"
SQ.DRIVE

1/2"
SQ.DRIVE



2 LSS7

7 piece 3/8, 1/2" Sq. Dr. 'Lambda' or Oxygen Sensor Socket Set

Expert Quality, for removal, inspection or replacement of heated and non-heated oxygen sensors fitted to the following vehicle marques; Audi, BMW, Citroën, Mercedes, Peugeot, Renault, Skoda, GM (Vauxhall/Opel) and Volkswagen. Cut-away sections allow some sockets to fit over wiring harnesses. Sockets have black phosphate finish. Display packed in blow moulded case. Contents:

3/8" Square Drive

- 3/8" x 80mm deep socket with 7.7mm wide long groove
- 3/8" x 90mm deep socket with 20.5mm wide long groove
- Offset square drive socket with 8.6mm wide full length groove
- 1.1/16" x 74mm deep socket

1/2" Square Drive

- Offset square drive deep socket 22 x 49.5mm with 11mm wide full length groove
- 27 x 85mm deep socket with large side viewing window
- 29 x 90mm deep socket with 8.2mm wide long groove

| Stock No. | Box Qty | Price per set |
|-----------|---------|---------------|
| 89765 | - | €74.13H |

DRAPER Expert

1/2"
SQ.DRIVE



3 DIS4-2

4 piece 1/2" Sq. Dr. Diesel Injector Socket Set

Expert Quality, chrome molybdenum steel hardened and tempered with black phosphate finish and side viewing windows. Suitable for diesel injectors fitted to Alfa Romeo, Audi, BMW, Chrysler, Ford, GM (Vauxhall/Opel), Mercedes, Rover, Seat, Volkswagen and Volvo engines. Also suitable for MAN 2.5TD and Scania heavy goods vehicles Packed in blow mould storage case with display sleeve. Contents: • 22mm x 110mm long hexagon socket • 22mm x 80mm long bi-hexagon socket • 27mm x 78mm long bi-hexagon socket • 28mm x 80mm long bi-hexagon socket

| Stock No. | Box Qty | Price per set |
|-----------|---------|---------------|
| 27437 | - | €50.74H |

DAVE SAYS

In the manufacture of steel for tools, the correct amount of carbon added in the smelting process is critical.

Tools that require force to be applied, like impact sockets, also need a lower carbon content in their steel making the tools more pliable. An example of this is pry bars; nobody wants a pry bar to snap when in use, so it's manufactured with less carbon allowing it to bend before it snaps. Precision tools require the opposite, this is why you'll find parts in torque wrenches are made with a higher carbon content in the steel; you don't want them bending, as this would achieve inaccurate readings. You can be sure all Draper tools are manufactured correctly.



QUALITY MAKES THE DIFFERENCE

NEW

DRAPER Expert



4 DSSA

45mm 3/4" Sq. Dr. Audi Drive Shaft Socket

3/4"
SQ.DRIVE

Expert Quality, 12 point Bi-Hex low profile socket used for the drive shaft nuts on 6 speed (4wd) Audi gearboxes. Manufactured from chrome vanadium steel. Display packed.

| Stock No. | Box Qty | Price each |
|-----------|---------|------------|
| 36639 | - | €39.94D |

NEW

DRAPER Expert



5 SP250

3/8" Sq. Dr. 8mm Thread (14mm Socket) 250mm Magnetic Spark Plug Socket

3/8"
SQ.DRIVE

Expert Quality ideal for deep-seated spark plugs with a magnetic end for easy and safe retrieval of spark plugs. 12 point, Bi-Hex socket forged from chrome vanadium steel, hardened, tempered and chrome plated. Suitable for a range of models which use 8mm thread/14mm socket 12 point spark plugs including Citroen, Peugeot, Renault and the BMW Mini One. Display packed.

| Stock No. | Thread Size | Socket Size | Box Qty | Price each |
|-----------|-------------|-------------|---------|------------|
| 28880 | 8mm | 14mm | - | €20.63D |

SPARK PLUG SOCKETS

3/8" and 1/2" sq. drive are shown on pages 31 and 36.





1 1402

Spark Plug Wrenches

Swivel wrenches with plastic coated T handle. Socket forged steel hardened, tempered and chrome plated with rubber insert for spark plug insulator protection and retention. Display packed.

| Stock No. | Plug Size | Box Qty | Price each |
|-----------|-----------|---------|------------|
| 13867 | 10mm | 6 | €8.53D |
| 13868 | 14mm | 6 | €8.53D |

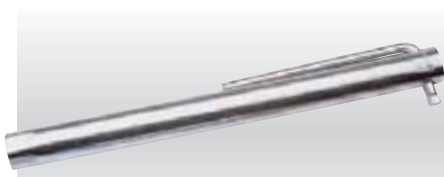

2 1401

300mm Long Reach Spark Plug Wrenches

A tubular carbon steel zinc plated wrench, designed for use with spark plugs which are deep set into engine blocks. Socket end has rubber insert for spark plug insulator protection and retention. Supplied with integral tommy bar. Display packed.

| Stock No. | Plug Size | Box Qty | Price each |
|-----------|-----------|---------|------------|
| 12242 | 10mm | 6 | €7.25D |
| 12243 | 14mm | 6 | €7.25D |



3

Spark Plug Wrenches

Plated steel box end wrenches with swivel handle and zinc plated finish. Display packed.

| Stock No. | Part No. | Plug Size | Box Qty | Price each |
|-----------|----------|-----------|---------|------------|
| 07111 | S154 | 10mm | 6 | €4.73D |
| 07129 | S155 | 14mm | 6 | €5.13D |

4 4862

Spark Plug Cleaning Brush

Compact brush with dense brass fill in wooden stock. Ideal for electrical terminals and spark plug cleaning. Display packed.

| Stock No. | Box Qty | Price each |
|-----------|---------|------------|
| 13157 | 6 | €2.83D |



5 BNB

175mm Brass and Nylon Wire brush

Expert Quality, double sided brush with three rows of brass wire and nylon fill. Plastic handle has inbuilt scraper on tip. Ideal for electrical terminals and spark plug cleaning. Display packed.

| Stock No. | Box Qty | Price each |
|-----------|---------|------------|
| 26318 | - | €4.08D |



6 COPP/VW

VW Coil-on-Plug Puller

Expert Quality, for hooking under the ignition coil pack for easy removal. Suitable for use on VW Polo/Golf 1.4L, Caddy 1.4L, Beetle 1.4L, Passat, Touran 1.6L, Phaeton, Transporter, Lupo 4 cylinder and AZD engines. Display packed.

| Stock No. | Box Qty | Price each |
|-----------|---------|------------|
| 23254 | - | €20.45D |



7 GPRK

3 piece Glow Plug Reamer Kit

Expert Quality, designed to clean and clear combustion channel into cylinder before the refitting of original or fitting of new diesel glow plugs. Chrome molybdenum with titanium coating for enhanced performance. Sizes: M10 x 1.0, M12 x 1.25 short and M12 x 1.25 long. Display packed.

| Stock No. | Box Qty | Price per kit |
|-----------|---------|---------------|
| 23240 | - | €54.03P |



8 DISC6

6 piece Diesel Injector Seat Cutter Set

Expert Quality, for cleaning and re-cutting of diesel injector seats in cylinder head. Display packed in blow mould case with EVA foam insert.

Contents: • T bar handle assembly • pilot guide
• 4 reamers to suit most popular vehicles/injector makes

| Stock No. | Box Qty | Price per set |
|-----------|---------|---------------|
| 30823 | - | €75.53P |

THE SPARK PLUG SIZE, I.E. 10, 12 OR 14mm REFERS TO THE THREAD DIAMETER OF THE SPARK PLUG



9 DIP3

Diesel Injector Puller

Expert Quality, for the removal of seized diesel injectors on Mercedes-Benz CDI 611, 612 and 613 engines and other manufacturers similar engines. Packed in blow mould case with display sleeve.

Contents: • 1.8kg slide hammer with 460mm shaft • Puller adaptor with M16 thread • Puller claw to grip injector

| Stock No. | Box Qty | Price each |
|-----------|---------|------------|
| 31231 | - | €94.33P |

PRODUCT INFORMATION

Every effort has been made to ensure that the applications shown in this Draper Tools Catalogue are accurate and include all the current car/van models. When using specialized automotive tools ALWAYS refer to the vehicle manufacturer's service or relevant Haynes manual for detailed and concise instruction of usage.

DRAPER Expert

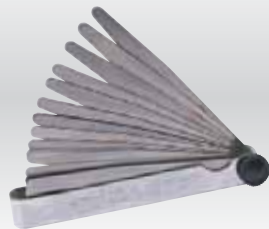

1 600C

20 Blade Metric Feeler Gauge Set

Expert Quality, 100mm long taper blades, hardened and polished for long accurate life. Each blade is marked with its size and folds into a polished steel case with thumbscrew. Display packed.

Blade sizes:

20 metric blades size: 0.05, 0.10, 0.15, 0.20, 0.25, 0.30, 0.35, 0.40, 0.45, 0.50, 0.55, 0.60, 0.65, 0.70, 0.75, 0.80, 0.85, 0.90, 0.95 and 1.0mm.

| Stock No. | Box Qty | Price per set |
|-----------|---------|---------------|
| 73996 | - | €11.15D |

NEW



4 4617B

10 Blade Metric Feeler Gauge Set

100mm long taper blades. Each blade is marked with its size and folds into a plated steel case with thumbscrew. Display packed.

Blade sizes:

Metric: 0.05, 0.10, 0.15, 0.20, 0.30, 0.40, 0.50, 0.60, 0.70, and 0.80mm

| Stock No. | Box Qty | Price per set |
|-----------|---------|---------------|
| 36169 | - | €4.33D |

6 4618

18 Blade Combination Feeler Gauge Set

Combination gauge with eight metric and ten imperial 75mm long blades hardened and polished for long accurate life. Each blade is marked with its size and folds into a plated steel case with thumbscrew. Display packed.

Blade sizes: 8 metric blades size: 0.05, 0.10, 0.15, 0.20, 0.25, 0.30, 0.40 and 0.50mm. 10 imperial blades size: 0.0015, 0.002, 0.003, 0.004, 0.006, 0.008, 0.010, 0.012, 0.015 and 0.025".

| Stock No. | Box Qty | Price per set |
|-----------|---------|---------------|
| 10094 | - | €8.33D |

DRAPER Expert



2 26F

26 Blade Imperial Feeler Gauge Set

Expert Quality, 100mm long taper blades, hardened and polished for long accurate life. Each blade is marked with its size and folds into a polished steel case with thumbscrew. Display packed.

Blade sizes:

26 imperial blades size: 0.0015, 0.002, 0.0025, 0.003, 0.004, 0.005, 0.006, 0.007, 0.008, 0.009, 0.010, 0.011, 0.012, 0.013, 0.014, 0.015, 0.016, 0.017, 0.018, 0.019, 0.020, 0.021, 0.022, 0.023, 0.024 and 0.025".

| Stock No. | Box Qty | Price per set |
|-----------|---------|---------------|
| 10286 | - | €17.53D |

NEW



5 4616B

10 Blade Imperial Feeler Gauge Set

100mm long taper blades. Each blade is marked with its size and folds into a plated steel case with thumbscrew. Display packed.

Blade sizes:

Imperial: 0.0015, 0.002, 0.003, 0.004, 0.006, 0.008, 0.010, 0.012, 0.015, 0.025"

| Stock No. | Box Qty | Price per set |
|-----------|---------|---------------|
| 36174 | - | €4.33D |

7 FG26/LR

Dual Reading Long Blade Combination Feeler Gauge Set

One piece combination gauge with 26 dual marked blades 150mm long, hardened for long accurate life. Each blade is marked with its size and folds into a case with thumbscrew. This gauge is particularly useful for use on agricultural and heavy commercial engines.

Metric - mm

0.03, 0.04, 0.05, 0.06, 0.07, 0.08, 0.09, 0.10, 0.13, 0.15, 0.18, 0.20, 0.23, 0.25, 0.28, 0.30, 0.33, 0.35, 0.38, 0.40, 0.45, 0.50, 0.60, 0.63, 0.65 and 0.70mm.

Imperial - inch

0.0012, 0.0015, 0.002, 0.0025, 0.0028, 0.003, 0.0035, 0.004, 0.005, 0.006, 0.007, 0.008, 0.009, 0.010, 0.011, 0.012, 0.013, 0.014, 0.015, 0.016, 0.018, 0.020, 0.024, 0.025, 0.026, and 0.028".

| Stock No. | Box Qty | Price per set |
|-----------|---------|---------------|
| 52339 | - | €15.43D |

DRAPER Expert



3 4620

32 Blade Dual Reading Combination Feeler Gauge Set

Expert Quality, one piece combination gauge with 32 dual marked blades 95mm long, hardened for long accurate life. Each blade is marked with its size and folds into a polished steel case with thumbscrew. Display packed.

Metric - mm

0.03, 0.04, 0.05, 0.06, 0.07, 0.08, 0.09, 0.10, 0.13, 0.15, 0.18, 0.20, 0.23, 0.25, 0.28, 0.30, 0.33, 0.35, 0.40, 0.45, 0.50, 0.55, 0.60, 0.63, 0.65, 0.70, 0.75, 0.80, 0.85, 0.90 and 1.00.

Imperial - inch

0.001, 0.0015, 0.002, 0.0025, 0.0028, 0.003, 0.0035, 0.004, 0.005, 0.006, 0.007, 0.008, 0.009, 0.010, 0.011, 0.012, 0.013, 0.014, 0.015, 0.016, 0.018, 0.020, 0.022, 0.024, 0.025, 0.026, 0.028, 0.030, 0.032, 0.034, 0.035 and 0.040".

| Stock No. | Box Qty | Price per set |
|-----------|---------|---------------|
| 19613 | - | €30.18D |



8 VTG12

12 Blade Combination Tappet Gauge Set

Combination gauge for the setting of valve tappets on motorcycles, mowers, cars, vans, etc. The dual marked blades are 95mm long and offset to give improved access to the engine and are hardened and polished for long accurate life. Each blade is marked with its size and folds into a polished steel case with thumbscrew. Display packed.

Metric - mm

0.203, 0.254, 0.305, 0.330, 0.356, 0.381, 0.406, 0.457, 0.483, 0.508, 0.635 and 0.660mm.

Imperial - inch

0.008, 0.010, 0.012, 0.013, 0.014, 0.015, 0.016, 0.018, 0.019, 0.020, 0.025, and 0.026".

| Stock No. | Box Qty | Price per set |
|-----------|---------|---------------|
| 19577 | - | €11.20D |



DRAPER Expert

1 VSC9
60-155mm Valve Spring Compressor

Expert Quality, with plastic coated locking handle. When locked on keeps valve springs positively compressed during maintenance work. Throat depth 160mm. Display packed.

| Stock No. | Box Qty | Price each |
|-----------|---------|------------|
| 02339 | - | €36.20P |

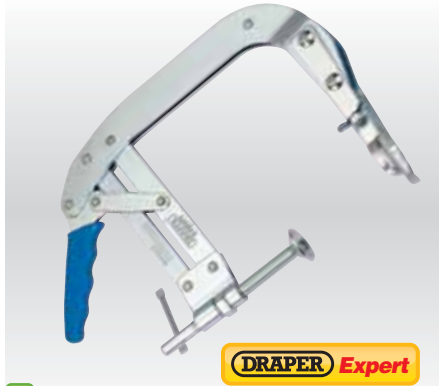

DRAPER Expert

2 VSC10
68-130mm Valve Spring Compressor

Expert Quality, with plastic coated locking handle. When locked on keeps valve springs positively compressed during maintenance work. Throat depth 160mm. Display packed.

| Stock No. | Box Qty | Price each |
|-----------|---------|------------|
| 02342 | - | €24.55P |



DRAPER Expert

3
Valve Spring Compressors

Expert Quality, with plastic coated locking handle. When locked on keeps valve springs positively compressed, double ended cap support for maximum versatility on diesel or petrol engines. Display packed.

| Stock No. | Part No. | Capacity | Throat Depth | Box Qty | Price each |
|-----------|----------|----------|--------------|---------|------------|
| 02325 | VSC6 | 35-142mm | 160mm | - | €59.50P |
| 02338 | VSC8 | 35-200mm | 250mm | - | €70.33P |



DRAPER Expert

4 VSC11
55-175mm Universal Valve Spring Compressor

Expert Quality, plastic coated locking handles to keep valve springs positively compressed during work. Suitable for use on most engines due to double-ended valve cup. Unique double action lever cams action provide choice of operation either above or below valve. Throat depth 165mm. Display packed.

| Stock No. | Box Qty | Price each |
|-----------|---------|------------|
| 02713 | - | €58.50P |



DRAPER Expert

5 VSC7
132mm Multi-Way Valve Spring Compressor

Expert Quality, variable assembly design allows use of this tool on most cylinder heads including motorcycles, small plant machinery and marine engines. Includes five valve cups, pressure winding handle and accessories. Throat depth 110mm. Packed in blow mould case with display sleeve.

| Stock No. | Box Qty | Price each |
|-----------|---------|------------|
| 30832 | - | €47.13P |

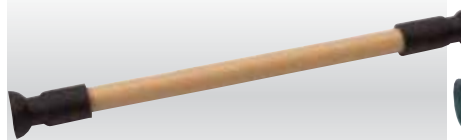

6 9902
240mm Valve Grinder

Recycled PVC shaft with 19mm and 22mm diameter rubber suction ends. Display packed.

| Stock No. | Box Qty | Price each |
|-----------|---------|------------|
| 10409 | 12 | €1.90D |



7 9902/P
Valve Grinding Kit

Recycled PVC shaft 240mm long with 19mm and 22mm diameter rubber suction ends and pots of genuine carborundum fine and coarse paste. Display packed.

| Stock No. | Box Qty | Price per kit |
|-----------|---------|---------------|
| 72891 | - | €13.73D |

PRODUCT INFORMATION

Every effort has been made to ensure that the applications shown in this Draper Tools Catalogue are accurate and include all the current car/van models. When using specialized automotive tools ALWAYS refer to the vehicle manufacturer's service or relevant Haynes manual for detailed and concise instruction of usage.

1 CH25/57

25-57mm Cylinder Hone

For use on small bore cylinders i.e. motor cycles etc. with capacities between 25 and 57mm. The flexible drive shaft allows easy alignment whilst working, with the honing pressure adjustable to suit the particular application. Suitable for use with an electric or air drill, the maximum working speed is 2400r/min. Overall length 210mm. Supplied with 220 grit stone set, which are also available separately - Stock No. 56247. Display packed.

| Stock No. | Description | Box Qty | Price each |
|-----------|--------------------|---------|------------|
| 56244 | Cylinder Hone | - | €16.85D |
| 56247 | Stone Set 220 grit | - | €8.83D |

2 CH51/177

51-177mm Cylinder Hone

For use on cylinders with capacities between 51 and 177mm i.e. cars, vans, trucks, marine and industrial applications. The flexible drive shaft allows easy alignment whilst working, with the honing pressure adjustable to suit the particular application. Suitable for use with an electric or air drill, the maximum working speed is 2400r/min. Supplied with 180 grit stone set, which is also available separately as are other grades. Overall length 300mm. Display packed.

| Stock No. | Description | Box Qty | Price each |
|-----------|----------------------|---------|------------|
| 56246 | Cylinder Hone | - | €46.70D |
| 56248 | Stone Set - 280 grit | - | €20.13D |
| 56249 | Stone Set - 180 grit | - | €20.13D |
| 56250 | Stone Set - 120 grit | - | €20.13D |



3 PRC

Piston Ring Compressors

Spring steel with steel adjusting key. Display packed.

| Stock No. | Capacity | Depth | Box Qty | Price each |
|-----------|----------|-------|---------|------------|
| 51844 | 45-75mm | 50mm | - | €17.28D |
| 51845 | 60-100mm | 75mm | - | €22.78D |
| 51846 | 75-140mm | 75mm | - | €27.38D |
| 51847 | 70-150mm | 100mm | - | €28.40D |



5 373

GM (Vauxhall/Opel) Valve Play Compensator and Rocker Arm Remover

Expert Quality, allows easy removal of the rocker arm and valve play compensator (hydraulic tappets) on GM (Vauxhall/Opel) OHC engines without the need to remove the camshaft. Display packed.

| Stock No. | Box Qty | Price each |
|-----------|---------|------------|
| 33607 | 2 | €27.35D |

4 CHS2

2 piece Cylinder Head Stand Kit

Expert Quality, securely supports cylinder heads for most forms of service and repair applications. Heavy duty mild steel with zinc plated finish. Display packed.

| Stock No. | Box Qty | Price per kit |
|-----------|---------|---------------|
| 89767 | - | €38.28D |



DRAPER Expert



DRAPER Expert

6 PBHIW

1/2" Sq Dr Powerbar Hand Impact Wrench

Expert Quality, high strength tempered steel powerbar wrench ideal for removing pulleys and flywheels when conventional ratcheting wrenches are unable to gain access. Display packed.

| Stock No. | Length | Box Qty | Price each |
|-----------|--------|---------|------------|
| 24439 | 620mm | - | €68.18P |

1/2" SQ. DRIVE



1 EABT-1

DRAPER Expert

2 piece Stretch Drive Belt Tool Kit

Expert Quality, auxiliary belt tool for removal or installation of stretch type belts. Comprises a removal tool and separate installation tool. Compatible with most vehicles. Display packed in blow mould storage case.

| Stock No. | Box Qty | Price per kit |
|-----------|---------|---------------|
| 12893 | - | €91.08D |



2 SBSK15

DRAPER Expert

15 piece Serpentine Belt Service Kit

Expert Quality, for the removal and maintenance of polyrib serpentine belts used on engine drive systems. This kit is designed to tackle the restricted working space encountered when in this area of the engine compartment. Kit comprises a tensioner wrench with 25mm female ratchet drive, belt remover/installer plus eight sockets, 3/8" and 1/2" sq. drive adaptors. Display packed in blow mould case. Contents: • 230mm Tensioner wrench with 25mm female ratchet drive one end and 3/8" sq. dr. the other • Belt remover/installer 410mm long with soft grip handle • 8 sockets size: 8, 12, 13, 14, 17, 18, 19mm and 5/8" • 2 square drive adaptors: 3/8" and 1/2" • 3 double-ended hexagon adaptors size: 8/6mm x 63mm, 8 x 10mm x 63mm and 8 x 25mm

| Stock No. | Box Qty | Price per kit |
|-----------|---------|---------------|
| 40446 | - | €99.65D |



3 WSE

DRAPER Expert

600mm Precision Straight Edge

Expert Quality, ideal for checking distortion on cylinder heads and engine blocks. Manufactured from high grade steel, ground and polished to a surface tolerance of 0.06mm. Packed in blow mould case with display sleeve.

| Stock No. | Box Qty | Price each |
|-----------|---------|------------|
| 22484 | - | €175.95D |



4 BBS

DRAPER Expert

20 piece Wire Brush Set

Expert Quality, suitable for a variety of uses including internal/external thread cleaning, cleaning drilled holes and cleaning small bore holes etc. Set comprises six nylon brushes, six stainless steel brushes, six brass brushes, soft grip magnetic handle and a 150mm magnetic extension. Supplied with canvas fold up case. Display packed.

Contents:

- 6 x nylon, brass and steel brushes: 9, 11, 13, 15, 17, 19mm dia.
- 150mm extension

| Stock No. | Box Qty | Price per set |
|-----------|---------|---------------|
| 22232 | - | €45.00D |



5 THS/M

DRAPER Expert

T-Handle Metric Socket Wrenches

Expert Quality, with sockets manufactured from chrome vanadium steel hardened and tempered with carbon steel PVC dipped handles. Display packed.

| Stock No. | Size | Box Qty | Price each |
|-----------|------|---------|------------|
| 72791 | 8mm | - | €12.33D |
| 72792 | 10mm | - | €12.58D |
| 72793 | 12mm | - | €13.23D |
| 72794 | 13mm | - | €13.48D |
| 72795 | 14mm | - | €13.73D |
| 72796 | 17mm | - | €16.00D |

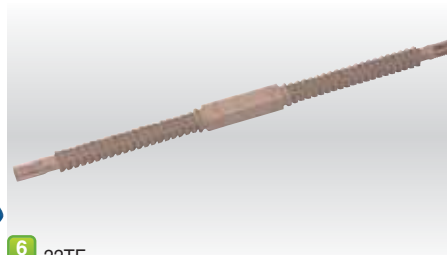

6 22TF

Metric Thread Restoring File

For restoring and cleaning internal or external threads. Thread pitch: 080-100, 175-200, 125-150 and 250-300. Packed in clear plastic tube.

| Stock No. | Box Qty | Price each |
|-----------|---------|------------|
| 68703 | - | €53.60D |

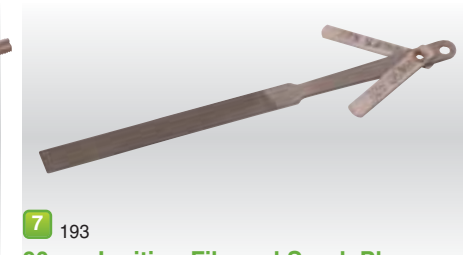

7 193

90mm Ignition File and Spark Plug Gauge

File with points and spark plug gauges fitted with thicknesses of 0.381mm (0.015") and 0.625mm (0.025") respectively. Display packed.

| Stock No. | Box Qty | Price each |
|-----------|---------|------------|
| 33554 | - | €3.85D |

PRODUCT INFORMATION

Every effort has been made to ensure that the applications shown in this Draper Tools Catalogue are accurate and include all the current car/van models. When using specialized automotive tools ALWAYS refer to the vehicle manufacturer's service or relevant Haynes manual for detailed and concise instruction of usage.

1

Nut Splitters

For the safe removal of corroded or damaged nuts without damaging bolt threads. Forged medium carbon steel frame with enclosed head and chrome plated finish. Threaded splitting pin with ground cutter manufactured from chrome molybdenum steel, hardened and tempered. Display packed.

| Stock No. | Part No. | Capacity | Length | Box Qty | Price each |
|-----------|----------|----------|--------|---------|------------|
| 10913 | NC912 | 9-12mm | 80mm | 6 | €11.08D |
| 10915 | NC1216 | 12-16mm | 105mm | 6 | €12.53D |
| 10916 | NC1622 | 16-22mm | 130mm | 6 | €16.45D |



2 NC922

3 piece Nut Splitter Set

For the safe removal of corroded or damaged nuts without damaging bolt threads. Drop forged steel body hardened and tempered with plated finish. Threaded splitting pin manufactured from chrome molybdenum steel hardened and tempered with chemically blacked finish. Capacities: 9 - 12mm, 12 - 16mm and 16 - 22mm. Display packed.

| Stock No. | Box Qty | Price per set |
|-----------|---------|---------------|
| 55108 | 6 | €38.38D |



DRAPER Expert



3 EXTC

280mm Exhaust Pipe Cutter

Expert Quality, for cutting thin walled exhaust pipes 35-64mm diameter, up to 3mm thickness. The complete cut can be made in just a quarter of a turn making this tool ideal for working in confined spaces under vehicles. Display packed.

| Stock No. | Box Qty | Price each |
|-----------|---------|------------|
| 40100 | - | €57.10D |

4 178A

Gasket Scraper

Manufactured from carbon steel hardened, tempered and satin chrome finish with shot blast scraper end. For cleaning cylinder heads, removing old sealants and carbon, etc. Display packed.

| Stock No. | Box Qty | Price each |
|-----------|---------|------------|
| 36923 | 12 | €10.98D |



5 5SR SET

5 piece Scraper and Remover Set

Suitable for a variety of applications including removing cotter pins, radiator hoses, flaking paint and gaskets. Blades hardened and tempered carbon steel. Display packed.

- Contents:
- 2 Multi-purpose scrapers - 210 and 275mm
 - Scratch awl - 200mm • Cotter pin puller - 225mm
 - Radiator hose remover - 175mm

| Stock No. | Box Qty | Price per set |
|-----------|---------|---------------|
| 35100 | 6 | €37.25D |

DRAPER Expert



6 SSS3

3 piece Stainless Steel Scraper Set

Expert Quality, 1.5mm thick stainless steel blades with lacquered wood handles. Display packed in wallet.

- Contents: scrapers 10 x 165mm; 15 x 170mm and 22 x 175mm long

| Stock No. | Box Qty | Price per set |
|-----------|---------|---------------|
| 30824 | - | €31.35D |

7 ORP2

O Ring and Seal Puller

Universal seal puller for use on rubber 'O' rings, oil and grease seals. Particularly useful on commercial vehicle applications. Display packed.

| Stock No. | Length | Box Qty | Price each |
|-----------|--------|---------|------------|
| 37439 | 325mm | 6 | €11.33D |

MINI HOOK & PICK SET

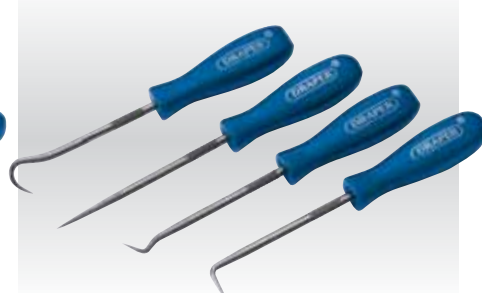

8 MPH SET

4 piece Mini Hook and Pick Set

Designed to ease the removal of 'O' rings, split pins, seals and bushes in various automotive and engineering applications. Blades stainless steel hardened and tempered with impact - resistant handles. Display packed.

- Contents: Awl, Clevis - pin remover, 'L' and 'V' hooks

| Stock No. | Box Qty | Price per set |
|-----------|---------|---------------|
| 35099 | 4 | €15.00D |

DRAPER Expert



9 OSP3

3 piece O-Ring and Seal Puller Kit

Expert Quality, for use in the automotive or engineering workshop. Satin chrome plated shafts. Display packed.

- Contents:

- 150mm long needle tip o-ring pick
- 115mm T-handle seal pick and puller
- 165mm T-handle seal pick and puller

| Stock No. | Box Qty | Price per kit |
|-----------|---------|---------------|
| 24772 | - | €27.90D |

1 SRIK

Oil Seal Removal and Installation Kit

Expert Quality, allows simple removal and replacement of oil seals preventing unnecessary and time-consuming dismantling of engines. Comprises of 19 popular-sized adaptors and compatible seal puller. Packed in blow mould case with display sleeve.

| Stock No. | Box Qty | Price per kit |
|-----------|---------|---------------|
| 04582 | - | €104.90P |



DRAPER Expert



2 PB/SET/SG3

3 piece Soft Grip Pry Bar Set

Expert Quality, chemically blacked finish blades with striking caps and impact-resistant soft grip handles. Display packed. Contents: 300, 450 and 600mm long

| Stock No. | Box Qty | Price per set |
|-----------|---------|---------------|
| 88636 | 4 | €64.98D |

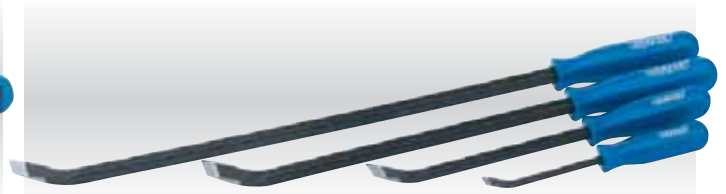

3 PB/SET

4 piece Pry Bar Set

Chemically blacked finish blades with PVC handles. Display packed. Contents: 200, 300, 450 and 600mm long

| Stock No. | Box Qty | Price per set |
|-----------|---------|---------------|
| 35396 | - | €35.90D |

NEW



4 MPT/B

Magnetic Parts Bowl

For storage of nuts, bolts, screws, etc. whilst working. Bowl has rubber covered magnetic base for affixing to metal objects such as tool boxes etc. Magnetism transfers to inner surface of bowl to retain small metal parts, nuts, bolts, etc. Sold loose.

| Stock No. | Diameter | Box Qty | Price each |
|-----------|----------|---------|------------|
| 34183 | 145mm | 6 | €11.80D |

NEW



5 MPT/2/B

Large Magnetic Parts Tray

For storage of nuts, bolts, screws, etc. whilst working. Tray has magnetic base for affixing to metal objects such as tool chests etc. Magnetism transfers to inner surface of tray to retain small metal parts, nuts, bolts, etc. Sold loose.

| Stock No. | Dimensions | Box Qty | Price each |
|-----------|-------------|---------|------------|
| 34184 | 230 x 140mm | 6 | €14.83D |

NEW



6 MPT4B

Stainless Steel Magnetic Parts Tray

Useful when working with nuts, bolts, screws, etc. Tray has magnetic base for attaching to metal objects such as tool boxes etc. Magnetism transfers to inner surface of tray to retain small metal parts, nuts, bolts, etc. Display packed.

| Stock No. | Dimensions | Box Qty | Price each |
|-----------|-------------|---------|------------|
| 33007 | 360 x 160mm | 6 | €24.98D |



7 MPT13

Magnetic Holder for Glove/Tissue Boxes

For storage of standard size boxes of latex gloves or tissues up to 145mm wide. Holder has rubber protected magnetic back for affixing to vertical metal objects such as tool boxes etc. Optional hanging holes for fixing in permanent locations. Display packed.

| Stock No. | Box Qty | Price each |
|-----------|---------|------------|
| 78665 | - | €38.83D |



8 MPT12

Magnetic Holder

For attaching to the side of metal objects using powerful magnets. 50mm diameter. Hook and loop straps for holding different sized tools. Display packed.

| Stock No. | Box Qty | Price each |
|-----------|---------|------------|
| 72845 | - | €13.93D |



9 MPM4/4

4 piece Telescopic Pick Up Tool and Mirror Set

Handle with 500mm extendable shaft. Screw-in end allows magnet or mirror to be attached. Two attachments with 50mm and 30mm diameter mirrors and 50mm long magnet. Packed in plastic storage case and display packed.

| Stock No. | Box Qty | Price per set |
|-----------|---------|---------------|
| 44001 | - | €22.05D |

BOX QUANTITY INFORMATION

FOR YOUR CONVENIENCE, WE RECOMMEND ORDERING IN BOX QUANTITY OR MULTIPLES OF BOX QUANTITY WHERE SHOWN. YOU CAN STILL ORDER IN ANY QUANTITY UNLESS SPECIFICALLY STATED OTHERWISE

CLOSE UP OF MAGNETIC PICK-UP HEADS FOR ITEM Nos. 1-4.

To help you select which type of magnetic pick-up head is suitable for your application.



Stock No. 52305



Stock No. 66198



Stock No. 22213



Stock No. 10195

1 5361

560mm Flexible Magnetic Pick-Up Tool

Expert Quality, chrome plated flexible shaft with plastic handle and removable protective cap over magnet. Display packed.

| Stock No. | Box Qty | Price each |
|-----------|---------|------------|
| 52305 | 4 | €18.20D |

2 5362

540mm High Power Flexible Magnetic Pick-Up Tool

Expert Quality, chrome plated flexible shaft with plastic handle. Will lift approximately 1.5kg. Display packed.

| Stock No. | Box Qty | Price each |
|-----------|---------|------------|
| 66198 | 4 | €24.83D |

3 5360A

95-470mm Telescopic Magnetic Pick-Up Tool

A fully extendable pick up tool with magnetic end. Ideal for the retrieval of nuts, screws and objects lost in remote places. Display packed.

| Stock No. | Box Qty | Price each |
|-----------|---------|------------|
| 22213 | 6 | €8.68D |

4 5355

610mm Magnetic Pick-Up Tool

Fully flexible plated stem with plastic grip and powerful magnetic end. Display packed.

| Stock No. | Box Qty | Price each |
|-----------|---------|------------|
| 10195 | 6 | €4.25D |

5 5350

610mm Pick-Up Tool

Fully flexible plated stem with claw action pick-up end, controlled from spring-loaded grip. Display packed.

| Stock No. | Box Qty | Price each |
|-----------|---------|------------|
| 39669 | 6 | €7.05D |

6 M301

370mm Fixed Shaft Inspection Mirror

Fully flexible head with mirror 55mm diameter to give good visibility in concealed areas. Plated finish with plastic grip. Display packed.

| Stock No. | Box Qty | Price each |
|-----------|---------|------------|
| 10263 | 4 | €13.05D |

7 M302

470mm Flexible Shaft Inspection Mirror

Fully flexible shaft and fixed head with mirror 55mm diameter to give good visibility in concealed areas. Plated finish with plastic grip. Display packed.

| Stock No. | Box Qty | Price each |
|-----------|---------|------------|
| 11954 | 4 | €13.48D |

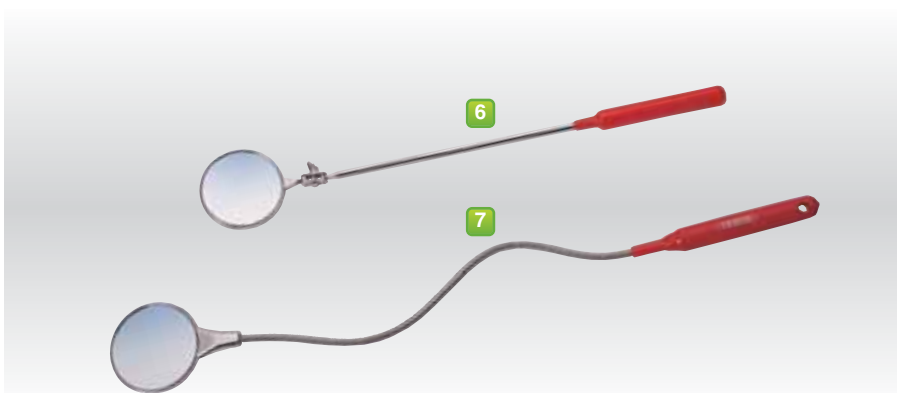
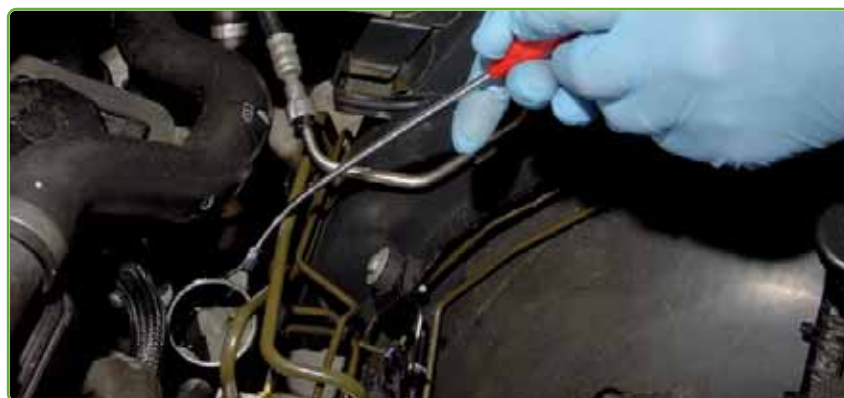
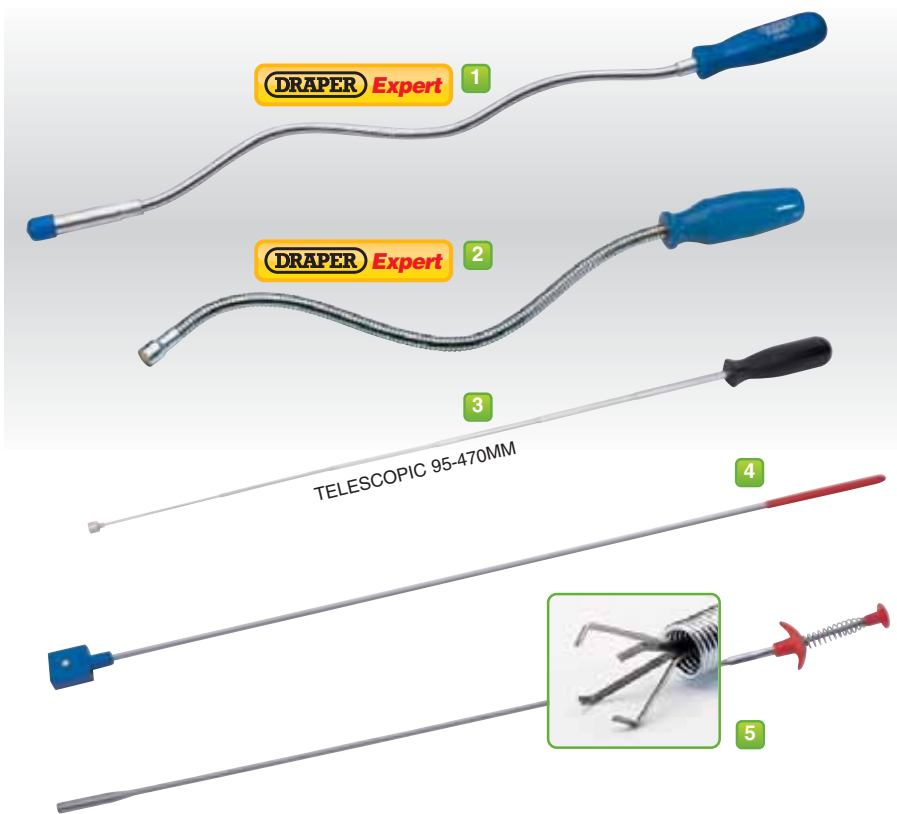

NEW



1 CAK/38A

38 Piece Self-Adjusting Clutch Kit

Expert Quality, necessary for pre-tensioning self-adjusting clutches prior to removal/installation preventing clutch damage and premature wear. Ideal for self-adjusting clutches on BMW, Fiat, GM Vauxhall/Opel, Mercedes Benz, Renault, Volvo and VW/Audi. Packed in blow mould storage carrying case with display sleeve. Display packed.

| Stock No. | Box Qty | Price per kit |
|-----------|---------|---------------|
| 38600 | - | €412.50P |

DRAPER Expert

NEW



3 CAK6-PRO

6 piece HGV Clutch Aligning Kit

Expert Quality, for fast accurate alignment of the flywheel pilot hole with clutch drive plate when assembling to vehicles. Supplied with four precision manufactured steel bushes and two expanding mandrels. Suitable for most HGV vehicles. Supplied in robust impact resistant plastic case. Display packed.

- Contents:
- 36-44mm diameter expanding mandrel
 - 44-52mm diameter expanding mandrel
 - 20mm diameter screw-in location pin
 - 25mm diameter screw-in location pin
 - 27mm diameter screw-in location pin
 - 30mm diameter screw-in location pin

| Stock No. | Box Qty | Price per kit |
|-----------|---------|---------------|
| 41803 | - | €286.25P |



5 NCAKA

17 piece Universal Clutch Aligning Kit

For fast accurate alignment of flywheel pilot hole and clutch drive plate when assembling to car. Precision manufactured steel bushes with chemically blacked finish. Suitable for use on most cars and light commercial vehicles. Display packed in handy storage case.

| Stock No. | Box Qty | Price per kit |
|-----------|---------|---------------|
| 39223 | - | €34.63D |

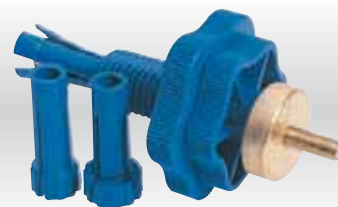

6 CAKT

Clutch Mate® - The Universal Clutch Aligning Assembly Tool

This revolutionary tool makes quick work of accurately aligning the clutch and pressure plate before fitting. Fits most vehicles up to 5 tons except vehicles with double plate clutches. Body manufactured from ABS with brass screw and supplied with three collets. A full instruction leaflet is included with each tool. Display packed.

| Stock No. | Box Qty | Price each |
|-----------|---------|------------|
| 52329 | 2 | €14.43D |



7 N141/A

Flywheel Puller

For use on Rover Group vehicles fitted with transverse 1100/1300cc power units with either diaphragm or verto clutches. Comprising drop forged carbon steel plate and bolts. Display packed.

| Stock No. | Box Qty | Price each |
|-----------|---------|------------|
| 19862 | - | €34.88D |

STOCKIST INFO
REVISED DEALER CODE APPLIES TO THIS ITEM



2 CAK11-PRO

11 piece Universal Clutch Aligning Kit

Expert Quality, for fast accurate alignment of flywheel pilot hole with clutch drive plate when assembling to vehicles. Supplied with eight precision manufactured steel bushes and three expanding mandrels. Suitable for most cars and light commercial vehicles. Display packed in storage case.

- Contents:
- 3 expanding mandrels size: 15-19mm dia.; 20-26mm dia. and 23-36mm dia.
 - Centring bushes: 12, 14, 15, 16, 17, 18, 19 and 20mm (O/D)

| Stock No. | Box Qty | Price per kit |
|-----------|---------|---------------|
| 23238 | - | €81.81P |

DRAPER Expert

STOCKIST INFO
REVISED DEALER CODE APPLIES TO THIS ITEM



4 CAK2-PRO

2 piece Universal Clutch Aligning Kit

Expert Quality, for fast accurate alignment of flywheel pilot hole with clutch drive plate when assembling to vehicles. Supplied with two precision manufactured tapered mandrels 15-19mm and 20-26mm. Suitable for most cars and light commercial vehicles. Display packed in storage case.

| Stock No. | Box Qty | Price per kit |
|-----------|---------|---------------|
| 23239 | - | €45.38P |

DRAPER Expert

PRODUCT INFORMATION

Every effort has been made to ensure that the applications shown in this Draper Tools Catalogue are accurate and include all the current car/van models. When using specialized automotive tools ALWAYS refer to the vehicle manufacturer's service or relevant Haynes manual for detailed and concise instruction of usage.

BOX QUANTITY INFORMATION

FOR YOUR CONVENIENCE, WE RECOMMEND ORDERING IN BOX QUANTITY OR MULTIPLES OF BOX QUANTITY WHERE SHOWN. YOU CAN STILL ORDER IN ANY QUANTITY UNLESS SPECIFICALLY STATED OTHERWISE



1 CAV1

Universal Cooling System Vacuum Purge and Refill Kit

Expert Quality, dramatically reduces cooling system refill time by preventing air-locks thus avoiding time-consuming cooling system bleeding. Plugs into air line then attaches to the cooling system to create a vacuum. Filler hose is then connected allowing pre-mixed coolant to flow easily into the system. Supplied with gauge, 1.3M of clear hose, four adaptors and hose end filler. Packed in carrying case.

| Stock No. | Box Qty | Price per kit |
|-----------|---------|---------------|
| 09544 | - | €88.18P |

NEW



2 UFK

Universal Filling Kit

Expert Quality, perfect for automotive use. This handy kit helps prevent air locks when refilling vehicle coolant systems. The kit comes complete with 31, 35, 40, 42, 45mm adaptors and a 35-14.5mm tapering cone making it compatible with most vehicles. Display packed.

| Stock No. | Box Qty | Price per kit |
|-----------|---------|---------------|
| 31029 | - | €64.46P |



3 RFS1

Radiator Comb/Cleaner Kit

Expert Quality, for use in the maintenance of automotive radiators and air conditioning/refrigeration grille fins to obtain maximum performance. 12 plastic combs (six per attachment) will clear debris from radiator fin matrixes as well as reshaping damaged or bent grille fins. Comb attachments fix to plastic handle with ball end nut. Display packed.

| Stock No. | Box Qty | Price per kit |
|-----------|---------|---------------|
| 43256 | - | €19.00D |

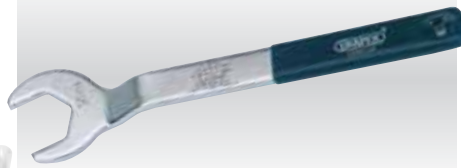

4 FHW36

36mm Thermo-Viscous Fan Nut Wrench

36 mm

Manufactured from pressed steel hardened, tempered and chrome plated with PVC dipped handle. For the removal of thermo-viscous fans fitted to Ford and GM (Vauxhall/Opel) vehicles. Display packed.

NB: Only for use on fixings of thermo-viscous fans on Ford and G.M. (Vauxhall/Opel) vehicles. NOT for general usage.

| Stock No. | Length | Box Qty | Price each |
|-----------|--------|---------|------------|
| 52582 | 270mm | 2 | €11.70D |

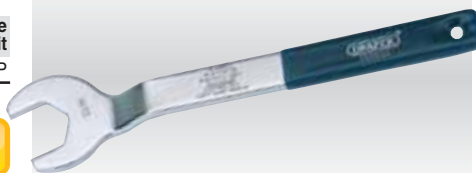

5 FHW32

32mm Thermo-Viscous Fan Nut Wrench

32 mm

Manufactured from pressed steel hardened, tempered and chrome plated with PVC dipped handle. For the removal of thermo-viscous fan hubs fitted to Ford and BMW vehicles. Display packed.

NB: Only for use on fixings of thermo-viscous fans on Ford and BMW vehicles. NOT for general usage.

| Stock No. | Length | Box Qty | Price each |
|-----------|--------|---------|------------|
| 52581 | 270mm | 2 | €11.70D |

SEE PRODUCT VIDEO
www.drapertools.com/drapertv



6 RHCP1

230mm Flexible Ratchet Hose Clamp Pliers

Expert Quality, for the removal and replacement of metal or plastic spring-loaded self-tightening hose clamps. Ideal for working in confined engine bays. Flexible long reach mechanism allows the pliers to release and lock hose clamps in the opened position. Fitted with 700mm long cable. For clamp diameters from 18mm to 54mm (approx.). Display packed.

| Stock No. | Box Qty | Price each |
|-----------|---------|------------|
| 89793 | - | €47.78P |



7 HCP5

5 piece Hose Clamp Pliers Kit

Expert Quality, popular selection to cover the vast majority of vehicles. For the removal and replacement of most types of spring-loaded self-tightening hose clamps. Packed in blow moulded case with display sleeve.

Contents:

- 280mm Flexible Ratchet Hose Clamp Pliers with twin remote cables 700mm long with flat ended hose clamping section - ideal for inaccessible confined spaces
- 250mm Spring-Loaded Multi-Purpose Hose and Wire Clamp Pliers with rotating curved interlocking jaw to help remove hoses from any angle - for use with air, water or liquid hoses up to 3/4" dia.
- 200mm Cup and Slot Pattern Ratchet Hose Clamp Pliers - for securely holding opened hose clamps
- 200mm Cross pattern Ratchet Hose Clamp Pliers - for securely holding opened hose clamps
- 200mm V Pattern Ratchet Hose Clamp Pliers - for securely holding opened hose clamps

| Stock No. | Box Qty | Price per kit |
|-----------|---------|---------------|
| 89794 | - | €118.00P |



8 HCP2

180mm Clic and Clic-R Hose Clamp Tool

Expert Quality, used to release and refit reusable hose clips. For releasing and refitting clic and clic-R type metal hose clips fitted to most engines. Spring loaded forged handles with PVC dipped grips. Display packed.

| Stock No. | Box Qty | Price each |
|-----------|---------|------------|
| 89791 | - | €37.68D |

NEW



1 HCP

Plastic Hose Clamp Pliers

Single-handed hose clamp pliers with locking mechanism. Manufactured from reinforced nylon with parallel closing smooth rounded 90° jaws designed to avoid clamp creep. Compared to conventional straight pliers the 90° jaws provide less deformation to clamped pipe preventing accidental damage. Display packed.

| Stock No. | Overall Size | Hose Capacity | Box Qty | Price each |
|-----------|--------------|---------------|---------|------------|
| 38384 | 155mm | 0-15mm | 6 | €9.98D |
| 38385 | 165mm | 0-22mm | 6 | €11.23D |
| 38386 | 220mm | 0-40mm | 6 | €14.38D |

NEW



2 HCP1/DA

Multi Directional Hose Clamp Pliers

Expert Quality spring loaded pliers for gripping hose clamps. Perfect when removing or replacing radiator pipes on cars and commercial vehicles. The grooved jaws clasp on both the sides and the front providing 270° access. Designed for standard hose clamps and VAG Group fuel line/ventilation pipe clamps. Manufactured from hardened steel with soft grip handles. Display packed.

| Stock No. | Capacity | Box Qty | Price each |
|-----------|----------|---------|------------|
| 38371 | 45mm | 10 | €40.63D |

NEW



3 HCP2/DA

Double Action Hose Clip Clamp

Expert Quality, perfectly suited for hard to reach hose clips deep within the engine bay. Used in conjunction with a 3/8" Sq. Dr. The steel construction and multi-grooved jaws provide secure gripping even in the restrictive spaces. Display packed.

| Stock No. | Box Qty | Price each |
|-----------|---------|------------|
| 38373 | 10 | €37.48D |

FUNNELS

Funnels for use with oil and other liquids are shown on page 177.



4 HC102

6-25mm Rubber Hose and Pipe Cutter

Plier-action cutter with diecast zinc alloy body. Fitted with reversible hardened and tempered replaceable steel blade. Length 190mm. Display packed.

| Stock No. | Description | Box Qty | Price each |
|-----------|---------------|---------|------------|
| 54463 | Pipe Cutter | 2 | €35.90D |
| 54485 | Cutting Blade | - | €14.73D |

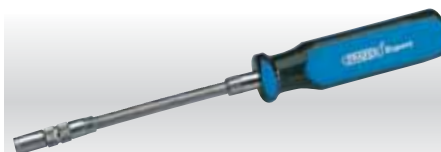

5 HCD

Hose Clip Driver

Expert Quality, for use on hose clips. Spring steel flexible shaft with 6 x 7mm hexagon adaptor to undo radiator hose clips. Triangular-shaped Super-Grip™ handles manufactured from black PVC afford excellent grip giving high torque. Display packed.

| Stock No. | Blade Length | Box Qty | Price each |
|-----------|--------------|---------|------------|
| 56945 | 150mm | 10 | €12.20D |



6

Hose Clamp Sets

Makes hose clamps of users required length. Two widths of banding available, 8 and 12mm. Each set is supplied with a 3M length of banding and eight tensioning clamps. Display packed.

| Stock No. | Part No. | Banding Width | Box Qty | Price per set |
|-----------|----------|---------------|---------|---------------|
| 55591 | HC8MM | 8mm | - | €10.70D |
| 55592 | HC12MM | 12mm | - | €15.10D |

STOCKIST INFO
REVISED DEALER
CODE APPLIES TO
THIS ITEM

7 ARFR

AdBlue® Refractometer Kit

Expert Quality, precision refractometer suitable for measuring Urea concentration in AdBlue® diesel exhaust fluid and will also measure anti-freeze strength. Focusable eyepiece and Automatic Temperature Corrected (ATC) prism ensures accuracy. Designed for use with standard ethylene glycol and propylene anti-freeze. Supplied with calibration screwdriver, calibration fluid, pipette and cleaning cloth. Packed in storage case. Specification:

| Refractometer measuring range | |
|-------------------------------|----------------|
| Urea | ... 0 to 40% |
| Anti-freeze | ... 0 to -50°C |

| Stock No. | Box Qty | Price per kit |
|-----------|---------|---------------|
| 23193 | - | €71.63P |

STOCKIST INFO
REVISED DEALER
CODE APPLIES TO
THIS ITEM



8 RFR

DRAPER Expert

Anti-Freeze, Battery and Screenwash Refractometer Kit

Expert Quality, precision refractometer used for measuring anti-freeze strength, battery fluid and screenwash strength. Designed for use with standard ethylene glycol and new organic acid technology (G14 etc.). Automatic temperature compensation (ATC) ensures accurate and dependable results. Supplied with calibration screwdriver, calibration fluid, pipette and cleaning cloth. Packed in storage case. Specification:

| Refractometer measuring range | |
|-------------------------------|-----------------|
| Anti-freeze | ... 0 to -50° |
| Battery fluid gravity | ... 1.10 - 1.40 |
| Screenwash | ... 0 to -40° |

| Stock No. | Box Qty | Price per kit |
|-----------|---------|---------------|
| 10645 | - | €71.63P |

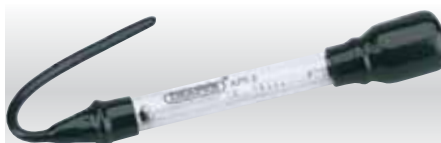

9 AFT-2

Anti-Freeze Tester

For testing ethylene glycol coolant (anti-freeze) density. With glass tube, PVC bulb and spout. Sold in plastic display tube.

| Stock No. | Range | Box Qty | Price each |
|-----------|-------------|---------|------------|
| 61794 | -5 to -40°C | - | €9.10D |

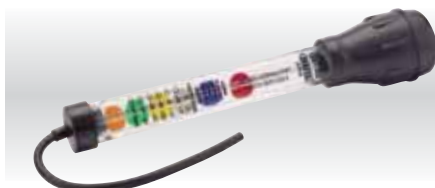

10 AFT-4

Anti-Freeze Tester (Disc Type)

For testing ethylene glycol coolant (anti-freeze) density only. With six floating discs for accurate reading in both celsius and fahrenheit. Display packed.

| Stock No. | Range | Box Qty | Price each |
|-----------|--------------------------|---------|------------|
| 10627 | -7 to -37°C/+25 to -34°F | - | €14.33D |



11 AFT-5

Anti-Freeze Tester (Dial Type)

For testing ethylene glycol coolant (anti-freeze) density only. Easy to read temperature scale for accurate interpretation of mixture density in both centigrade and fahrenheit. Display packed.

| Stock No. | Range | Box Qty | Price each |
|-----------|---------------------------|---------|------------|
| 10629 | -12 to -43°C/+10 to -45°F | - | €7.03D |

BOX QUANTITY INFORMATION

FOR YOUR CONVENIENCE, WE RECOMMEND ORDERING IN BOX QUANTITY OR MULTIPLES OF BOX QUANTITY WHERE SHOWN. YOU CAN STILL ORDER IN ANY QUANTITY UNLESS SPECIFICALLY STATED OTHERWISE

NEW



DRAPER Expert

1 TRRT-4PC

4 piece Track Rod Removal Tool Kit

Expert Quality, kit designed for easy removal and installation of ball joints on track rods. Knurled handle provides extra grip and three interchangeable heads offer complete versatility. Supplied with robust impact resistant plastic carrying box. Display packed.

Contents:

- Track rod arm length 350mm
- Interchangeable head sizes 30-35, 35-40 and 40-45mm

| Stock No. | Box Qty | Price per kit |
|-----------|---------|---------------|
| 42397 | - | €148.75P |

NEW



DRAPER Expert

4 N1000

Coil Spring Compressor Kit

Expert Quality, suitable for both Macpherson Strut Coil Springs and conical springs. Interchangeable jaws allow the kit to be used on a wide range of vehicles. Safety overload system ensures protection for user while yoke protectors stop the springs from being damaged. Packed in blow mould plastic carrying case with display sleeve. Display packed. Contents: • Main body with 21mm hex dr. and safety overload pin • 2 x gold jaws (80-115mm dia.) • 2 x black jaws (105-140mm dia.) • 2 x silver jaws (145-190mm dia.) • 3 x pairs of plastic covers • 1 x extension bracket with hex key

| Stock No. | Box Qty | Price per kit |
|-----------|---------|---------------|
| 22475 | - | €361.43P |



DRAPER Expert

5 N1200

Telescopic Spring Compressor Kit

Expert Quality, telescopic spring compressor with non-slip, three pronged arm feature for maximum grip. Allows the removal and replacement of coil springs on the suspension without dismantling the axle. Suitable for use on multi-link and independent suspensions (Max load capacity 1450kg). Display packed in blow mould case.

| Stock No. | Box Qty | Price per kit |
|-----------|---------|---------------|
| 26313 | - | €218.20P |

DRAPER Expert



STOCKIST INFO
REVISED DEALER CODES APPLY TO THESE ITEMS

2 TRRT-A

Track Rod Removal Tools

Expert Quality, for the easy removal and installation of track rod knuckles. Driving end of 1/2" sq. dr. (inner) and 27mm hex. (outer). 360mm hollow internal sleeve length/400mm overall length. Handle knurled for extra grip. Display packed.

| Stock No. | Capacity | Box Qty | Price each |
|-----------|----------|---------|------------|
| 27818 | 28-35mm | - | €77.75P |
| 27814 | 35-45mm | - | €81.69P |

DRAPER Expert

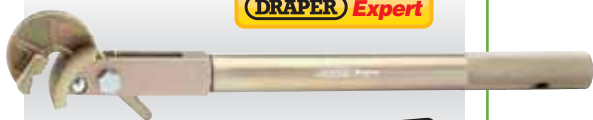

STOCKIST INFO
REVISED DEALER CODE APPLIES TO THIS ITEM

3 TRAT

Track Rod Adjusting Tool

Expert Quality, for loosening and adjusting stubborn track rods. The solid forged steel head and jaws allow more torque for less effort while the large surface area of the serrated jaws help prevent damage to the track rod. For use on 14-23mm diameter track rods. Overall length 385mm. Carton packed.

| Stock No. | Box Qty | Price each |
|-----------|---------|------------|
| 23236 | - | €89.98P |

OPEN CAGE

SLIDE IN COMPRESSOR UNTIL FULLY ENGAGED

LOCK DOWN CAGE LID



THE ABOVE DIAGRAMS SHOW COIL SPRING COMPRESSOR (STOCK No. 03054) BEING SECURELY PLACED IN SAFETY CAGE (STOCK No. 03053)

DRAPER Expert

6 N1500

1500kg Coil Spring Compressor

Expert Quality, designed for safe and effective compression of suspension springs to allow removal and replacement of the damper units. Safety overload system to protect user and spring compressor. Supplied with two jaw sets one for small springs size 80-145mm and the other for large springs size 145-195mm. A safety cage is available separately for minimizing the risk when working on suspension systems servicing (Stock No. 03053). Display carton.

| Stock No. | Part No. | Description | Box Qty | Price each |
|-----------|----------|-------------|---------|------------|
| 03054 | N1500 | Compressor | - | €553.20P |
| 03053 | N1600 | Safety Cage | - | €287.68P |

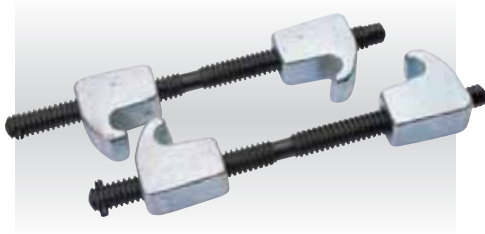

1 N144

2 piece Coil Spring Compressor Set

Hooks manufactured from tension ductile iron with galvanized finish. 16mm diameter carbon steel screws. Maximum opening 190mm. Display packed.

| Stock No. | Length | Box Qty | Price per set |
|-----------|--------|---------|---------------|
| 14173 | 250mm | - | €43.65D |



2 N152

2 piece Coil Spring Compressor Set

Wrap round claws with polished chrome finish. Lead screw manufactured from carbon steel hardened and tempered. Jaw design makes them suitable for use in confined areas. Maximum opening 220mm. Display carton.

| Stock No. | Box Qty | Price per set |
|-----------|---------|---------------|
| 68615 | - | €43.65D |



3 N145

2 piece Coil Spring Compressor Set

Forged carbon steel claws hardened and tempered. M16x1.5mm screw manufactured from carbon steel hardened, tempered with a chemically blacked finish. Capacity 90-200mm. Carton packed.

| Stock No. | Box Qty | Price per set |
|-----------|---------|---------------|
| 31497 | - | €62.38D |

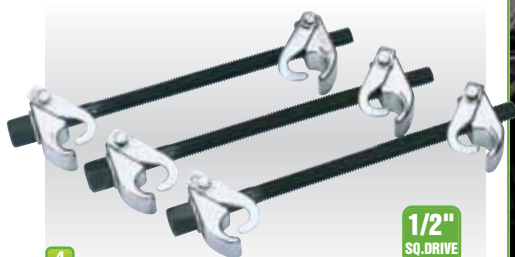

4 N151

3 piece Coil Spring Compressor Set

Cast steel claws with safety hooks to prevent accidental release. Lead screw manufactured from carbon steel hardened and tempered with 1/2" square drive facility. Maximum opening 224mm. Display carton.

| Stock No. | Box Qty | Price per set |
|-----------|---------|---------------|
| 68614 | - | €76.43D |

BALL JOINT SEPARATOR KIT



5 HBJS-01

Commercial Vehicle Hydraulic Ball Joint Separator Kit

Interchangeable jaws and forged carbon steel body allows ball joint on commercial vehicles to be removed with minimal effort by use of the hydraulic puller. Adjustable jaw opening with maximum opening capacity 95mm. Supplied with instruction manual. Packed in blow mould carrying case with display sleeve.

Contents: • hydraulic ram • 1 x manual thrust bolt 19 x 103mm long (approx) • 1 x manual thrust bolt 19 x 120mm long (approx) • 1 x insert screw bung with 24mm hex • 1 x 30mm jaw • 1 x 34mm jaw • 1 x 40mm jaw • 1 x main body

| Stock No. | Box Qty | Price per kit |
|-----------|---------|---------------|
| 22541 | - | €223.68P |



6 N139

Ball Joint Puller

Forged body with hardened thrust bolt. Direct action puller with a jaw capacity of 19mm. Suitable for use on most cars and some light commercial vehicles. Display packed.

| Stock No. | Box Qty | Price each |
|-----------|---------|------------|
| 13913 | - | €17.83D |

DRAPER Expert



7 N150

Ball Joint Separator

Expert Quality, forged carbon steel body, plated finish with steel bolt. Adjustable jaw opening 19-21mm, maximum opening capacity 50mm. Display packed.

| Stock No. | Box Qty | Price each |
|-----------|---------|------------|
| 63770 | - | €40.48D |

NEW

DRAPER Expert



8 N160

2 Stage Ball Joint Separator

Expert Quality, two stage design for use on most cars and light commercial vehicles. The off set lever provides excellent performance giving a maximum opening capacity 56mm. Manufactured from drop forged carbon steel. Display packed.

| Stock No. | Box Qty | Price each |
|-----------|---------|------------|
| 28882 | - | €37.48D |

PRODUCT INFORMATION

Every effort has been made to ensure that the applications shown in this Draper Tools Catalogue are accurate and include all the current car/van models. When using specialized automotive tools ALWAYS refer to the vehicle manufacturer's service or relevant Haynes manual for detailed and concise instruction of usage.

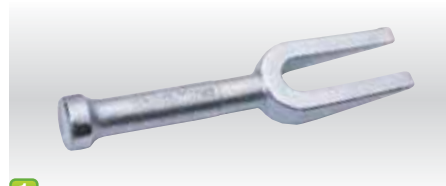

1 N143

Fork Type Ball Joint Separator

Forged carbon steel body with plated finish, with jaw opening 19mm and throat depth 70mm. Display packed.

| Stock No. | Length | Box Qty | Price each |
|-----------|--------|---------|------------|
| 14159 | 200mm | 6 | €17.45D |

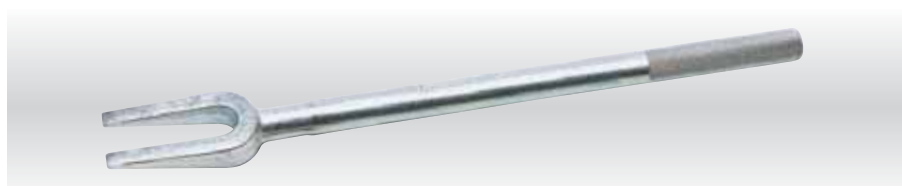

2 N148

Fork Type Ball Joint Separator

Forged carbon steel body with plated finish. Jaw opening 19mm and throat depth 70mm. Display packed.

| Stock No. | Length | Box Qty | Price each |
|-----------|--------|---------|------------|
| 38859 | 400mm | 4 | €22.15D |

DRAPER Expert

DRAPER Expert



3 CVBT2

Pneumatic CV Boot Stretcher

Expert Quality, innovative labour-saving tool for replacing "stretchy" type CV boots. Fitted with a 1/4" air inlet and operated in conjunction with a standard air line (sold separately). Lightweight construction with simple button control on handle opening the expanding arms to a maximum of 110mm. Suitable for most cars and small commercial vehicles but only in conjunction with "stretchy" style CV boots. Carton packed.

Specification:

Max: opening capacity ... 110mm
Max: operating pressure ... 100 psi (7bar)

| Stock No. | Box Qty | Price each |
|-----------|---------|------------|
| 12098 | - | €127.53P |



4 CVBK3

3 piece CV Boot Service Kit

Expert Quality, for the correct cutting, tensioning and clamping of the CV joint band. Display packed.

Contents: • 200mm precision CV boot band cutters for use on CV bands up to 6mm wide • 225mm CV band cutting tool • 240mm CV pliers for tightening ear-type CV bands. Reinforced 1/2" sq. dr. recesses in handle for the use of a breaker bar/ torque wrench where specific torque is required

| Stock No. | Box Qty | Price per kit |
|-----------|---------|---------------|
| 30784 | - | €110.05D |

NEW



5 CVBT-A

CV Boot Tool

This tool allows the user to renew the CV boot of a vehicle without dismantling the CV joint. Manufactured from nylon with a 19mm hexagon bar fitted to the base. Display packed.

| Stock No. | Tool Length | Box Qty | Price each |
|-----------|-------------|---------|------------|
| 36702 | 315mm | 6 | €18.69D |

SUSPENSION ARM LEVER



6 LAL

Suspension Arm Lever

Expert Quality, for use on suspension arm and hub work maintenance. Soft grip handle with adjustable hook allows easy use on either side of the vehicle. Adjustable fulcrum gives maximum leverage with minimum effort. Display packed.

| Stock No. | Length | Box Qty | Price each |
|-----------|--------|---------|------------|
| 23251 | 1170mm | - | €126.53P |

DRAPER Expert



AIR LINES AND AIR LINE FITTINGS

A complete selection of 1/4", 3/8" and 1/2" air lines are available on pages 579-580. This selection includes recoil, whip hoses and straight air lines in a variety of different lengths. Also we supply a wide selection of connectors and fittings on pages 581-585.





1 CWBT39A

DRAPER Expert

39 piece Brake Piston Wind Back Tool Kit

Expert Quality, comprehensive kit designed to allow quick and efficient brake servicing for most vehicles. Supplied with left handed and right handed winders for returning the brake piston into the caliper providing clearance for new brake pads. Includes pin punches, brake keys, pentagon bit and sockets. Packed in blow mould storage carrying case with display sleeve. Display packed.

| Stock No. | Box Qty | Price per kit |
|-----------|---------|---------------|
| 21859 | - | €143.23P |



2 CWBT18A

DRAPER Expert

18 piece Brake Piston Wind Back Tool Kit

Expert Quality, for professional and DIY mechanics, left and right handed winders allow easy return of the brake piston into the caliper providing clearance for replacement brake pads. Fits most vehicles. Packed in blow mould storage carrying case with display sleeve. Display packed.

| Stock No. | Box Qty | Price per kit |
|-----------|---------|---------------|
| 22461 | - | €77.75P |



3 APCT-16PC

DRAPER Expert

16 Piece Pneumatic Brake Piston Wind Back Tool Kit

Expert Quality, pneumatic winder allows left and right handed winding for easy return of the brake piston into the caliper to provide clearance for new brake pads. Manufactured from aluminium with black anodized finish and standard 1/4" air inlet adaptor. 15 adaptor plates fit most popular vehicles. Packed in blow mould storage carrying case with display sleeve. Display packed.

| Stock No. | Box Qty | Price per kit |
|-----------|---------|---------------|
| 12086 | - | €171.15P |



4 372

DRAPER Expert

8 piece Brake Piston Wind Back Tool Kit

Expert Quality, right handed winder allows the easy return of the brake piston into the caliper to provide clearance for new brake pads. Fits most vehicles. Packed in blow mould storage carrying case with display sleeve. Display packed.

| Stock No. | Box Qty | Price per kit |
|-----------|---------|---------------|
| 33606 | - | €62.53P |

PRODUCT INFORMATION

Every effort has been made to ensure that the applications shown in this Draper Tools Catalogue are accurate and include all the current car/van models. When using specialized automotive tools ALWAYS refer to the vehicle manufacturer's service or relevant Haynes manual for detailed and concise instruction of usage.

DRAPER® WORKSHOP EQUIPMENT

We have an extensive range of professional quality workshop tools and equipment.

The following product groups are just a small part of our range...



Lifting Equipment

pages 144-163

Engine Cranes, Gearbox Supports, Transmission Stands, and a range of Trolley and Bottle Jacks, all these products and lots more are in section 3 of this catalogue

Welding Tools

pages 539-554



ARC, MIG and TIG welding machines, helmets, shrouds, gases and much more!

Compressors & Air Tools

pages 555-585



Oil-free, low noise, belt driven and direct drive compressors. Composite body and conventional air tools complemented by appropriate air line fittings.

NEW

DRAPER Expert



1 CWBT
BMW-Mini Brake Piston Wind-Back Tool

Expert Quality, for winding back calipers on R50, R52, and R53 pre 2007 BMW-Mini's. Manufactured from carbon steel. Display packed.

| Stock No. | Pin Centres | Pin Width | Box Qty | Price each |
|-----------|-------------|-----------|---------|------------|
| 38191 | 19mm | 5mm | - | €12.48D |

NEW

DRAPER Expert



4 CWBT
Nissan/Vauxhall Brake Piston Wind-Back Tool

Expert Quality, for winding back calipers on selected Nissan vehicles and Vauxhall Astras. Manufactured from carbon steel and used with 3/8" Sq. Dr. Display packed.

| Stock No. | Pin Centre | Pin Width | Box Qty | Price each |
|-----------|------------|-----------|---------|------------|
| 38195 | 32mm | 6mm | - | €11.88D |

NEW

DRAPER Expert



7 CWBT
BMW, Ford, Lancia, Proton, Renault, Rover, Saab, VAG Group, Vauxhall Brake Piston Wind-Back Tool

Expert Quality, for winding back calipers on selected BMW, Ford, Lancia, Proton, Renault, Rover, Saab, VAG Group and Vauxhall vehicles. Manufactured from carbon steel and used with 3/8" Sq. Dr. Display packed.

| Stock No. | Pin Centre | Pin Width | Box Qty | Price each |
|-----------|------------|-----------|---------|------------|
| 38200 | 20mm | 4mm | - | €13.73D |

NEW

DRAPER Expert



2 CWBT
Renault Brake Piston Wind-Back Tool

Expert Quality, for winding back calipers on Renault Clio. Manufactured from carbon steel and used with 3/8" Sq. Dr. Display packed.

| Stock No. | Pin Centres | Pin Width | Box Qty | Price each |
|-----------|-------------|-----------|---------|------------|
| 38193 | 31mm | 4mm | - | €9.38D |

NEW

DRAPER Expert



5 CWBT
Renault Brake Piston Wind-Back Tool

Expert Quality, for winding back calipers on Renault Modus vehicles. Manufactured from carbon steel and used with 3/8" Sq. Dr. Display packed.

| Stock No. | Pin Centre | Pin Width | Box Qty | Price each |
|-----------|------------|-----------|---------|------------|
| 38198 | 20mm | 4mm | - | €9.38D |

NEW

DRAPER Expert



8 CWBT
Peugeot Brake Piston Wind-Back Tool

Expert Quality, for winding back calipers on Peugeot 206 CC/HDI/GTI vehicles. Manufactured from carbon steel and used with 3/8" Sq. Dr. Display packed.

| Stock No. | Pin Centre | Pin Width | Box Qty | Price each |
|-----------|------------|-----------|---------|------------|
| 38201 | 23mm | 6mm | - | €12.48D |

NEW

DRAPER Expert



3 CWBT
Ford Brake Piston Wind-Back Tool

Expert Quality, for winding back calipers on Ford Mondeo and Galaxy. Manufactured from carbon steel and used with 3/8" Sq. Dr. Display packed.

| Stock No. | Centre Shape | Box Qty | Price each |
|-----------|--------------|---------|------------|
| 38194 | 12mm Hex | - | €4.98D |

NEW

DRAPER Expert



6 CWBT
Ford, Lancia, Renault, Rover, VAG Group Brake Piston Wind-Back Tool

Expert Quality, for winding back calipers on selected Ford, Lancia, Renault, Rover, VAG Group vehicles. Manufactured from carbon steel and used with 3/8" Sq. Dr. Display packed.

| Stock No. | Pin Centre | Pin Width | Box Qty | Price each |
|-----------|------------|-----------|---------|------------|
| 38199 | 20mm | 4mm | - | €13.73D |

NEW

DRAPER Expert



9 CWBT
Ford, Honda, Nissan, Renault Brake Piston Wind-Back Tool

Expert Quality, for winding back calipers on Ford, Honda, Nissan, Renault vehicles. Manufactured from carbon steel and used with 3/8" Sq. Dr. Display packed.

| Stock No. | Pin Centre | Pin Width | Box Qty | Price each |
|-----------|------------|-----------|---------|------------|
| 38202 | 20mm | 5mm | - | €13.13D |

NEW

DRAPER Expert

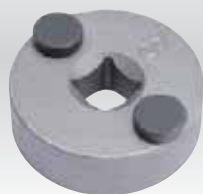

1 CWBT

Ford/Subaru Brake Piston Wind-Back Tool

Expert Quality, for winding back calipers on Ford/Subaru vehicles. Manufactured from carbon steel and used with 3/8" Sq. Dr. Display packed.

| Stock No. | Pin Centres | Pin Width | Box Qty | Price each |
|-----------|-------------|-----------|---------|------------|
| 38185 | 29mm | 10mm | - | €12.48D |

NEW

DRAPER Expert



2 CWBT

Citroën/Renault Brake Piston Wind-Back Tool

Expert Quality, for winding back calipers on Citroën/Renault vehicles. Manufactured from carbon steel and used with 3/8" Sq. Dr. Display packed.

| Stock No. | Pin Centres | Pin Width | Box Qty | Price each |
|-----------|-------------|-----------|---------|------------|
| 38187 | 43mm | 6mm | - | €14.98D |

NEW

DRAPER Expert



3 CWT-VAG-3PIN

VAG 3 Pin Brake Caliper Wind-Back Adaptor

Expert Quality, for winding back calipers on VAG vehicles fitted with EPB calipers. Manufactured from carbon steel and used with 3/8" Sq. Dr. Display packed.

| Stock No. | Box Qty | Price each |
|-----------|---------|------------|
| 33320 | - | €9.99D |



4 CWT-VAG

VAG Low Profile Rear Brake Caliper Wind Back Tool

Expert Quality, for quick and efficient winding of the brakes pistons in low profile rear calipers on Audi and VW vehicles. Display packed.

| Stock No. | Box Qty | Price each |
|-----------|---------|------------|
| 26314 | - | €39.55D |



5 CWT1

3/8" Sq. Dr. Rear Brake Caliper Wind-Back Cube

Suitable for most rear brake calipers. Allows the caliper piston to be wound back for the fitting of new brake pads. Five key patterns, chemically blacked finish. Display packed.

NB: Not for use with calipers where pressure is required to rewind

| Stock No. | Box Qty | Price each |
|-----------|---------|------------|
| 52334 | 12 | €13.18D |

NEW

DRAPER Expert



6 CWT2A

1/2" Sq. Dr. Brake Caliper Wind-Back Tool

Expert Quality, ensures parallel piston retraction avoiding damage to the piston seals. For use on opposed fixed and single piston sliding calipers. Display packed.

| Stock No. | Box Qty | Price each |
|-----------|---------|------------|
| 38205 | - | €31.19D |



7 179

ABS Brake Servicing Tool

To wind back the brake pistons on ABS brakes. Suitable for most Ford and Rover vehicles fitted with ABS. Display packed.

| Stock No. | Box Qty | Price each |
|-----------|---------|------------|
| 22349 | - | €22.70D |



PRODUCT INFORMATION

Every effort has been made to ensure that the applications shown in this Draper Tools Catalogue are accurate and include all the current car/van models. When using specialized automotive tools ALWAYS refer to the vehicle manufacturer's service or relevant Haynes manual for detailed and concise instruction of usage.

BOX QUANTITY INFORMATION

FOR YOUR CONVENIENCE, WE RECOMMEND ORDERING IN BOX QUANTITY OR MULTIPLES OF BOX QUANTITY WHERE SHOWN. YOU CAN STILL ORDER IN ANY QUANTITY UNLESS SPECIFICALLY STATED OTHERWISE

DAVE SAYS

These great brake pipe flaring tools (Item Nos. 1, 2, 4 & 5) are designed for use in the professional workshop. The forming dies and punches are machined to a high degree of accuracy, ensuring consistent and repeatable pipe flares with excellent fluid seals - absolutely essential for brakes.



1 BPF/PRO/TURRET

Brake Pipe Flaring Turret Kit

Expert Quality, for SAE convex, DIN convex and SAE double flaring on brake pipes. Performs single and double flares with ease. Mounts in a bench vice for secure accurate use. Rotating turret selector for ease of use when choosing the relevant punch in creating flares. Supplied with three sets of interchangeable forming blocks for rapid set up. Display packed in blow mould case.

| Stock No. | Box Qty | Price per kit |
|-----------|---------|---------------|
| 23310 | - | €207.85P |

2 BPF/PRO/SLIDER

Brake Pipe Flaring Slider Kit

Expert Quality, for SAE convex, DIN convex, 37° double and SAE double flaring on brake pipes. Performs single and double flares with ease. Mounts in a bench vice for secure accurate use. Supplied with three sliding forming blocks for rapid set up. Display packed in blow mould case.

| Stock No. | Box Qty | Price per kit |
|-----------|---------|---------------|
| 23311 | - | €154.45P |



3 BPF/KIT

Brake Pipe Flaring Tool Kit

For single or double lap flares in soft copper and aluminium pipe. Suitable for 3/16", 1/4", 5/16", 3/8" and 1/2" O/D pipes. Pipe clamp, 45° spreader and five dies. Packed in handy plastic case. Display packed.

| Stock No. | Description | Box Qty | Price per kit |
|-----------|-----------------|---------|---------------|
| 37870 | Tool Kit | - | €39.93P |
| 50810 | Spare die 3/16" | - | €3.43D |
| 50812 | Spare die 1/4" | - | €3.43D |
| 50813 | Spare die 3/8" | - | €3.43D |
| 50814 | Spare die 1/2" | - | €3.58D |
| 51880 | Spare die 5/16" | - | €3.43D |



4 BPF/HAND/SAE

3/16" SAE Hand-Held Brake Pipe Flaring Tool

Expert Quality, easy to use hand-held tool for quick accurate automotive pipe flaring. Ideal for use with pipes attached to the vehicle. Display packed.

| Stock No. | Box Qty | Price each |
|-----------|---------|------------|
| 23312 | - | €59.78P |



5 BPF/HAND/DIN

4.75mm DIN Hand-Held Brake Pipe Flaring Tool

Expert Quality, easy to use hand-held tool for quick accurate automotive pipe flaring. Ideal for use with pipes attached to the vehicle. Display packed.

| Stock No. | Box Qty | Price each |
|-----------|---------|------------|
| 23313 | - | €59.78P |



6 TC16

3-22mm Mini Tubing Cutter

Adjustable, for small bore tubing or in-situ applications where space is limited. Diecast aluminium body, hardened steel blade, two flare groove rollers and deburring reamer in adjusting knob. Display packed.

| Stock No. | Description | Box Qty | Price each |
|-----------|---------------|---------|------------|
| 10579 | Cutter | 4 | €14.73D |
| 26933 | Cutting Wheel | - | €2.70D |



7 BAW-FN

10 x 11mm Flare Nut Wrench

Designed for use on compression nuts fitted on petrol, diesel injection pipes and hydraulic gas or refrigeration systems. Manufactured from chrome vanadium steel hardened, tempered and chrome plated for corrosion protection. Display packed.

| Stock No. | Box Qty | Price each |
|-----------|---------|------------|
| 31967 | - | €6.98D |



8 BPR7A

7mm Brake Pad Key with Handle

Expert Quality, chrome vanadium steel key hardened and tempered with a chemically blacked finish. Suitable for various brake pad replacement applications on BMW, Ford and VW/Audi vehicles. Handle length: 140mm. Display packed.

| Stock No. | Box Qty | Price each |
|-----------|---------|------------|
| 68425 | - | €5.50D |



9 BPR8A

8mm Brake Pad Key with Handle

Expert Quality, chrome vanadium steel key hardened and tempered with a chemically blacked finish. Suitable for disc brake caliper retaining bolts on most BMW models, and GM (Vauxhall/Opel) models. Handle length 140mm. Display packed.

| Stock No. | Box Qty | Price each |
|-----------|---------|------------|
| 68424 | - | €5.50D |

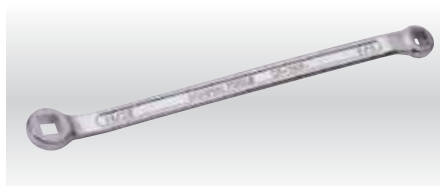

1 BAW

Brake Adjusting Wrenches

Forged from chrome vanadium steel hardened, tempered and chrome plated for corrosion protection. Length 175mm. Display packed.

| Stock No. | Size | Box Qty | Price each |
|-----------|---------------------|---------|------------|
| 07200 | 1/4 x 5/16" AF sq. | - | €5.65D |
| 12329 | 1/4 x 11/32" AF sq. | - | €5.65D |



2 BSCP

Brake Spring Compression Pliers

Unique offset design for removal of most 'top hat' brake shoe retaining springs and pins. Offset jaws enable easy access to spring cap located behind wheel hubs. Display packed.

| Stock No. | Box Qty | Price each |
|-----------|---------|------------|
| 22489 | - | €51.83D |



3 BSHS

Brake and Headlight Spring Hook

Ideal for removal and installation of hard to reach brake and headlight springs. Manufactured from heat treated alloy steel and chemically blacked for corrosion protection. Display packed.

| Stock No. | Box Qty | Price each |
|-----------|---------|------------|
| 24317 | - | €13.63D |



4 394

Hydraulic Brake Hose Clamp

Designed as a single-handed snap action tool for clamping off hydraulic hoses when working on braking systems. Manufactured from 90 ton tensile steel, fully heat treated with plastic coated handles. Display packed.

| Stock No. | Box Qty | Price each |
|-----------|---------|------------|
| 11534 | 12 | €8.33D |



5 BPTG8

Brake Lining Thickness Guide

Expert Quality, for quickly checking remaining life of brake linings. Offset blade is inserted between brake disc and brake pad. Three blade colours signify wear; red for replace now, yellow for replace soon and green for OK. Marked in metric with imperial equivalents. Display packed.

Contents: red 2 and 3mm; yellow 4, 5 and 6mm; green 8, 10 and 12mm

| Stock No. | Box Qty | Price each |
|-----------|---------|------------|
| 30819 | 6 | €23.50D |



7 BFT1

Brake Fluid Tester

Specially designed for checking the moisture content in brake fluid. Comparative electrolyte-type tester which passes current through the fluid and measures any resistance present. Simple to calibrate, very easy to use and read with an audible test cycle. Adjustable test probe for easy access. Uses 1 x 9V battery (PP3 - sold separately). Display packed.

| Stock No. | Description | Box Qty | Price each |
|-----------|---------------|---------|------------|
| 59078 | Tester | - | €73.30P |
| 61837 | Battery (PP3) | 12 | €7.38D |

NEW

DRAPER Expert

8 RPS

650cc Aluminium Refillable Pressure Sprayer

Expert Quality, screw-top refillable canister suitable for most workshop applications. Fitted with automatic safety release valve pre-set at 90 Psi (6.3Bar) and dual action extra long folding nozzle for difficult access areas. Pressurized via standard Schrader valve. Display packed.

| Stock No. | Box Qty | Price each |
|-----------|---------|------------|
| 28820 | - | €62.48D |



6 BFT2

12V Electronic Brake Fluid Tester

Expert Quality, uses boiling point detection on DOT3, DOT4 and DOT5.1 brake fluid to ascertain when it requires replacement through water contamination. Pipette and reservoir for use on small systems, for example motorcycles. Can be used on most types of vehicle including motorcycles. Runs off 12V car battery. Supplied with crocodile clips and 1.7M of cable. Display packed in blow mould case.

| Stock No. | Box Qty | Price each |
|-----------|---------|------------|
| 41392 | - | €327.13P |



STOCKIST INFO
REVISED DEALER
CODES APPLY TO
ITEMS 2, 5 & 6
ON THIS PAGE



1 BFE1

Pneumatic Brake Fluid Extractor

Expert Quality, ideal for one person operation. For the extraction of brake fluid from hydraulic systems - especially those with complex ABS systems, using a compressed air supply. Waste brake fluid tank manufactured from translucent and hydrocarbon-resistant plastic. Supplied with 1.5M of metal sprung suction tube and three extraction straws including a double adaptor suitable for twin disc motorcycles. Display carton.

Specification:

| | |
|-----------------------|--------------|
| Reservoir capacity | ... 5L |
| Air inlet size | ... 1/4" BSP |
| Suction tube pressure | ... 0.8MPa |
| Weight (empty) | ... 2.9kg |

| Stock No. | Box Qty | Price each |
|-----------|---------|------------|
| 77056 | - | €99.10P |



2 BBK3A

Pneumatic Universal Brake Bleeding Kit

Expert Quality, one person hand-operated kit that allows fluid to be drawn from the bleed nipple allowing either bleeding or full replacement of system on cars, vans, trucks and motor bikes. Magnetic bases on refilling bottles. Does not require brake reservoir caps. Supplied with reservoir top-up kit. Display carton.

Specification:

| | |
|--------------------------------------|-------------------------------|
| Air supply | ... 70-120psi (4.8-8.3bar) |
| Container capacity | ... 0.75L |
| Air inlet size - nipple not supplied | ... 1/4" BSP |

| Stock No. | Box Qty | Price per kit |
|-----------|---------|---------------|
| 71205 | - | €56.50P |



3 OE1

Pneumatic Oil Extraction/Brake Bleeding Kit

Expert Quality, single person operation. For the extraction of engine oils from motor vehicles, motor bikes, marine engines, generators etc. without the removal of the oil drain plug. Requires 71-110psi air supply. Supplied with 1.4M of anti-kink hose, 4 x siphon hoses and brake bleeding hose/connector. Display carton.

Specification:

| | |
|---------------------|------------------------|
| Air supply | ... 70-110psi (5-8bar) |
| Av. air consumption | ... 180L/min |
| Reservoir capacity | ... 10L |
| Oil extraction rate | ... 2.5L/min |
| Air inlet size | ... 1/4" BSP |
| Vacuum | ... 500mm HG (max.) |
| Weight | ... 2.8kg |

| Stock No. | Box Qty | Price per kit |
|-----------|---------|---------------|
| 73291 | - | €144.65P |

NEW



4 PBBK

Pneumatic Brake Bleeder Kit

Expert Quality, for use on vehicles unable to have brakes bled by the suction method and ABS systems. The pre-chargeable low-pressure 20psi portable tank ensures connectivity to most vehicles with a standard European reservoir connector. Supplied with bleed bottle, adaptors and 5L stainless steel reservoir, reducing the risk of running the system dry during the bleeding process. Used in conjunction with Brake Bleeder Adaptor Kit, Stock No. 28836 (sold separately). Carton packed.

| Stock No. | Box Qty | Price per kit |
|-----------|---------|---------------|
| 28833 | - | €311.25P |

NEW



5 UBCA

Universal Brake Cap Adaptor

Expert Quality, the unique stepped cap fits the brake-fluid reservoirs on most cars and light commercial vehicles. Supplied with quick connector and used in conjunction with Pneumatic Brake Bleeder Stock No. 28833. Display packed.

| Stock No. | Box Qty | Price each |
|-----------|---------|------------|
| 28837 | - | €26.20P |

6 MPBB

Pump Action Brake Bleeder

Pump action manual brake bleeder ideal for one person operation on vehicles unable to be bled using suction methods. Fitted with pressure gauge, release valve, spring loaded hose coupling and supplied with 1M (approx) of flexible hose. 2L clean brake fluid capacity, ideal for busy workshop environments. Carton packed.

| Stock No. | Box Qty | Price each |
|-----------|---------|------------|
| 22495 | - | €74.98P |

PRODUCT INFORMATION

Every effort has been made to ensure that the applications shown in this Draper Tools Catalogue are accurate and include all the current car/van models. When using specialized automotive tools ALWAYS refer to the vehicle manufacturer's service or relevant Haynes manual for detailed and concise instruction of usage.

STOCKIST INFO
REVISED DEALER
CODES APPLY TO
ITEMS 3, 6 & 7
ON THIS PAGE

DRAPER Expert



1 BBAK

Brake Bleeder Adaptor Kit

Expert Quality, single person operated brake bleeder for a range of popular vehicles with ABS systems and for vehicles unable to have brakes bled by the suction method. Can also bleed hydraulic clutches. Used in conjunction with pneumatic brake bleeders like the Draper 28833. Supplied with convenient carrying/storage case.

| Stock No. | Box Qty | Price per kit |
|-----------|---------|---------------|
| 28836 | - | €186.25P |



PAUL SAYS

The sprayers shown on this page have FPM seals which allow their use with certain hazardous liquids such as brake cleaner, solvent, scale removers, anti-mould solutions etc. Operators should wear the correct eye protection, gloves, respirator and footwear - much of which can be found in Section 10, Personal Protective Equipment.

QUALITY ASSURANCE MAKES THE DIFFERENCE

First aid kits and eye wash solution should always be available nearby to where the work is taking place.

DRAPER Expert



6 EWS-2FPM

2L Brake Cleaner FPM Sprayer

Expert Quality, high quality virgin plastic with FPM seals which allow for use with: solvents, fuel, acids, scale removers, waterproofing, anti-mould solutions, oils and lubricants. Container is graduated in 200ml increments up to its actual capacity of 1.8L which allows for air pressurization of sprayer. Adjustable spray pattern. Overall height excluding handle 190mm. Display packed.

| Stock No. | Box Qty | Price each |
|-----------|---------|------------|
| 02709 | - | €20.31P |



2 BBK1

Brake Bleeding Kit

A kit designed for one person bleeding of brakes. The one way valve incorporated in the 600mm long silicon tube prevents air returning into the brake system whilst brake bleeding. Display packed.

| Stock No. | Box Qty | Price per kit |
|-----------|---------|---------------|
| 37316 | 2 | €15.80D |

NEW

DRAPER Expert



4 FSS12PC

12 piece Fluid Stop Set

Expert Quality, all-inclusive kit for stopping the flow of fluid from Fuel/Brake lines during disconnection and maintenance. Supplied with carrying case. Display packed.

| Stock No. | Box Qty | Price per set |
|-----------|---------|---------------|
| 28835 | - | €91.19D |



DRAPER Expert



3 BFAF

Brake Fluid Auto Filler

Expert Quality, eliminates the need for a second person while topping up the brake reservoir when bleeding brakes. Maintains fluid level during operation reducing risk of accidental spillage during topping up. Offset fluid bottle with adjustable neck for easy engine access and airtight fixtures ensures fluid can be stored safely without risk of contamination. Display packed.

| Stock No. | Box Qty | Price each |
|-----------|---------|------------|
| 22270 | - | €24.98P |

NEW

DRAPER Expert



5 FSS4PC

4 piece Fluid Stop Set

Expert Quality, manufactured for stopping the flow of fluid from Fuel/Brake lines during disconnection and maintenance. Display packed.

| Stock No. | Box Qty | Price per set |
|-----------|---------|---------------|
| 28834 | - | €21.19D |

DRAPER Expert



7 EWS-7-FPM

7L Brake Cleaner FPM Pump Sprayer

Expert Quality, high quality virgin plastic with FPM seals which allow for use with: solvents, fuel, acids, scale removers, waterproofing, anti-mould solutions, oils and lubricants. Container is graduated in 1L increments up to its actual capacity of 5.5L which allows for air pressurization of sprayer. Safety valve prevents over pressurization. 600mm long lance with adjustable spray pattern and 1.5M (approx.) of reinforced delivery tube. Adjustable shoulder strap. Overall height excluding handle 390mm. Display packed.

| Stock No. | Box Qty | Price each |
|-----------|---------|------------|
| 02708 | - | €73.31P |

BOX QUANTITY INFORMATION

FOR YOUR CONVENIENCE, WE RECOMMEND ORDERING IN BOX QUANTITY OR MULTIPLES OF BOX QUANTITY WHERE SHOWN. YOU CAN STILL ORDER IN ANY QUANTITY UNLESS SPECIFICALLY STATED OTHERWISE

DRAPER Expert



1 TI ACCURA

PCL Accura 1 Digital Tyre Inflator

Manufactured and certified to Directive 86/217/EEC **Expert Quality**, digital readout tyre inflator with clip-on connector suitable for use in transport depots and tyre fitting bays where speed and accuracy are paramount. Lightweight and shockproof with a biomorphic handle together with the direct valve mechanism provide user comfort and excellent rates of inflation/deflation. The pressure is checked by a robust ceramic sensor allowing precise measurement with tolerances well above the industry standard 86/217/EEC. **Reads in psi only.** Supplied with 3V lithium battery. Carton packed.

Specification:

| | |
|-----------------------|------------------------|
| Inflation flow | ... 910L/min@13bar |
| Inflation range | ... 0-174psi |
| Inlet pressure (max.) | ... 218psi |
| Supply inlet | ... 1/4" BSP taper (F) |
| Hose length | ... 1.8M (approx.) |

| Stock No. | Description | Box Qty | Price each |
|-----------|--------------------|---------|------------|
| 42598 | Inflator | - | €150.55P |
| 03258 | Sp. Hose Connector | - | €59.13P |

DRAPER Expert



2 TI AIRFORCE

PCL Airforce Analogue Tyre Inflator

Manufactured and certified to Directive 86/217/EEC **Expert Quality**, analogue tyre inflator with clip-on connector suitable for use in transport depots and tyre fitting bays where speed and accuracy are paramount. Lightweight and shockproof bourbon tube/beryllium construction together with the direct valve mechanism provide user comfort and excellent rates of inflation/deflation. The pressure is checked by a robust ceramic sensor allowing precise measurement with tolerances well above the industry standard 86/217/EEC. **Reads in psi/bar/kPa.** Carton packed.

Specification:

| | |
|-----------------------|----------------------------|
| Inflation flow | ... 910L/min@13bar |
| Inflation range | ... 0-12bar/174psi/1200kPa |
| Inlet pressure (max.) | ... 15bar/218psi/1500kPa |
| Supply inlet | ... 1/4" BSP taper (F) |
| Hose length | ... 1.8M |

| Stock No. | Description | Box Qty | Price each |
|-----------|--------------------|---------|------------|
| 42599 | Inflator | - | €99.00P |
| 03258 | Sp. Hose Connector | - | €59.13P |



NEW



5 4290B

Air Line Inflator with Open Ended Clip On Connector

Inflator with single open-ended clip on connector. Allows fast and simple tyre inflation. Display packed.

Specification:

| | |
|-------------------------|-------------------------|
| Pressure range | ... 0.7-11bar/10-160psi |
| Max air supply pressure | ... 17.2bar/250psi |
| Supply inlet | ... 1/4" BSP taper (F) |
| Hose length | ... 0.4M (approx.) |

| Stock No. | Box Qty | Price each |
|-----------|---------|------------|
| 36633 | 6 | €54.98P |

NEW



6 4290

Air Line Inflator with Twin Open Ended Push On Connectors

Inflator with twin open-ended push on connectors. Allows fast and simple tyre inflation. Display packed.

Specification:

| | |
|-------------------------|-------------------------|
| Pressure range | ... 0.7-11bar/10-160psi |
| Max air supply pressure | ... 17.2bar/250psi |
| Supply inlet | ... 1/4" BSP taper (F) |
| Hose length | ... 0.6M (approx.) |

| Stock No. | Box Qty | Price each |
|-----------|---------|------------|
| 36632 | 6 | €56.23P |

DRAPER Expert



3 ALG34

Hi-Flo Air Line Inflator with Single Open Ended Connector

Manufactured and certified to Directive 86/217/EEC **Expert Quality**, industrial quality with single open-ended clip on connector. Suitable for use on garage forecourts and tyre fitting bays. A calibration certificate is supplied with each gauge. Carton packed.

Specification:

| | |
|---------------------|------------------------|
| Pressure range | ... 0-9.6bar/0-138psi |
| Air supply pressure | ... min.6.9bar/100psi |
| | ... max.13.8bar/200psi |
| Supply inlet | ... 1/4" BSP taper (F) |
| Hose length | ... 0.5M (approx.) |

6 foot and 9 foot hoses with single clip on connectors for use with commercial and high pressure tyres are available by special order - contact the Draper Tools Sales Desk for further information.

| Stock No. | Description | Box Qty | Price each |
|-----------|----------------------|---------|------------|
| 30587 | Inflator | - | €108.90P |
| 30770 | Sp. Hose & Connector | - | €37.63D |
| 30773 | Sp. Connector | - | €23.88D |

DRAPER Expert



4 ALG33

Hi-Flo Air Line Inflator with Twin Open Ended Connector

Manufactured and certified to Directive 86/217/EEC **Expert Quality**, industrial quality with twin open-ended hold on connector. Suitable for use on garage forecourts and tyre fitting bays. A calibration certificate is supplied with each gauge. Carton packed.

Specification:

| | |
|---------------------|------------------------|
| Pressure range | ... 0-9.6bar/0-138psi |
| Air supply pressure | ... min.6.9bar/100psi |
| | ... max.13.8bar/200psi |
| Supply inlet | ... 1/4" BSP taper (F) |
| Hose length | ... 0.5M (approx.) |

Hoses are available as optional extras.

| Stock No. | Description | Box Qty | Price each |
|-----------|----------------------|---------|------------|
| 30586 | Gauge | - | €110.58P |
| 30769 | Sp. Hose & Connector | - | €54.85D |
| 30771 | Sp. Connector | - | €23.40D |

STOCKIST INFO
REVISED DEALER
CODES APPLY TO
ITEMS 3, 4 & 5
ON THIS PAGE



1 4288B

Pistol-Grip Air Inflator

Pistol-grip with dial. Suitable for use with motor vehicles, cycles, dinghies, etc. Clip-on connector. Dial reads 0-12bar and 0-170psi (for guidance only). Display packed.

The pressure dial on this model is for guidance only and should be checked with a tyre pressure gauge to BS EN12645:1999

| Stock No. | Box Qty | Price each |
|-----------|---------|------------|
| 10604 | - | €16.35P |



2 4288

Pistol-Grip Air Inflator

Pistol-grip with dial. Suitable for use with motor vehicles, cycles, dinghies, etc. Clip-on connector. Dial reads 0-10bar and 0-140psi. Carton packed.

The pressure dial on this model is for guidance only and should be checked with a tyre pressure gauge to BS EN12645:1999

| Stock No. | Box Qty | Price each |
|-----------|---------|------------|
| 27871 | - | €34.18P |



3 DA12/350D

12V Mini Digital Air Compressor (100psi max.)

Multi-functional compressor with 7 LED light and digital pressure reader (guide only). For the inflating of tyres, dinghies and sports equipment. Powered by 12V cigarette lighter socket. Supplied with 12V DC car cigarette lighter plug on 3M long (approx.) lead and inflating nozzles. Display carton.

The digital pressure reader on this model is for guidance only and should be checked with a tyre pressure gauge to BS EN12645:1999

| Stock No. | Box Qty | Price each |
|-----------|---------|------------|
| 05712 | - | €44.60P |



4 DA12/350A

12V Mini Analogue Air Compressor (100psi max.)

Multi-functional compressor with 7 LED light and analogue pressure dial (guide only). For the inflating of tyres, dinghies and sports equipment. Powered by 12V cigarette lighter socket. Supplied with 12V DC car cigarette lighter plug on 3M long (approx.) lead and inflating nozzles. Display carton.

The analogue pressure dial on this model is for guidance only and should be checked with a tyre pressure gauge to BS EN12645:1999

| Stock No. | Box Qty | Price each |
|-----------|---------|------------|
| 05711 | - | €36.15P |

DRAPER Expert



6 DTG1

Digital Tyre Pressure Reader

Expert Quality, handy-size tyre pressure reader - range 2.0-99.5psi, 0.15-7.00 bar and 15-700kPa. Low power consumption with automatic shut off and powered by a 3V lithium battery (supplied). Display packed.

| Stock No. | Box Qty | Price each |
|-----------|---------|------------|
| 73183 | - | €28.30D |



7 DTG

Digital Tyre Pressure Reader

Handy-size dual-reading tyre pressure reader - range 2-99psi (±1psi) and 0.15-7.99 bar. Low power consumption with automatic shut off and powered by a 3V lithium battery (supplied). Display packed.

| Stock No. | Box Qty | Price each |
|-----------|---------|------------|
| 52304 | - | €19.28D |



8 TPG100A

Tyre Pressure Gauge

Manufactured to BS EN12645:1999

Hand-held dual reading gauge with flexible 250mm long hose. Swivel angled tyre connection and air release valve. Large easy-to-read scale graduated 5-100psi in increments of two psi and 0.5-6bar in increments of 0.1 bar. Display packed.

| Stock No. | Box Qty | Price each |
|-----------|---------|------------|
| 69924 | 12 | €21.23D |



5 DA12/250A

12V Mini Analogue Air Compressor (250psi max.)

Multi-functional compressor with flash light/torch beam and pressure dial (guide only). For the inflating of tyres, dinghies and sports equipment. Powered by cigarette lighter socket. Supplied with 12V DC car cigarette lighter plug on 3M long (approx.) lead, two inflating adaptor nozzles, one needle valve adaptor and hose clip-on tyre adaptor. Display carton.

The pressure dial on this model is for guidance only and should be checked with a tyre pressure gauge to BS EN12645:1999

| Stock No. | Box Qty | Price each |
|-----------|---------|------------|
| 65958 | 6 | €25.48P |



9 TPG101

Tyre Pressure Gauge

Manufactured to BS EN12645:1999

Hand-held dual reading gauge with straight push-on valve chuck. Scale graduated 0-60psi in increments of two psi and 0-4bar in increments of 0.1 bar. Available in the following randomly supplied colours; purple, red, blue, yellow and black. Display packed.

| Stock No. | Box Qty | Price each |
|-----------|---------|------------|
| 69923 | - | €7.35D |

BOX QUANTITY INFORMATION

FOR YOUR CONVENIENCE, WE RECOMMEND ORDERING IN BOX QUANTITY OR MULTIPLES OF BOX QUANTITY WHERE SHOWN. YOU CAN STILL ORDER IN ANY QUANTITY UNLESS SPECIFICALLY STATED OTHERWISE

NEW

1 TPGE

Tyre Pressure Gauge

Dual reading graduated 6-50 psi in increments of one psi and 0.4-3.4 bar in increments of 0.1 bar. In line feature allows access to awkwardly positioned tyre valves. Gauge has valve remover and pocket clip. Display packed.

| Stock No. | Box Qty | Price each |
|-----------|---------|------------|
| 51536 | - | €7.48D |

NEW

2 TPGS

Tyre Pressure Gauge

Pencil type, graduated 6-50 psi in increments of one psi. Gauge has a valve remover and pocket clip. Display packed.

| Stock No. | Box Qty | Price each |
|-----------|---------|------------|
| 51541 | - | €7.48D |



3 30K

Tyre Pressure Gauge

Manufactured to BS EN12645:1999

Dual reading pencil type, graduated 6-50 psi in increments of one psi and 0.4-3.4 bar in increments of 0.1 bar. Gauge has a valve remover and pocket clip. Blue zinc plated and polished finish. Display packed.

| Stock No. | Box Qty | Price each |
|-----------|---------|------------|
| 74308 | - | €16.38D |

DRAPER Expert

4 FP1

Foot Pump

Expert Quality. 450mm (approx) delivery hose with "Lock On" connector for tyres and three accessory nozzles. Foot pump lock to keep closed when not in use. Pressure dial marked 0-100 psi and 0-7 bar. Display carton.

The pressure dial on this model is for guidance only and should be checked with a tyre pressure gauge to BS EN12645:1999

| Stock No. | Box Qty | Price each |
|-----------|---------|------------|
| 22267 | - | €27.28D |



6 4430

Foot Pump

450mm (approx) delivery hose with Lock On" connector for tyres and football inflator adaptor. Pressure dial marked 0-100 psi and 0-7kg/cm² (0-7 bar). Display carton.

The pressure dial on this model is for guidance only and should be checked with a tyre pressure gauge to BS EN12645:1999

| Stock No. | Box Qty | Price each |
|-----------|---------|------------|
| 14172 | 12 | €23.05D |

DRAPER Expert

5 FP2

Double Cylinder Foot Pump

Expert Quality, high performance, suitable for applications where a high volume of air or fast pumping action is required. Pressure dial is marked 0-100 psi and 0-7 bar. Foot pump lock to keep closed when not in use. Supplied with 600mm (approx.) delivery hose with "Lock On" connector for tyres etc. and three accessory nozzles. Display carton.

The pressure dial on this model is for guidance only and should be checked with a tyre pressure gauge to BS EN12645:1999

| Stock No. | Box Qty | Price each |
|-----------|---------|------------|
| 22269 | - | €40.93D |



7 4435

Double Cylinder Foot Pump

Manufactured to GS Specifications

High performance, suitable for applications where a high volume of air or fast pumping action is required.

Pressure dial is marked 0-100 psi and 0-7 bar. Robust all-metal design with 4mm thick steel base. Supplied with 600mm (approx.) delivery hose with "Lock On" connector for tyres etc. and three accessory nozzles. Display carton.

The pressure dial on this model is for guidance only and should be checked with a tyre pressure gauge to BS EN12645:1999

| Stock No. | Box Qty | Price each |
|-----------|---------|------------|
| 25996 | 10 | €38.75D |

8 TL

450mm Tyre Levers

Pair of tyre levers hot forged from EN8 steel hardened, tempered and zinc plated. Carded pair of 2. Display packed.

| Stock No. | Box Qty | Price p/pair |
|-----------|---------|--------------|
| 31495 | - | €38.38D |

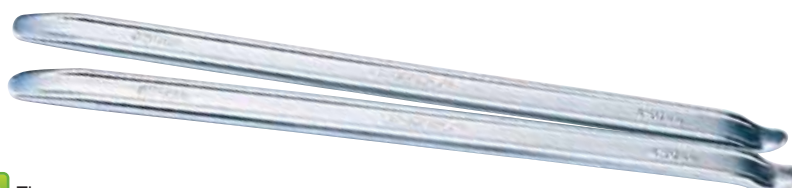



1 TG2

DRAPER Expert

Digital Tyre Tread Depth Gauge with Stainless Steel Body

Expert Quality, metric and imperial calibration with conversion between the two. Zero setting control allows for comparative measurement. Clear LCD for easy reading. Measuring range 0-25mm/0-1"; resolution 0.01mm/0.0005"; accuracy ±0.05mm/0.0001". Supplied with SR44 battery. Display packed.

| Stock No. | Description | Box Qty | Price each |
|-----------|------------------------|---------|------------|
| 39591 | Tyre Tread Depth Gauge | - | €40.88D |
| 55361 | Spare SR44 Battery | - | €4.38D |



2 TG1

Digital Tyre Tread Depth Gauge with Plastic Body

Metric and imperial calibration with conversion between the two. Zero setting control allows for comparative measurement. Clear LCD for easy reading. Measuring range 0-25mm/0-1"; resolution 0.01mm/0.0005"; accuracy ±0.1mm/0.0001". Supplied with SR44 battery. Display packed.

| Stock No. | Description | Box Qty | Price each |
|-----------|------------------------|---------|------------|
| 39590 | Tyre Tread Depth Gauge | - | €21.15D |
| 55361 | Spare SR44 Battery | - | €4.38D |



3 TG92

APPROVED FOR USE IN UK MOT BAYS

Tyre Tread Depth Gauge

Complies with EC Directive 89/459/EEC

Gives fast and easy-to-read measurement of tyre tread depth from 1-26mm in one millimetre graduations on sliding barrel. Includes a 1.6mm graduation to comply with MoT minimum tyre tread depth requirement. Accepted in the UK by the Department of Transport for MOT Testing. Plated steel body with pocket clip. Display packed.

| Stock No. | Box Qty | Price each |
|-----------|---------|------------|
| 27298 | 6 | €7.48D |

1.6mm TYRE TREAD DEPTH

This is the current legal minimum for the central three-quarters of the tread around the entire circumference of the tyre.



NEW

4 TSK3

3 piece Tyre Service Kit

Kit comprising of Tyre Tread Depth Gauge Stock No.27298 also Tyre Pressure Gauge Stock No.51581 and Stock No.51548 Tyre Valve Repair Tool. Display packed.

| Stock No. | Box Qty | Price per kit |
|-----------|---------|---------------|
| 51550 | - | €16.23D |



5 TVRT

Tyre Valve Repair Tool

Cleans internal and external valve stem threads and removes valve cores. Display packed.

| Stock No. | Box Qty | Price each |
|-----------|---------|------------|
| 51548 | - | €4.98D |

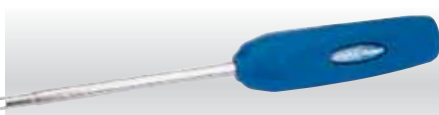

6 TVTS1

Tyre Valve Torque Driver

Expert Quality, allows replacement of Schrader valve cores to the correct torque. Important on vehicles with Tyre Pressure Monitoring Systems (TPMS). Max torque 0.45Nm. Display packed.

| Stock No. | Length | Box Qty | Price each |
|-----------|--------|---------|------------|
| 46795 | 150mm | 12 | €17.28D |



7 TPMS-1

TPMS Valve Deflator Tool

Expert Quality, allows the user to deflate tyres with tyre pressure monitoring system (TPMS) for replacement or repair with no damage to the sensitive sensor. Each deflator is colour coded and stamped for easy indication of individual tyre location, essential in preventing problems when re-fitting. Display packed.

| Stock No. | Box Qty | Price each |
|-----------|---------|------------|
| 22487 | 10 | €34.10D |



8 WWP1

250mm Wheel Balance Weight Pliers

For fitting, removing and cutting vehicle wheel weights. Drop forged carbon steel hardened, tempered, heat treated and plated finish for corrosion protection. PVC dipped handles. Display packed.

| Stock No. | Box Qty | Price each |
|-----------|---------|------------|
| 56748 | 2 | €21.78D |



9 WSRK/C

Car Wheel Stud Repair Kit

Unique design enabling restoration of damaged wheel stud threads. The two-piece split dies require attaching to the "good" section of the stud and with the supplied adaptor the thread can be reinstated from the bottom preventing the creation of double threads which can occur when repaired from the top of the stud. Supplied with 3 dies, adaptor, 2 retainer o-rings and a shock resistant plastic case. Display packed.

| Stock No. | Box Qty | Price each |
|-----------|---------|------------|
| 38399 | - | €40.63D |



10 WSRK/HGV

HGV Wheel Stud Repair Kit

Expert Quality, unique design enabling restoration of damaged wheel stud threads. The two-piece split dies require attaching to the "good" section of the stud and with the supplied adaptor the thread can be reinstated from the bottom preventing the creation of double threads which can occur when repaired from the top of the stud. Supplied with 4 dies, adaptor, 2 retainer o-rings and a shock resistant plastic case. Display packed.

| Stock No. | Box Qty | Price each |
|-----------|---------|------------|
| 38401 | - | €84.98D |

STOCKIST INFO
REVISED DEALER
CODES APPLY TO
ITEMS 4 & 5
ON THIS PAGE

BOTTLE JACKS

A wide selection of bottle jacks are shown on page 152.

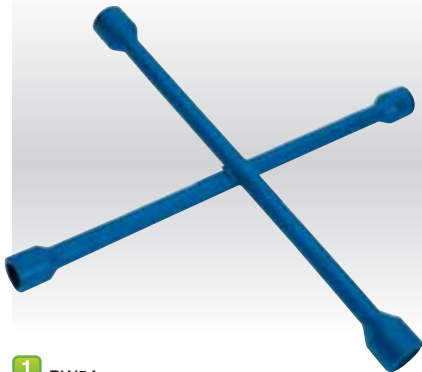

1 PW5A

Four Way Wheel Nut Wrench

Heavy duty forged four way wheel nut wrench 17 x 19 x 21 x 22mm. Enamelled finish for corrosion protection. Arm length: 380mm. Sold loose.

| Stock No. | Box Qty | Price each |
|-----------|---------|------------|
| 36005 | - | €15.03D |

NEW

DRAPER Expert

1/2" SQ.DRIVE



4 LWNS4-B

4 piece 1/2" Sq. Dr. Locking Wheel Nut Set

Expert Quality, for the installation and removal of locking wheel nuts on most vehicles (except those fitted with rotating protector shrouds). Manufactured from molybdenum steel, hardened, tempered and chemically blacked for corrosion protection. Reduce tapered internal left hand coarse thread. For use with air and electric tools. Supplied with metal case. Display packed. Contents: 38mm long x 17.0, 18.5, 21.5 and 26.0mm (open end)

| Stock No. | Box Qty | Price per set |
|-----------|---------|---------------|
| 34032 | - | €35.23H |

NEW

DRAPER Expert

1/2" SQ.DRIVE

Draper Expert HI-TORQ®
6 point



5 AWNS/3A

1/2" Sq. Dr. Draper Expert HI-TORQ® Wheel Nut Sockets for Alloy Wheels

Expert Quality, set of three 6 point Draper Expert HI-TORQ® sockets sizes 17, 19 and 21mm. Manufactured from chrome molybdenum. Fitted with internal and external nylon sleeve preventing damage to wheels and nuts when in use. Supplied in handy case.

| Stock No. | Box Qty | Price per set |
|-----------|---------|---------------|
| 30630 | - | €32.76H |

NEW

DRAPER Expert

1/2" SQ.DRIVE

Draper Expert HI-TORQ®
6 point



6 AWNS/17MM

17mm 1/2" Sq. Dr. Draper Expert HI-TORQ® Wheel Nut Socket for Alloy Wheels

Expert Quality, 6 point Draper Expert HI-TORQ® 17mm socket. Manufactured from chrome molybdenum. Sleeved with nylon internally and externally preventing damage to wheels and nuts when used. Display packed.

| Stock No. | Box Qty | Price each |
|-----------|---------|------------|
| 30631 | - | €13.74D |

NEW

DRAPER Expert

1/2" SQ.DRIVE

Draper Expert HI-TORQ®
6 point



7 AWNS/19MM

19mm 1/2" Sq. Dr. Draper Expert HI-TORQ® Wheel Nut Socket for Alloy Wheels

Expert Quality, 6 point Draper Expert HI-TORQ® 19mm socket. Manufactured from chrome molybdenum. Sleeved with nylon internally and externally preventing damage to wheels and nuts when used. Display packed.

| Stock No. | Box Qty | Price each |
|-----------|---------|------------|
| 30638 | - | €13.74D |

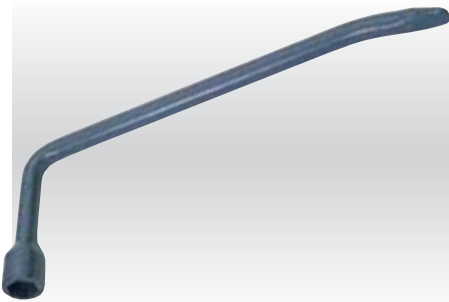

2 S21

Wheel Nut Wrench

Heavy duty forged wrench with long, high leverage handle incorporating a 3/4" AF-19mm (dual size) socket and hub cap remover. Enamelled finish for corrosion protection. Sold loose.

| Stock No. | Box Qty | Price each |
|-----------|---------|------------|
| 07054 | 10 | €11.03D |

NEW

DRAPER Expert

1/2" SQ.DRIVE

Draper Expert HI-TORQ®
6 point



8 AWNS/21MM

21mm 1/2" Sq. Dr. Draper Expert HI-TORQ® Wheel Nut Socket for Alloy Wheels

Expert Quality, 6 point Draper Expert HI-TORQ® 21mm socket. Manufactured from chrome molybdenum. Sleeved with nylon internally and externally preventing damage to wheels and nuts when used. Display packed.

| Stock No. | Box Qty | Price each |
|-----------|---------|------------|
| 30640 | - | €14.69D |

NEW

DRAPER Expert

1/2" SQ.DRIVE

Draper Expert HI-TORQ®
6 point



9 AWNS/22MM

22mm 1/2" Sq. Dr. Draper Expert HI-TORQ® Wheel Nut Socket for Alloy Wheels

Expert Quality, 6 point Draper Expert HI-TORQ® 22mm socket. Manufactured from chrome molybdenum. Sleeved with nylon internally and externally preventing damage to wheels and nuts when used. Display packed.

| Stock No. | Box Qty | Price each |
|-----------|---------|------------|
| 30646 | - | €14.69D |



3 WM17/19

Extending Wheel Nut Wrench

Supplied with two 1/2" sq. drive reversible sockets size 17 x 19 and 21 x 22mm, manufactured from chrome vanadium steel. Handle extends to 525mm which helps to increase torque on difficult wheel nuts. Display packed.

| Stock No. | Box Qty | Price each |
|-----------|---------|------------|
| 19152 | - | €31.80D |



1 BR4/KIT

4 tonne Hydraulic Body Repair Kit

For use in the garage or bodyshop. Contents: • (A) 5 x Extension Bars 495, 420, 215, 100 and 85mm • (B) Serrated Cap • (C) Hydraulic Spreading Wedge • (D) Rubber Head 60mm diameter • (E) Flat Serrated Base • (F) Ram Toe • (G) Plunger Toe • (H) Cleft Head • (J) "V" Base • (K) Double End Male Snap Connector • (L) 4 Tonne Pump Unit and Hose • (M) Hydraulic Push Ram - length 330mm
Packed in sturdy steel case with styrofoam insert.

| Stock No. | Weight | Box Qty | Price per kit |
|-----------|--------|---------|---------------|
| 37874 | 22.5kg | - | €183.50P |



2 BR10/KIT

10 tonne Hydraulic Body Repair Kit

For use in the garage or bodyshop. Contents: • (A) 4 x Extension Bars 685, 455, 250, and 100mm • (B) Serrated Cap • (C) Hydraulic Spreading Wedge • (D) Rubber Head 80mm diameter • (E) Flat Serrated Base • (F) Ram Toe • (G) Plunger Toe • (H) Cleft Head • (J) "V" Base • (K) Double End Male Snap Connector • (L) 10 Tonne Pump Unit and Hose • (M) Hydraulic Push Ram - length 470mm
Packed in sturdy steel case with styrofoam insert.

| Stock No. | Weight | Box Qty | Price per kit |
|-----------|--------|---------|---------------|
| 37875 | 38kg | - | €285.88P |



3 SH/KIT

Slide Hammer Kit

Packed in blow mould storage carrying case with display sleeve. Contents: • 2.3kg slide hammer with 470mm shaft • M16 x 1.5 threaded end for attachments • large flat hook • small flat hook • large round hook • small round hook • screwdriver • self-tapping screw • tapered screw • adaptor

| Stock No. | Box Qty | Price per kit |
|-----------|---------|---------------|
| 52321 | - | €73.70D |

NEW

DRAPER Expert



4 PTG1250

Ultrasonic Paint Thickness Gauge

Expert Quality, vehicle paint thickness gauge, useful for professional bodyshop technicians, car sales personnel and for use in vehicle assessments. Uses ultrasonic technology to quickly and accurately read the thickness of paint providing evidence of accident repair. Display packed.

| Stock No. | Box Qty | Price each |
|-----------|---------|------------|
| 43620 | - | €236.25P |



5 BHS

Brake and Headlight Spring Hook

Ideal for removal and installation of hard to reach brake and headlight springs. Manufactured from heat treated alloy steel and chemically blacked for corrosion protection. Display packed

| Stock No. | Box Qty | Price each |
|-----------|---------|------------|
| 24317 | - | €13.63D |

MOT HAMMER

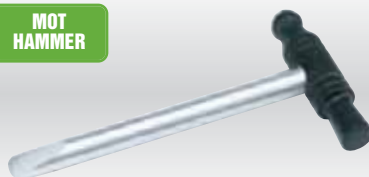

6 CAT47

Corrosion Assessment Tool

Expert Quality, combination tapping hammer, blunt scraper and short lever for checking corrosion levels in bodywork, panels and chassis. Suitable for use in MOT bays. Display packed.

| Stock No. | Length | Box Qty | Price each |
|-----------|--------|---------|------------|
| 69721 | 140mm | - | €18.33D |

DRAPER Expert

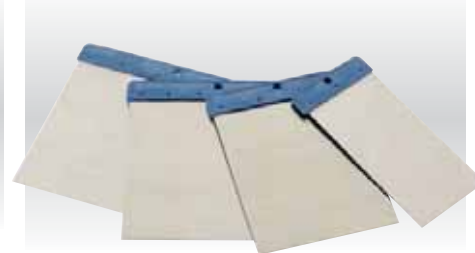

7 BFAS

4 piece Body Filler Applicator Set

Spring steel with plastic header grips. Ideal for use on vehicles and around the home. Display packed. Contents: 50, 80 100 and 120mm wide applicators

| Stock No. | Box Qty | Price per set |
|-----------|---------|---------------|
| 44100 | 10 | €4.15D |



DRAPER Expert

1 ITK-2
12 piece Trim Removal Kit

Expert Quality, for the removal and manipulation of interior trims i.e. door panels, dashboard fascias, trim strips and other similar applications in the automotive, marine and aviation industries. Comprises 12 special non-marking nylon tools that fulfil specific requirements, all in a heavy duty canvas compartment tool roll with hook and loop fixing. Display carton.

| Stock No. | Box Qty | Price per kit |
|-----------|---------|---------------|
| 22492 | - | €41.73D |



NEW

DRAPER Expert

5 ATP
Automotive Trim Removal Pliers

Expert Quality, spring-loaded pliers fitted with bump stops and wide 32mm head that helps eliminate pinpoint pressure and damage when removing automotive trim. Manufactured from heat-treated carbon steel. The ideal tool for removing delicate trims. Display packed.

| Stock No. | Box Qty | Price each |
|-----------|---------|------------|
| 28819 | 6 | €17.44D |



6 HRPAF

210mm Hog Ring Pliers

DRAPER Expert

Expert Quality, for use with hog rings used in vehicle interiors, upholstery and fencing applications. Automatic feed for one hand operation. Soft grip handles for user comfort. Supplied with 100 hog rings. Display packed.

| Stock No. | Description | Box Qty | Price each |
|-----------|--------------------|---------|------------|
| 26317 | Pliers | - | €68.08D |
| 28320 | Hog Rings (300pcs) | - | €6.80D |



2 176
Door Panel Removal Tool

For break-free door panel clip removal. Display packed.

| Stock No. | Box Qty | Price each |
|-----------|---------|------------|
| 19193 | 10 | €7.75D |



DRAPER Expert

3 TL400
400mm Multi-Purpose Trim Lever

Expert Quality, multi-purpose lever suitable for the manipulation of trim and fixings in the automotive, marine, aviation and bathroom environments. Manufactured from ultra tough high quality nylon. Display packed.

| Stock No. | Box Qty | Price each |
|-----------|---------|------------|
| 24310 | - | €32.00D |

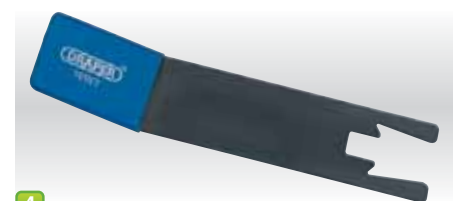

4 WWT
Window Winder Clip Removal Tool

For the removal and installation of the spring clips used on window winder handles fitted on GM (Vauxhall/Opel) models. Can also be used on other vehicles with similar configurations. Manufactured from spring steel and chemically blacked with PVC dipped handle. Display packed.

| Stock No. | Box Qty | Price each |
|-----------|---------|------------|
| 52580 | - | €7.20D |

CAR RADIO REMOVAL KEY KITS

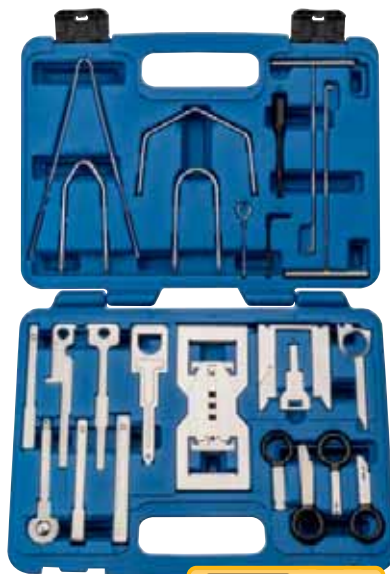

DRAPER Expert

7 RRTK46
46 piece Car Radio Removal Key Kit

Expert Quality, selection of keys for the efficient removal of console and dashboard mounted radio/CD/MP3 and DVD players by garages, emergency services and specialist car audio installers. Can also be used with most sat nav and DVD screens. Suitable for use with Audi, BMW, Fiat, Ford, GM (Vauxhall/Opel), Mercedes, Porsche, Skoda and Volkswagen vehicles and the following audio equipment. Blaupunkt from 2002; Clarion; Clarion (ALT); Grundig; JVC; Kenwood II 1998-2001; Kenwood III from 2002; Pioneer; Sony I pre 2001; Sony II from 2002. Supplied in blow mould case with display sleeve.

These kits should only be sold to bona fide garages, emergency services and specialist car audio installers

| Stock No. | Box Qty | Price per kit |
|-----------|---------|---------------|
| 43797 | - | €136.83D |



DRAPER Expert

8 RRTK18
18 piece Car Radio Removal Kit

Expert Quality, selection of keys to allow the removal of car radios by garages, emergency services and specialist car audio installers. Contained in plastic wallet for security. Display packed.

Contents: • pair of cylindrical keys for VW/Audi/Ford vehicles and Blaupunkt/Grundig radios • BMW pentagon key • set of four keys for VW/Audi/Mercedes vehicles and Becker radios • pair of keys for Porsche/Mercedes vehicles and Becker radios • pair of VW keys • BMW/Vauxhall 2mm hexagon key • 2 x Becker pressed steel keys • pair of Skoda keys • pair of Blaupunkt wide spaced cylindrical keys

These kits should only be sold to bona fide garages, emergency services and specialist car audio installers

| Stock No. | Box Qty | Price per kit |
|-----------|---------|---------------|
| 89792 | - | €42.50D |

PRODUCT INFORMATION

Every effort has been made to ensure that the applications shown in this Draper Tools Catalogue are accurate and include all the current car/van models. When using specialized automotive tools ALWAYS refer to the vehicle manufacturer's service or relevant Haynes manual for detailed and concise instruction of usage.

DAVE SAYS

QUALITY MAKES THE DIFFERENCE

DAVE SAYS

IMPORTANT WINDSCREEN INFORMATION

When driving, a clean and clear windscreen is essential for good vision, but the windscreen is far more than just a piece of glass for keeping the wind and rain out. A bonded windscreen is a vital component of the vehicle's body shell and adds significantly towards its overall strength and rigidity. With this in mind it's essential for all windscreen and automotive technicians to choose the right tools when replacing windscreens. You can be sure you're using the right tools when you choose any Draper tool.

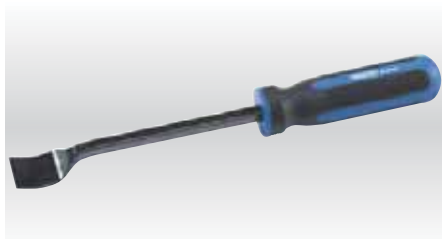

1 TRT

Windscreen (Christmas Tree) Moulding Removal Tool

Expert Quality, broad flat head helps eliminate deformation of the christmas tree moulding or damage to the windscreen during removal or replacement. Useful for door trim/interior trim removal. Soft grip handle for user comfort. Display packed.

| Stock No. | Box Qty | Price each |
|-----------|---------|------------|
| 23237 | - | €10.50D |

DRAPER Expert



2 WRT

Bonded Windscreen Removal Tool

For the removal of bonded windscreens fitted to motor vehicles. The blade cuts the adhesive caulking compound around the windscreen using the specially hardened carbon steel blade. Body length 163mm. Supplied with 25mm blade. Spare blades available - see entry below. Sold loose.

| Stock No. | Description | Box Qty | Price each |
|-----------|--------------------|---------|------------|
| 35098 | Removal Tool | 6 | €24.93D |
| 65537 | Spare Blade - 19mm | - | €5.45D |
| 38016 | Spare Blade - 25mm | - | €5.45D |
| 65538 | Spare Blade - 31mm | - | €5.45D |

LEGAL INFORMATION - KNIVES

WARNING - Knives or other articles with a blade or sharp point must not be sold to persons underage. It's the law! (Offensive Weapons Act 1996 and the Violent Crime Act 2006).



WINDSCREEN REMOVAL KNIVES

3 UWK

Windscreen Removal Knives

Expert Quality, for use on vehicles with deep dashboard or where bonding is out of reach to normal length tools. Manufactured from lightweight aluminium with integrated spare blade storage compartment. Supplied with standard two notch trimming knife blade. Display packed.

| Stock No. | Length | Box Qty | Price each |
|-----------|------------------|---------|------------|
| 23249 | 450mm | - | €24.55D |
| 23250 | 600mm | - | €27.28D |
| 13499 | Pack of 5 blades | 10 | €1.95D |

DRAPER Expert



4 WST5

Pair of Handles for Windscreen Bond Cutting Wire

Expert Quality, suitable for use with windscreen bond cutting wire Stock Nos. 65547 and 65548 or other manufacturers similar bond cutting wire. Manufactured from reinforced resin with soft grip handle and 'quick release' wire clamp. Display packed.

| Stock No. | Box Qty | Price per pair |
|-----------|---------|----------------|
| 69730 | - | €52.20D |

DRAPER Expert

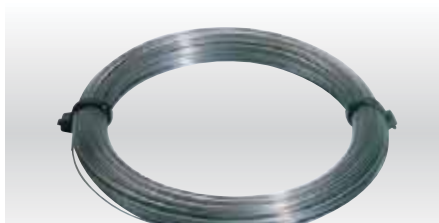

5

22.5M Stainless Steel Windscreen Bond Cutting Wire

For cutting the adhesive caulking compound around bonded windscreens. Available as either standard or braided wire. Sold loose.

| Stock Part No. | Wire Description | Box Qty | Price each |
|----------------|------------------|---------|------------|
| 65547 WST2 | Square 0.5/0.6mm | - | €21.48D |
| 65548 WST12 | Braided 0.8mm | - | €26.35D |

6 WS2

Window Scraper

Expert Quality, stainless steel with resin handle. For removal of stubborn adhesives etc. Particularly useful for bonded windcreens. Supplied with one double-sided blade 38mm wide. Spare blades in pack of 12 available - Stock No.65545. Display packed.

| Stock No. | Description | Box Qty | Price each |
|-----------|-------------|---------|------------|
| 65543 | Scraper | - | €23.55D |
| 65545 | 12 blades | - | €6.90D |

DRAPER Expert

BOX QUANTITY INFORMATION

FOR YOUR CONVENIENCE, WE RECOMMEND ORDERING IN BOX QUANTITY OR MULTIPLES OF BOX QUANTITY WHERE SHOWN. YOU CAN STILL ORDER IN ANY QUANTITY UNLESS SPECIFICALLY STATED OTHERWISE



DAVE SAYS

SUCTION LIFTERS

Essential for the windscreen industry, but also for carrying plate glass. The twin lifters are the ideal tool for automotive applications as illustrated right.



1 SCDP1

Suction Cup/Dent Puller

Thick rubber pad with plastic handles. Maximum capacity 20kg. safe working load 10kg. Display carton.

| Stock No. | Diameter | Box Qty | Price each |
|-----------|----------|---------|------------|
| 69187 | 118mm | - | €7.43D |



2 SUC2

Twin Suction Lifter

Expert Quality, for the easy lifting of smooth flat surface materials, i.e. glass, marble etc. Suction cups 123mm diameter. Maximum lift 50kg; safe working load (S.W.L.) 25kg. Manufactured from high density aluminium alloy. Display packed.

| Stock No. | Box Qty | Price each |
|-----------|---------|------------|
| 69723 | - | €74.40D |



3 SCDP2

Twin Suction Lifter

For the easy lifting of smooth flat surface materials, i.e. glass, marble etc. Manufactured from tough plastic with rubber suction cups. Suction cups 118mm diameter. Maximum lift 40kg; safe working load (S.W.L.) 20kg. Display packed.

| Stock No. | Box Qty | Price each |
|-----------|---------|------------|
| 71172 | - | €20.58D |



4 SUC3

Triple Suction Lifter

Expert Quality, for the easy lifting of smooth flat surface materials, i.e. glass, marble etc. Suction cups 123mm diameter. Maximum lift 75kg; safe working load (S.W.L.) 37.5kg. Manufactured from high density aluminium alloy. Display packed.

| Stock No. | Box Qty | Price each |
|-----------|---------|------------|
| 69724 | - | €111.85D |



5 SCDP3

Triple Suction Lifter

For the easy lifting of smooth flat surface materials, i.e. glass, marble etc. Manufactured from tough plastic with rubber suction cups. Suction cups 118mm diameter. Maximum lift 60kg; safe working load (S.W.L.) 30kg. Display carton.

| Stock No. | Box Qty | Price each |
|-----------|---------|------------|
| 43846 | - | €28.78D |



6 SCDP4

Quad Suction Lifter

For the easy lifting of smooth flat surface materials, i.e. glass, marble etc. Manufactured from tough plastic with rubber suction cups. Suction cups 118mm diameter. Maximum lift 80kg; safe working load (S.W.L.) 40kg. Display carton.

| Stock No. | Box Qty | Price each |
|-----------|---------|------------|
| 43847 | - | €38.38D |



7 WST6

Windscreen Wiper Arm Removal Tool

Expert Quality, for the safe and efficient removal of windscreen wiper arms. Avoids damage to vehicle bodywork or wiper assembly. Zinc plated for corrosion protection. Display packed.

| Stock No. | Box Qty | Price each |
|-----------|---------|------------|
| 71462 | - | €22.98D |



8 WNT

Vehicle Washer Jet Cleaning Tool

Expert Quality, knurled body with pocket clip, needle point one end and scribe point on the other. For cleaning and repositioning of vehicle washer jets. Supplied with end caps to prevent personal injury when not in use. Display packed.

| Stock No. | Length | Box Qty | Price each |
|-----------|--------|---------|------------|
| 03322 | 95mm | - | €7.93D |



DRAPER Expert

1 WC-01

Car Front Wing Cover

Expert Quality, to protect vehicle bodywork from scratches and spillages whilst undergoing routine maintenance. Fixes to wing with built-in magnetic strips. Half moon cut-out for wheel arch exposure. Wipe clean outer with polypropylene inner. Display packed.

| Stock No. | Size | Box Qty | Price each |
|-----------|-------------|---------|------------|
| 22592 | 820 x 640mm | - | €36.83D |



2 WC-02

Car Front Wing Cover

Protects vehicle bodywork from scratches and spillages whilst undergoing routine maintenance. Fixes to wing with built-in magnetic strips. Half moon cut-out for wheel arch exposure. Washable waterproof polypropylene. Display packed.

| Stock No. | Size | Box Qty | Price each |
|-----------|-------------|---------|------------|
| 22594 | 820 x 640mm | - | €27.28D |



3 SCREEN-02

Windscreen Cover

Protects vehicle windscreen, wing mirrors and front side windows from frost, ice and snow. Washable polypropylene with fastening straps to wheel or wheel arch. Display packed.

| Stock No. | Box Qty | Price each |
|-----------|---------|------------|
| 22606 | - | €35.45D |

VEHICLE PROTECTION AND SEAT COVERS

To protect a vehicle's bodywork, it's advisable that when servicing or working on the engine always use protective covers so tools don't scratch or damage the paintwork.



DRAPER Expert

4 SC-03

Side Airbag Compatible Heavy Duty Front Seat Cover

Expert Quality, suitable for car and van single seats fitted with side airbags. Protects from mud, oil, grease, sweets and other sticky substances. Washable with polypropylene inner and straps to secure cover to seat. Aperture for side airbags. Display packed.

| Stock No. | Size | Box Qty | Price each |
|-----------|--------------|---------|------------|
| 22597 | 1380 x 650mm | - | €25.28D |



6 SC-01

Side Airbag Compatible Polypropylene Economy Front Seat Cover

Suitable for car and van single seats fitted with side airbags. Protects from mud, oil, grease, sweets and other sticky substances. Washable polypropylene with straps to secure cover to seat. Aperture for side airbags. Display packed.

| Stock No. | Size | Box Qty | Price each |
|-----------|--------------|---------|------------|
| 22595 | 1360 x 660mm | - | €13.63D |



5 SC-02

Side Airbag Compatible Polyester Front Seat Cover

Suitable for car and van single seats fitted with side airbags. Protects from mud, oil, grease, sweets and other sticky substances. Washable polyester with straps to secure cover to seat. Aperture for side airbags. Display packed.

| Stock No. | Size | Box Qty | Price each |
|-----------|--------------|---------|------------|
| 22596 | 1300 x 660mm | - | €17.08D |

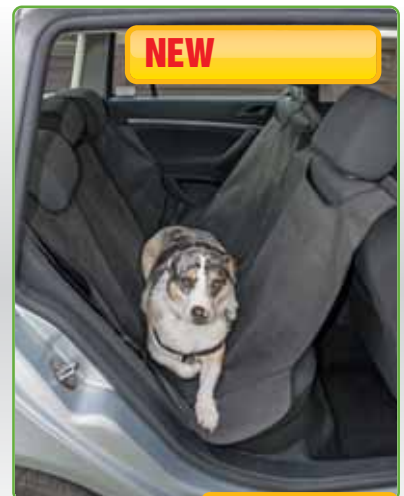

NEW

DRAPER Expert

7 SC-DOG

Heavy Duty Rear Seat Cover

Expert Quality, suitable for car and van back seats. Protects from mud, oil, grease, sweets and other sticky substances, especially useful in protecting the rear seats from the water, mud, hair, food etc; trailed into the car by dogs. Washable with polypropylene inner and straps to secure cover to seat. Display packed.

| Stock No. | Box Qty | Price each |
|-----------|---------|------------|
| 42412 | - | €42.23D |



1 FSDK
9 piece Motorcycle Fork Seal Driver Kit

Expert Quality, split design allows simple use on conventional or inverted forks. Zinc plated carbon steel hardened and tempered with knurled ring for extra grip. Comprises split drivers size: 35-36mm, 39mm, 41mm, 43mm, 45mm, 46-47mm, 48mm. 49-50mm and 54mm. Packed in blow mould case with display sleeve.

| Stock No. | Box Qty | Price per kit |
|-----------|---------|---------------|
| 04500 | - | €300.98P |



2 CBRK3
Motorcycle Chain Splitter and Riveter Kit

Expert Quality, for splitting chains from No.25 cam chains through to No.520 motorcycle final drive chains. Please note, to successfully press the rivet from heavy duty 520 drive chains, the rivet head must be ground off first. Display packed in blow mould storage case.

Contents: • Main press body, clamp and pressure screw handle • Sliding tee bar • Two press plates • Two press anvils • 2.2, 2.9 and 3.8mm press pins • Rivet tip spreader • Upper and lower guides for 2.2 mm press pin • Spring for press pins

| Stock No. | Box Qty | Price per kit |
|-----------|---------|---------------|
| 31318 | - | €66.05P |

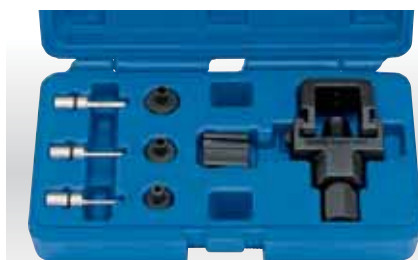

3 CBRK5
Motorcycle Chain Splitter and Riveting Kit

Expert Quality, splitter and chain riveter kit hardened and tempered to withstand the rigors of workshop use. Designed for splitting and re-riveting motorcycle chains between the range 520 - 530 and chains 420 and 428. Packed in blow mould case.

Contents: 1 x chain plate guide, 1 x 3mm rivet pin guide, 1 x 3mm rivet pin, 1 x 4mm rivet pin guide, 1 x 4mm rivet pin, 1 x 5mm rivet pin guide and 1 x 5mm rivet pin.

| Stock No. | Box Qty | Price per kit |
|-----------|---------|---------------|
| 12921 | - | €126.43P |

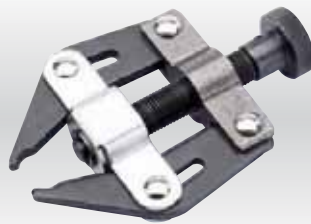

4 MCT
Motorcycle Chain Tensioner

Expert Quality, holds chain ends at correct distance apart when replacing split link. Suitable for most chain sizes including 425, 520, 528 and 530. Display packed.

| Stock No. | Box Qty | Price each |
|-----------|---------|------------|
| 30827 | - | €26.00D |

3/8" SQ.DRIVE



6 MCSK4
Motorcycle Spindle Key

Expert Quality, for the removal of hollow wheel spindles. Hexagon sizes on tool: 17, 19, 22, 24mm with internal 3/8" square drive in the 19mm hex end. Display packed.

| Stock No. | Box Qty | Price each |
|-----------|---------|------------|
| 30831 | - | €30.45D |



8 MBPP1
240mm Motorcycle Brake Piston Pliers

Expert Quality, for the removal of seized pistons without damaging outer piston surface. Knurled clamp blocks allow secure grip of inner piston face. Self-locking mechanism ensures tight grip on piston during removal. Display packed.

| Stock No. | Capacity Diameter | Box Qty | Price each |
|-----------|-------------------|---------|------------|
| 30838 | 19-36mm | - | €39.20D |

3/8" SQ.DRIVE



10 OFW
Motorcycle Oil Filter Wrenches

Expert Quality, with flexible steel band to securely clamp filter. Design allows easy access to restricted area. Driven by 3/8" square drive recess. Display packed.

| Stock No. | For Filter Diameter | Box Qty | Price each |
|-----------|---------------------|---------|------------|
| 30829 | 71-79mm | 12 | €11.03D |
| 30828 | 87-95mm | 12 | €11.88D |



5 CCK
Motorcycle Chain Cleaning Kit

For cleaning of motorcycle chains whilst in-situ. Comprises bottle for holding cleaning fluid, plastic tube, Y piece adaptor and chain bath with cleaning brushes. Easy set up; bath is clamped over chain and the bottle connected to bath via plastic tubes and chain cleaned. Waste fluid is then drained away. Display carton.

| Stock No. | Box Qty | Price per kit |
|-----------|---------|---------------|
| 30834 | - | €62.85D |



7 MWS
Motorcycle Wheel Spinner

For manual spinning of motorcycle wheels during routine maintenance. Wheel sits in cradle and it can be rotated whilst motorcycle is stationary. Rubber insert in base to stabilize unit when using. Display carton.

| Stock No. | Box Qty | Price each |
|-----------|---------|------------|
| 30837 | - | €48.88D |



9 CWB/MC
Motorcycle Brake Piston Tool

Expert Quality, for the simple and controlled retraction of hydraulic brake pistons when replacing front or rear brake pads. Dual thickness pad fingers for ease of access. Display packed.

| Stock No. | Box Qty | Price each |
|-----------|---------|------------|
| 30826 | - | €94.38D |



11 MODP
Motorcycle Oil Drain Pan

Slimline design to allow easy access for use with motorcycles and oil changes for small engines. High density polyethylene, resistant to most chemicals and solvents. Ribbed surface to aid drainage. Sold loose.

| Stock No. | Box Qty | Price each |
|-----------|---------|------------|
| 04265 | - | €14.60D |

BREAKDOWN AND RECOVERY



1 RPP 1000kg Power Puller

Manufactured to GS Specifications

Suitable for pulling heavy objects such as cars, boats, logs, etc. Two steel gears with twin locking pawls. An extension cable 6M long x 6mm dia. is available as is a spare cable assembly - see entry. Display carton.

Specification:

Capacity - pulling ... 1 tonne (1000kg)
Capacity - breaking ... 2 tonne (2000kg)
Cable diameter ... 5mm

| Stock No. | Description | Box Qty | Price each |
|-----------|----------------|---------|------------|
| 51934 | Puller | - | €53.75P |
| 52220 | Cable Assembly | - | €23.55D |



2 WRP1 Wire Rope Hoist/Winch

DRAPER Expert

Expert Quality, adaptable drumless hoist/winch designed for lifting or pulling. Supplied with handle and 20M of wire rope with hook. Spare lengths of wire rope available. Carton packed.

Specification:

Lifting capacity ... 1600kg
Pulling capacity ... 2400kg
Wire Rope ... 11mm dia.
Overall size ... 545 x 284 x 97mm
Weight ... 12kg

| Stock No. | Description | Box Qty | Price each |
|-----------|-------------------------|---------|------------|
| 71208 | Wire Rope Hoist/Winch | - | €285.68P |
| 71353 | 20M Wire Rope with hook | - | €168.50D |



3 RW/12V-1134KGS 1134kg 12V Recovery Winch

DRAPER Expert

Expert Quality, for mounting on vehicles or trailer beds. Steel all-weather fabrication and high power DC motor gives first class pulling power. Fitted with gear-train for smooth quiet operation and longer working life. Remote control can be hand held or fitted to vehicle allowing power to be controlled from a safe working distance. High quality wire rope fed through 4-way roller gives smooth and even distribution of cable on to drum helping prevent line kink. Carton packed.

Specification:

Voltage ... 12V DC
Capacity - pulling ... 1134kg
Motor power ... 700W
Cable diameter ... 5mm
Cable length ... 14M (approx.)
Weight ... 9.5kg

| Stock No. | Box Qty | Price each |
|-----------|---------|------------|
| 24441 | - | €249.98P |



4 KW/12V-1814KGS 1814kg 12V Recovery Winch

DRAPER Expert

Expert Quality, for mounting on vehicles or trailer beds. Steel all-weather fabrication and high power DC motor gives first class pulling power. Fitted with gear-train for smooth quiet operation and longer working life. Remote control can be hand held or fitted to vehicle allowing power to be controlled from a safe working distance. High quality wire rope fed through 4-way roller gives smooth and even distribution of cable on to drum helping prevent line kink. Carton packed.

Specification:

Voltage ... 12V DC
Capacity - pulling ... 1814kg
Motor power ... 1200W
Cable diameter ... 5.5mm
Cable length ... 15M (approx.)
Weight ... 9.5kg

| Stock No. | Box Qty | Price each |
|-----------|---------|------------|
| 24443 | - | €312.45P |



5 RW/KIT Recovery Winch Accessory Kit

DRAPER Expert

Expert Quality, all-in-one kit for off-road recovery for use with electric or hand operated winches. Used for towing only. Carton packed. Contents: • Snatch block • 2 x Bow type shackle • 2M nylon sling (SWL 1814kg) • Canvas holdall • Pair of heavy duty gloves

| Stock No. | Box Qty | Price per kit |
|-----------|---------|---------------|
| 24444 | - | €124.98P |

7 SS1000/2 Folding Steel Shovel

Carbon steel serrated blade with tubular steel handle. Powder coated to prevent corrosion. Handle is tightened by integral collet - so no need for additional tools. Supplied with vinyl pouch for storage. Display packed.

| Stock No. | Min. Length | Max. Length | Box Qty | Price each |
|-----------|-------------|-------------|---------|------------|
| 51002 | 245mm | 580mm | - | €14.98D |



NEW

6 SB/1 Recovery Winch Safety Blanket

DRAPER Expert

Expert Quality, a safety must for all electric and hand operated winches. If the winch cable snaps the safety blanket absorbs the tension energy from the cable. Made from heavy duty vinyl with storage pockets for shackles and reflective area for nighttime visibility. Carton packed.

| Stock No. | Box Qty | Price each |
|-----------|---------|------------|
| 24445 | - | €33.69P |



BOX QUANTITY INFORMATION

FOR YOUR CONVENIENCE, WE RECOMMEND ORDERING IN BOX QUANTITY OR MULTIPLES OF BOX QUANTITY WHERE SHOWN. YOU CAN STILL ORDER IN ANY QUANTITY UNLESS SPECIFICALLY STATED OTHERWISE



1 EHC

Emergency Hammer/Cutter

For emergency use in the home, office, car and other travel. Shatters automotive and domestic glass. Cuts through automotive seat belts. Hardened carbon steel hammer striking point with tough ABS plastic contoured handle for user comfort. Supplied with mounting rack and fixings. Display packed.

| Stock No. | Length | Box Qty | Price each |
|-----------|--------|---------|------------|
| 61229 | 185mm | 10 | €12.03D |



2 WT1B

Vehicle Warning Triangle

To European Standard ECE R27 and tested to E1 Specifications

Folding design with stand and rubber feet. Manufactured from ABS plastic. Supplied in plastic carrying case. Display carton.

| Stock No. | Box Qty | Price each |
|-----------|---------|------------|
| 24342 | 6 | €13.60D |



9.5 and 25L AVAILABLE

3 PWB

Water Containers with Taps

Manufactured from high quality translucent virgin HDPE plastic. Suitable for storing and dispensing water. Supplied with integral 360° swiveling tap and easy flow screw vent. Sold loose.

| Stock No. | Capacity | Box Qty | Price each |
|-----------|----------|---------|------------|
| 23246 | 9.5L | 10 | €22.03D |
| 23247 | 25L | 4 | €27.83D |



4 PP12VB/HD1200

12V 1200A Heavy Duty Portable Power Pack

Versatile power pack ideal for petrol vehicles up to 3000cc and diesel vehicles up to 2200cc. LED charge indicators and 3W worklight. Heavy duty booster cables with insulated jaws. DC power socket allows the running of 12V/DC accessories. Rechargeable through a 230V AC supply or a 12V vehicle cigarette lighter socket. Display carton.

Specification:

| | |
|---------------------------|------------------------|
| Starting current | ... 600A |
| Peak current | ... 1200A |
| Max. engine starting size | ... 3000cc (petrol) |
| | ... 2200cc (diesel) |
| Battery | ... 22Ah (sealed lead) |
| Worklight | ... 3W |
| Weight | ... 6.5kg |

| Stock No. | Box Qty | Price each |
|-----------|---------|------------|
| 24341 | - | €162.33P |



5 PP12VB/HD

12V 900A Heavy Duty Portable Power Pack

Versatile power pack ideal for petrol vehicles up to 3000cc and diesel vehicles up to 2400cc. On/off power switch, voltmeter with battery charge, anti-surge protection and reverse polarity indicators. Heavy duty booster cables with insulated jaws. DC power socket allows the running of 12V/DC accessories to a maximum current of 15A. Rechargeable through a 230V AC supply or a 12V vehicle cigarette lighter socket. Display carton.

Specification:

| | |
|---------------------------|------------------------|
| Starting current | ... 400A |
| Peak current | ... 900A |
| Max. engine starting size | ... 3000cc (petrol) |
| | ... 2400cc (diesel) |
| Battery | ... 17Ah (sealed lead) |

| Stock No. | Box Qty | Price each |
|-----------|---------|------------|
| 40133 | - | €151.63P |



6 PP12VC/B

12V 700A Portable Power Pack with Air Compressor and Integral Light

Power pack ideal for petrol vehicles up to 2000cc and diesel vehicles up to 1800cc. On/off power switch, voltmeter with battery charge, anti-surge protection and reverse polarity indicators. Heavy duty booster cables with insulated jaws. DC power socket allows the running of 12V/DC accessories to a maximum current of 15A. Integral air compressor with pressure gauge, hose and popular adaptors. Rechargeable through a 230V AC supply or a 12V vehicle cigarette lighter socket. Display carton.

Specification:

| | |
|--------------------------|----------------------------|
| Starting current | ... 300A |
| Peak current | ... 900A |
| Battery | ... 12V 12Ah (sealed lead) |
| Light | ... 3.6W |
| Compressor (max out put) | ... 17.5 bar (260psi) |

| Stock No. | Box Qty | Price each |
|-----------|---------|------------|
| 40134 | - | €144.40P |

NEW



7 C2CB

12V DC Vehicle to Vehicle Booster

Easy to use car-to-car battery booster. Gives low vehicle batteries the boost required to get started with-in minutes. No need for jump leads just connect the booster between vehicles cigarette lighter sockets and minutes later the battery being charged will be ready for starting. Display packed.

Specification:

| | |
|----------------------|---------------------|
| Rated input | ... 12V DC |
| Rated output | ... 15V DC |
| Rated output current | ... 7A |
| Fuse rating | ... 15A |
| Connection leads | ... 1mm copper wire |
| Cable length | ... 6M (approx) |

| Stock No. | Box Qty | Price each |
|-----------|---------|------------|
| 46544 | - | €37.48P |

DAVE SAYS

Our Copper Coated Aluminium (CCA) booster cables utilise the latest technology for cost effective jump starting. Unlike other products in the market, our CCA cables are designed on an "Amp for Amp" basis to ensure they work correctly under load. Lower quality "gauge for gauge" cables offer a higher electrical resistance under load and can damage sensitive vehicle electronics as they are unable to deliver the load to the car when needed to start under difficult conditions.



1 JL25

DRAPER Expert

Heavy Duty Battery Booster Cables

Manufactured to BSAU 237a

Expert Quality, suitable for 12V and 24V cars and light commercial vehicles. Heavy duty full copper cable (25mm²) and fitted with heavy duty fully insulated clamps. Display packed in resealable PVC bag.

| Stock No. | Length | Box Qty | Price each |
|-----------|--------|---------|------------|
| 51875 | 3M | - | €99.95D |
| 54600 | 5M | - | €155.50D |



4 JL10

2M Battery Booster Cables

Suitable for 12V cars and light commercial vehicles. 10mm² full copper cable fitted with fully insulated clamps. Display packed.

| Stock No. | Box Qty | Price each |
|-----------|---------|------------|
| 51945 | - | €44.80D |



7 FTB3

Rigid Towing Brace

Manufactured to GS/TUV Specifications

Maximum rated load 2000kg. Length between hooks - 1800mm. Supplied in storage bag with ON TOW sign. Display carton.

| Stock No. | Box Qty | Price each |
|-----------|---------|------------|
| 88621 | - | €62.68D |



2 JL16

DRAPER Expert

3M Heavy Duty Battery Booster Cables

Manufactured to BSAU 237a

Expert Quality, suitable for 12V and 24V cars and light commercial vehicles. Heavy duty full copper cable (16mm²) and fitted with heavy duty fully insulated clamps. Display packed in resealable PVC bag.

| Stock No. | Box Qty | Price each |
|-----------|---------|------------|
| 51874 | - | €81.95D |



5

CCA Battery Booster Cables

High quality copper coated aluminium cables with fully insulated clamps, suitable for: 8mm² (up to 1.2L petrol vehicles); 10mm² (up to 1.5L petrol vehicles); 16mm² (up to 2.5L petrol/1.5L diesel vehicles); 25mm² (up to 5.5L petrol/3.0L diesel). Display packed in PVC zip up storage bag.

| Stock No. | Part No. | Length | Cable | Box Qty | Price each |
|-----------|----------|--------|-------------------|---------|------------|
| 06071 | ELJL8 | 1.8M | 8mm ² | - | €20.40D |
| 06072 | ELJL10 | 2.5M | 10mm ² | - | €27.98D |
| 06073 | ELJL16 | 3.0M | 16mm ² | - | €42.10D |
| 06001 | ELJL25 | 3.5M | 25mm ² | - | €68.85D |



8

3.7M Tow Ropes

Manufactured to BS AU 187

High visibility polypropylene with 'On Tow' sign and warning flag. Hooped one end and a zinc plated safety hook on the other. Display packed.

| Stock No. | Part No. | Colour | Capacity | Box Qty | Price each |
|-----------|----------|--------|----------|---------|------------|
| 63410 | TR2000 | Yellow | 2000kg | - | €13.83D |
| 65297 | TR4000 | Red | 4000kg | - | €28.38D |



3 JLSP

5M Anti-Surge Protected Heavy Duty Battery Booster Cables

Suitable for 12V and 24V cars and light commercial vehicles. Heavy duty copper coated cable (25mm²) fitted with inline anti surge protection and heavy duty insulated clamps. Display packed in a zip storage bag.

| Stock No. | Box Qty | Price each |
|-----------|---------|------------|
| 23264 | - | €75.05D |

SEE PRODUCT VIDEO
www.drapertools.com/drapertv



6 ELMCJL

2M Motorcycle Battery Booster Cables

Suitable for 12V motor cycles. Full copper cable 3.6mm². Fitted with fully insulated compact clips. Display packed in resealable PVC bag.

| Stock No. | Box Qty | Price each |
|-----------|---------|------------|
| 06074 | - | €20.40D |



9 TR2500A

4.27M Concertina Tow Rope

Manufactured in accordance with BSAU 187

Sixteen strand polyethylene with safety hooks and lock which are zinc plated forged S45C carbon steel. Display packed.

| Stock No. | Box Qty | Price each |
|-----------|---------|------------|
| 67256 | 6 | €22.63D |



DAVE SAYS

Not all fuel cans are the same and it's what you can't see that can make a BIG difference. All Draper steel fuel cans are manufactured from 0.9mm thick high quality steel (as required by the DIN 7274 standard). The can is powder coated for rust protection, with the inside being treated with a specially formulated petrol resistant alkyd-ammonia coating and the seam is robot welded for maximum strength and no leaks. To enable fast "glug-free" emptying - the can is engineered with a special wide-channel breather system, enabling you to empty a full 20 litre can in just 25 seconds - especially useful if being used at the roadside for minimal exposure to danger.

An internationally patented cap locking system ensures no leaks - no matter what position the can is in and each 20 litre can carries the UN certificate number to comply with the Dangerous Goods Transportation Regulations."

FEATURE PACKED FUEL CANS

- 1 Powder coated body
- 2 Holes for spout clip
- 3 Petrol resistant internal coating
- 4 Wide breathing channel
- 5 0.9mm steel
- 6 Date stamp on the cap
- 7 Patented locking pin
- 8 Bayonet closure
- 9 UN number
- 10 Strip welded handles

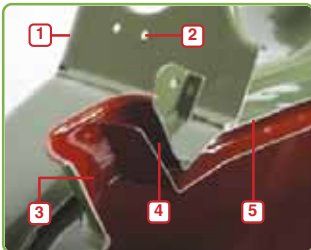

GREEN FUEL SPOUT AVAILABLE
STOCK No. 49946



BLACK FUEL SPOUT AVAILABLE
STOCK No. 49945



RED FUEL SPOUT AVAILABLE
STOCK No. 49947

1 Green Steel Fuel Cans

Manufactured from 0.9mm sheet steel, this robust green painted fuel can is available in three capacities and will store flammable liquids (only). Patented cap locking system keeps the contents secure and the bayonet cap closure device ensures can is leakproof in any position. Wide channel breather for smooth and steady pouring. Sold loose.

| Stock No. | Description | Box Qty | Price each |
|-----------|-----------------------|---------|------------|
| 49957 | 5L Fuel Can | 5 | €44.60D |
| 49952 | 10L Fuel Can | 5 | €56.18D |
| 49949 | 20L Fuel Can | 4 | €63.83D |
| 49946 | Green Spout + Bracket | - | €20.75D |

2 Black Steel Fuel Cans

Manufactured from 0.9mm sheet steel, this robust black painted fuel can is available in three capacities and will store flammable liquids (only). Patented cap locking system keeps the contents secure and the bayonet cap closure device ensures can is leakproof in any position. Wide channel breather for smooth and steady pouring. Sold loose.

| Stock No. | Description | Box Qty | Price each |
|-----------|-----------------------|---------|------------|
| 49956 | 5L Fuel Can | 5 | €44.60D |
| 49954 | 10L Fuel Can | 5 | €56.18D |
| 49948 | 20L Fuel Can | 4 | €63.83D |
| 49945 | Black Spout + Bracket | - | €20.75D |

3 Red Steel Fuel Cans

Manufactured from 0.9mm sheet steel, this robust red painted fuel can is available in three capacities and will store flammable liquids (only). Patented cap locking system keeps the contents secure and the bayonet cap closure device ensures can is leakproof in any position. Wide channel breather for smooth and steady pouring. Sold loose.

| Stock No. | Description | Box Qty | Price each |
|-----------|---------------------|---------|------------|
| 49955 | 5L Fuel Can | 5 | €44.60D |
| 49953 | 10L Fuel Can | 5 | €56.18D |
| 49951 | 20L Fuel Can | 4 | €63.83D |
| 49947 | Red Spout + Bracket | - | €20.75D |



4 PFC-GREEN 5L Green Plastic Fuel Can

Manufactured and tested in accordance with SI1982/630 Regulations
High quality HDPE plastic with screw-on rigid plastic pouring hose and deep gasket sealed and tethered plastic screwcap. Sold loose.

| Stock No. | Description | Box Qty | Price each |
|-----------|-------------|---------|------------|
| 48358 | Fuel Can | 10 | €14.10D |
| 31084 | Spare Spout | - | €4.98D |



5 PFC-BLACK 5L Black Plastic Fuel Can

Manufactured and tested in accordance with SI1982/630 Regulations
High quality HDPE plastic with screw-on rigid plastic pouring hose and deep gasket sealed and tethered plastic screw cap. Sold loose.

| Stock No. | Description | Box Qty | Price each |
|-----------|-------------|---------|------------|
| 23229 | Fuel Can | 12 | €14.10D |
| 31084 | Spare Spout | - | €4.98D |



6 PFC-RED 5L Red Plastic Fuel Can

Manufactured and tested in accordance with SI1982/630 Regulations
High quality HDPE plastic with screw-on rigid plastic pouring hose and deep gasket sealed and tethered plastic screw cap. Sold loose.

| Stock No. | Description | Box Qty | Price each |
|-----------|-------------|---------|------------|
| 23227 | Fuel Can | 12 | €14.10D |
| 31084 | Spare Spout | - | €4.98D |



PROFESSIONAL AUTOMOTIVE WORKSHOP ADHESIVES

To assist in identifying the right adhesive, we've created easy to classify symbols.

These are in the form of a circle and a droplet. The circle represents a thicker more viscous product while the droplet indicates that it has a thinner viscosity.



1 DMVB/CAMV
Super Glue

Medium viscosity cyanoacrylate adhesive designed for quick strong bonding of metals, plastic, wood, ceramics, rubber, leather, card, glass etc. Requires a clean surface on which to bond. Display packed.

| Stock No. | Pack Size | Box Qty | Price each |
|-----------|-----------|---------|------------|
| 24669 | 20g | 20 | €8.35D |



2 DTL222
D222 Thread Lock

Ideal for low-strength thread locking on adjusting screws, countersunk head screws and set screws. Very good on low strength metals which could break during disassembly. Low strength break away - 6Nm. Display packed.

| Stock No. | Pack Size | Box Qty | Price each |
|-----------|-----------|---------|------------|
| 24657 | 50ml | 20 | €18.08D |



3 DNL243
D243 Nut Lock

Medium strength (16Nm break away) oil tolerant design for direct application onto parts where a light oily film exists or where surrounding parts contamination is a problem. Display packed.

| Stock No. | Pack Size | Box Qty | Price each |
|-----------|-----------|---------|------------|
| 24660 | 50ml | 20 | €18.08D |



4 DSL270
D270 Stud Lock

High strength (40Nm break away) general purpose adhesive for permanent threaded assemblies. Secures studs up to 13mm, sealing against leakage and corrosion. Chemical resistant while also resisting fuels, lubricants and most industrial liquids and gases. Display packed.

| Stock No. | Pack Size | Box Qty | Price each |
|-----------|-----------|---------|------------|
| 24659 | 50ml | 20 | €18.08D |



5 DBF641
D641 Bearing Fit

Single part anaerobic securing compound, designed for fitting cylindrical metal assemblies and cures when confined between the parts. Will secure all types and sizes of bearings, shafts and cylindrical parts. Display packed.

| Stock No. | Pack Size | Box Qty | Price each |
|-----------|-----------|---------|------------|
| 24662 | 50ml | 20 | €19.48D |



6 DBSR638
D638 Bush and Sleeve Retainer

Designed to give high strength retention under cyclic loading. Retains full strength and won't suffer fatigue under load stress. Suited for structural components such as cylindrical parts under load, keys, splines, and structural tubing. Display packed.

| Stock No. | Pack Size | Box Qty | Price each |
|-----------|-----------|---------|------------|
| 24667 | 50ml | 20 | €19.48D |



7 DBAS572
D572 Brake and Air Line Seal

Designed for sealing metal pipes and fittings. Product cures due to the absence of air between close fitting metal surfaces. Prevents loosening and leakage from shock and vibration. Good chemical/solvent resistance to ethanol, motor oil, unleaded petrol and brake fluid. Unique adhesion allows for re-alignment up to 60 hours after application. Display packed.

| Stock No. | Pack Size | Box Qty | Price each |
|-----------|-----------|---------|------------|
| 24665 | 50ml | 20 | €13.90D |



8 DMG574
D574 Multi Gasket

Instant gasket material which forms in place, making almost any size and shape, replacing paper, cork etc. Once applied the assembled parts are usually suitable for immediate low pressure (6 bar) service and once cured can resist 350 bar pressure depending on gap size. Display packed.

| Stock No. | Pack Size | Box Qty | Price each |
|-----------|-----------|---------|------------|
| 24661 | 50ml | 20 | €13.90D |



9 DPW3294
D3294 Plastic Weld

A toughened structural adhesive formulated for bonding differing substrates as well as unprepared metals, ceramics, wood, concrete and standard thermoset plastics. The final adhesive bond is designed to be load bearing and resistant to weathering, humidity and temperature variations. Display packed.

| Stock No. | Pack Size | Box Qty | Price each |
|-----------|-----------|---------|------------|
| 24668 | 28ml | 20 | €12.50D |

SEE PRODUCT VIDEO
www.drapertools.com/drapertv



1 DEPR2012

D2012 Epoxy Structural Adhesive

Two part, cold curing epoxy resin adhesive. Suitable for bonding a wide range of surfaces including steel, aluminium, and galvanised iron. Reacts within five minutes to give a tough resilient bond. Display packed.

| Stock No. | Pack Size | Box Qty | Price each |
|-----------|-----------|---------|------------|
| 24663 | 28ml | 20 | €11.13D |

NEW



2 DFG515

D515 Flexible Gasket

Easily applied flexible gasket paste, which forms a tough purple temperature resistant gasket. Its high viscosity and fast curing enables the paste to seal almost any size and shape creating an instant low pressure seal while removing the need for traditional paper or cork gaskets. Display packed.

| Stock No. | Pack Size | Box Qty | Price each |
|-----------|-----------|---------|------------|
| 31908 | 50ml | 20 | €13.10D |

NEW



3 DIFG518

D518 Flexible Gasket

Easily applied flexible gasket paste ideal for aluminium flanges forming a tough red, temperature resistant gasket. Its high viscosity and fast curing enables the paste to seal almost any size and shape creating an instant low pressure seal while removing the need for traditional paper or cork gaskets. Display packed.

| Stock No. | Pack Size | Box Qty | Price each |
|-----------|-----------|---------|------------|
| 31909 | 50ml | 20 | €13.10D |

NEW



4 DHS542

D542 Hydraulic Seal

D542 for metal threaded fittings especially useful on hydraulic pipes. Used on low, medium and high-pressure lines and cures to form a tough high-pressure seal. Ideal for valves, threaded couplings and adaptors. Display packed.

| Stock No. | Pack Size | Box Qty | Price each |
|-----------|-----------|---------|------------|
| 33321 | 50ml | 20 | €18.90D |

NEW



5 DLPTFE

50ml Liquid PTFE

Provides instant seals and cures rapidly. When fully cured it's capable of sealing metal threaded joints up to 350 bar. Perfect for use on metal threads within cold - hot water, gas and compressed air systems. Display packed

| Stock No. | Pack Size | Box Qty | Price each |
|-----------|-----------|---------|------------|
| 38916 | | 20 | €16.23D |

NEW



6 DFTRP

Fuel Tank Repair Putty

Specialist epoxy putty, ideal for patching holes in fuel tanks, radiators, pipes etc. When mixing, the putty turns a unified colour signifying it's ready for use. Hardens and cures in extreme conditions. Bonds to metal, fibreglass, wood, concrete and glass. Display packed.

| Stock No. | Pack Size | Box Qty | Price each |
|-----------|-----------|---------|------------|
| 31033 | | 20 | €10.63D |

AUTOMOTIVE ASSORTMENTS

Shown below and opposite is a useful range of O-rings, Fuses, Springs and other assortments for general automotive use. Remember, all Draper products are fully guaranteed.



7 O-RING/419

419 piece O-Ring Assortment

An assortment O-rings, size range 3mm I.D. x 1.5mm section to 50mm I.D. x 3.5mm section. Packed in blow mould storage case with display sleeve.

| Stock No. | Box Qty | Price p/assrt |
|-----------|---------|---------------|
| 56345 | 4 | €47.85D |



8 O-RING/225

225 piece O-Ring Assortment

Assortment of O-rings in plastic storage case. Display carton.

| Stock No. | Box Qty | Price p/assrt |
|-----------|---------|---------------|
| 56377 | 10 | €19.58D |



9 NPFS272

272 piece Number Plate Fixing Kit

Complete number plate fixings kit. Supplied with black, yellow and white screw covers, self tapping screws, yellow nylon bolts, black nylon nuts and double sided sticky pads. Supplied in storage case. Display packed.

| Stock No. | Box Qty | Price per kit |
|-----------|---------|---------------|
| 26344 | - | €27.28D |

CONSUMABLES AND ACCESSORIES



1 FUSE/MINI 100

100 piece Mini Automotive Plug-In Fuse Assortment

Assortment of mini automotive fuses in plastic storage case. Assortment includes fuses of ratings: 3A, 5A, 7.5A, 10A, 15A, 20A, 25A and 30A. Display carton.

| Stock No. | Box Qty | Price p/assrt |
|-----------|---------|---------------|
| 24311 | | €17.73D |



2 FUSE/120

120 piece Standard Automotive Plug-In Fuse Assortment

Assortment of standard automotive fuses in plastic storage case. 20 each of (approx.) fuses of ratings: 5A, 10A, 15A, 20A, 25A and 30A. Display carton.

| Stock No. | Box Qty | Price p/assrt |
|-----------|---------|---------------|
| 56381 | — | €21.15D |



3 FUSE/MAXI 24

24 piece Maxi Automotive Plug-In Fuse Assortment

Assortment of maxi automotive fuses in plastic storage case. Assortment includes fuses of ratings: 20A, 30A, 40A, 50A, 60A, 70A, 80A and 100A. Display carton.

| Stock No. | Box Qty | Price p/assrt |
|-----------|---------|---------------|
| 24313 | — | €30.00D |



4 AEL338

338 piece Automotive Electrical Assortment

Assortment of essential electrical parts used in a variety of different automotive applications. The assortment includes blue and yellow terminals, blue and yellow butt connectors, blue male and female blade connectors, cable ties, cable clamp and heat shrink tubing. Display packed in plastic storage box.

| Stock No. | Box Qty | Price p/assrt |
|-----------|---------|---------------|
| 24314 | — | €27.28D |



5 HST95

95 piece Heat Shrink Tube Assortment

An assortment of 95 (approx.) heat shrink tubes for sealing automotive electrical connections. To be used in conjunction with hot air guns. Supplied in plastic organiser with see-through lid. Display packed.

| Stock No. | Box Qty | Price p/assrt |
|-----------|---------|---------------|
| 72878 | 6 | €15.95D |



6 SPRING/200

200 piece Compression and Extension Spring Assortment

Assortment of plated compression and extension springs in plastic storage case. Display packed.

| Stock No. | Box Qty | Price p/assrt |
|-----------|---------|---------------|
| 56380 | 10 | €20.60D |



7 ROLL/120

120 piece Roll Pin Assortment

Popular imperial sized roll pins in plastic storage case. Display carton.

| Stock No. | Box Qty | Price p/assrt |
|-----------|---------|---------------|
| 63943 | 10 | €14.48D |



8 COTTER/555

555 piece Split Pin Assortment

Assortment of zinc plated split pins in plastic storage case. Display carton.

| Stock No. | Box Qty | Price p/assrt |
|-----------|---------|---------------|
| 56375 | 10 | €20.98D |



9 HAIRP/150

150 piece R-Clip Assortment

Assortment of R-clips in plastic storage case. Display packed.

| Stock No. | Box Qty | Price p/assrt |
|-----------|---------|---------------|
| 56376 | 10 | €27.85D |



10 CIRCLIP/285

285 piece Internal and External Circlip Assortment

Assortment of internal and external circlips in plastic storage case. Display carton.

| Stock No. | Box Qty | Price p/assrt |
|-----------|---------|---------------|
| 56379 | 10 | €29.80D |



11 WASHER/720

720 piece Spring and Star Washer Assortment

Assortment of spring, internal and external star washers in plastic storage case. Display carton.

| Stock No. | Box Qty | Price p/assrt |
|-----------|---------|---------------|
| 56378 | 10 | €20.70D |



12 E-CLIP/300

300 piece E-Clip Assortment

Assortment of 300 (approx.) popular metric sized E-Clips in plastic storage case. Display carton.

| Stock No. | Box Qty | Price p/assrt |
|-----------|---------|---------------|
| 63941 | 10 | €24.53D |



1 MR-DS

400ml Mr D's Moisture Dispersant

Dual purpose moisture and penetrating oil, suitable for dispersing moisture from electrical systems and as a general lubricating and penetrating oil. Sold loose.

Available in singles - order multiples of 12 to get a free countertop display

| Stock No. | Box Qty | Price each |
|-----------|---------|------------|
| 41921 | 12 | €7.65D |



2 ARE-BCL/A

400ml Brake and Clutch Cleaner

Ideal for cleaning all parts of modern brake and clutch systems. Eliminates brake squeal and clutch slip caused by contamination and glazing. CFC free. Sold loose.

Available in singles - order multiples of 12 to get a free countertop display

| Stock No. | Box Qty | Price each |
|-----------|---------|------------|
| 41925 | 12 | €7.63D |



3 ARE-DBR/A

400ml Dashboard Renovator

Fast shining blend of cleaning solvents and silicones. Suitable for restoring internal trims and dashboards, cleans and polishes vinyl, leather and wood back to a sparkling appearance. It also is an effective oil and stain remover and can be used as a non-staining lubricant on windows, doors, hinges and locks. CFC free. Sold loose.

Available in singles - order multiples of 12 to get a free countertop display

| Stock No. | Box Qty | Price each |
|-----------|---------|------------|
| 41919 | 12 | €7.70D |



4 ARE-CCL/A

400ml Carburettor and Injector Cleaner

Ideal for cleaning carburettors, injectors and brake parts. Helps prevent stalling and rough idling. CFC free. Sold loose.

Available in singles - order multiples of 12 to get a free countertop display

| Stock No. | Box Qty | Price each |
|-----------|---------|------------|
| 41922 | 12 | €7.58D |



5 ACC-DEG

400ml Degreaser

Ideal for use in vehicle engines to remove grease and dirt from metal surfaces. CFC free. Sold loose.

Available in singles - order multiples of 12 to get a free countertop display

| Stock No. | Box Qty | Price each |
|-----------|---------|------------|
| 76108 | 12 | €9.03D |



6 ARE-LEAK

400ml Leak Detector

For detecting leaks in gas piping, refrigerator coolant pipes, vehicle air conditioning units, workshop air lines etc. Any leaks and their severity are betrayed by bubbles within the surface tension of the fluid. CFC free. Sold loose.

Available in singles - order multiples of 12 to get a free countertop display

| Stock No. | Box Qty | Price each |
|-----------|---------|------------|
| 76110 | 12 | €7.25D |

7 ARE-ACC

150ml Vehicle Air Conditioning Cleaner

A quick and easy way to clean and refresh vehicle air conditioning systems in minutes. Kills bacteria present in the air conditioning unit. Aerosol can is placed in footwell of vehicle, air conditioning is turned on 'internal circulation' and can locked on and completely discharged whilst air conditioning is working. CFC free. Sold loose.

| Stock No. | Box Qty | Price each |
|-----------|---------|------------|
| 76107 | 12 | €13.30D |

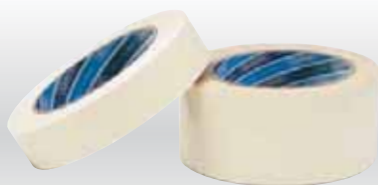

8 TP-MASKPRO

50M Professional Masking Tape

Expert Quality, low tack, easy tear and re-positional. Ideal for professional usage. Can be used for low bake masking applications. Clean peel up to 12 hours after usage. Display packed.

| Stock No. | Width | Box Qty | Price per roll |
|-----------|-------|---------|----------------|
| 63478 | 25mm | - | €4.23D |
| 63479 | 50mm | - | €7.35D |

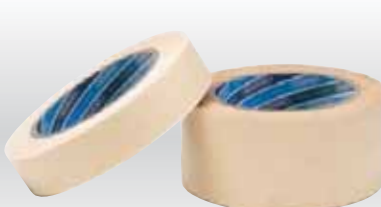

9 TP-MASK

50M Masking Tape

Easy tear and re-positional. Ideal for decorating, drilling or spraying. Clean peel up to 3 hours after usage. Display packed.

| Stock No. | Width | Box Qty | Price per roll |
|-----------|-------|---------|----------------|
| 63481 | 25mm | - | €3.80D |
| 63480 | 50mm | - | €6.70D |

MORE CONSUMABLES FOR THE WORKSHOP

See pages 644-647 for a collection of hazard tape rolls, duct tape rolls and banner tape which can be used around the workshop. Additional aerosols are also available including spray adhesive, graffiti remover and line marker paint.



TELESCOPIC BRUSHES



1 WWB1

Flow Through Telescopic Washing Brush

For cleaning vehicles, boats, paintwork, conservatories etc. Has on/off water control feature and snap-on hose connector. Display packed.

| Stock No. | Min. Length | Max. Length | Box Qty | Price each |
|-----------|-------------|-------------|---------|------------|
| 74190 | 1200mm | 1800mm | - | €44.90D |

2 TSB

Soft Grip Telescopic Brush and Scraper

For removing snow, ice and leaves from cars, vans, conservatories etc. Head rotates 90° for easier access to car roofs. Detachable ice scraper and brush/squeegee. Locking extendable handle. Hanging display card.

| Stock No. | Min. Length | Max. Length | Box Qty | Price each |
|-----------|-------------|-------------|---------|------------|
| 12094 | 950mm | 1280mm | 6 | €42.13D |

3 WB2

Telescopic Squeegee and Sponge

200mm neoprene rubber blade on one side and foam sponge on other. Twist and lock handle. Hanging display card.

| Stock No. | Min. Length | Max. Length | Box Qty | Price each |
|-----------|-------------|-------------|---------|------------|
| 73860 | 460mm | 725mm | - | €9.50D |

VEHICLE CLEANING PRODUCTS

More products ideal for cleaning vehicles are shown on pages 652-656.



DAVE SAYS

QUALITY MAKES THE DIFFERENCE

DAVE SAYS

TELESCOPIC BRUSHES

All our telescopic brushes reduce to a handy carrying size for easy portability to the work location. The opening mechanisms are simple for years of trouble-free operation. Each of the three types of brushes have specific uses - Item No. 1 for general working, Item No. 2 for snow and ice clearance and Item No. 3 for window washing.



4 WB-DG

300mm Silicone Squeegee

For wiping surplus liquids from scratch resistant surfaces such as windows etc. Silicone rubber blade and soft grip handle. Display packed.

| Stock No. | Box Qty | Price each |
|-----------|---------|------------|
| 76482 | 12 | €9.48D |



5 WB

300mm Squeegee

For wiping surplus liquids from scratch resistant surfaces such as windows etc. Neoprene rubber blade and additional serrated edge. Display packed.

| Stock No. | Box Qty | Price each |
|-----------|---------|------------|
| 69207 | 12 | €6.30D |

NEW



6 ISM

Ice Scraper and Mitt

Ice scraper with integrated mitt, keeps hand warm and dry when scraping ice or snow from car windows. Display packed.

| Stock No. | Box Qty | Price each |
|-----------|---------|------------|
| 33011 | 12 | €6.23D |

NEW



7 IWS

Ice and Window Scraper

Plastic 100mm wide ice and window scraper with foam soft grip handle and rubber window scraper blade. Display packed

| Stock No. | Box Qty | Price each |
|-----------|---------|------------|
| 33009 | 6 | €3.13D |

BOX QUANTITY INFORMATION

FOR YOUR CONVENIENCE, WE RECOMMEND ORDERING IN BOX QUANTITY OR MULTIPLES OF BOX QUANTITY WHERE SHOWN. YOU CAN STILL ORDER IN ANY QUANTITY UNLESS SPECIFICALLY STATED OTHERWISE



PAUL SAYS

Our Tie Down Straps show the S.W.L (safe working load) which is the load the straps can safely take. The breaking strain (or proof load) is that which will break the strap

QUALITY ASSURANCE MAKES THE DIFFERENCE

and must not be exceeded. Therefore to gauge usage always use the S.W.L.



1

50mm wide Heavy Duty Ratchet Tie Down Straps with D Rings

Quality polyester webbing with D rings. S.W.L.2500kg (breaking strain 5000kg) per strap. Display carton.

| Stock Part No. | Length | Box Qty | Price each |
|--------------------|--------|---------|------------|
| 49485 RTDS/5M5T/D | 5M | - | €30.85D |
| 49486 RTDS/8M5T/D | 8M | - | €37.48D |
| 49487 RTDS/10M5T/D | 10M | - | €42.18D |

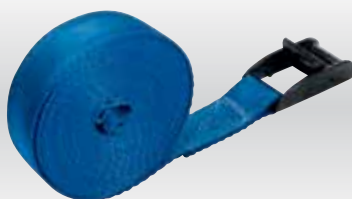

4

TDS/A 4M x 25mm Tie Down Strap

Quality webbing with cam locking buckle. S.W.L. 60kg (proof load 120kg) per strap. Display carton.

| Stock No. | Box Qty | Price each |
|-----------|---------|------------|
| 64215 | 6 | €5.88D |



2

50mm wide Heavy Duty Ratchet Tie Down Straps with Hooks

Quality polyester webbing with hooks. S.W.L.2500kg (breaking strain 5000kg) per strap. Display carton.

| Stock Part No. | Length | Box Qty | Price each |
|--------------------|--------|---------|------------|
| 49488 RTDS/5M5T/H | 5M | - | €33.25D |
| 49489 RTDS/8M5T/H | 8M | - | €40.40D |
| 49490 RTDS/10M5T/H | 10M | - | €44.90D |



5

RTDS Ratchet Tie Down Straps

Quality webbing with two hooks. Proof load Stock Nos. 64216-750kg; 64217-1000kg; 64218-4000kg. Display carton.

| Stock No. | Length | Width | S.W.L. | Box Qty | Price each |
|-----------|--------|-------|--------|---------|------------|
| 64216 | 4.5M | 25mm | 375kg | 4 | €12.30D |
| 64217 | 5.4M | 50mm | 500kg | 2 | €41.33D |
| 64218 | 8.0M | 50mm | 2000kg | - | €57.25D |



3

RTDS25A4 Pack of Four 4.5M x 25mm Tie Down Straps

Quality polyester webbing with cam locking buckle. S.W.L. 375kg (breaking strain 750kg) per strap. Display carton.

| Stock No. | Box Qty | Price p/pack |
|-----------|---------|--------------|
| 45279 | - | €39.58D |



6

RTDS25B2 Pack of Two 3.5M x 25mm Ratchet Tie Down Straps

Quality polyester webbing with ratcheting locking buckle. S.W.L. 250kg (breaking strain 500kg) per strap. Supplied with convenient hanger for safe keeping. Display carton.

| Stock No. | Box Qty | Price p/pack |
|-----------|---------|--------------|
| 24889 | - | €17.83D |



7

RTDS25B4 Pack of Four 5M x 25mm Ratchet Tie Down Straps

Quality polyester webbing with ratcheting locking buckle. S.W.L. 250kg (breaking strain 500kg) per strap. Supplied with convenient hanger for safe keeping. Display carton.

| Stock No. | Box Qty | Price p/pack |
|-----------|---------|--------------|
| 24890 | - | €34.05D |

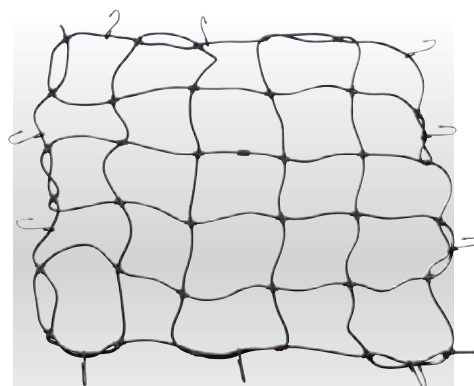

8

BCNET Elastic Cargo Net

Elasticated rubber with 12 steel hooks. For keeping loads safe in transit. Overall size 750 x 750mm. Display packed.



| Stock No. | Box Qty | Price each |
|-----------|---------|------------|
| 89202 | - | €15.95D |

CONSUMABLES AND ACCESSORIES



1 BCHD80
800mm Heavy Duty Elastic Straps

Manufactured to GS/TUV and BSAU 258 **Expert Quality**, powerful elastic straps manufactured from virgin rubber with extra strength hooks for holding awkward loads. Lashing capacity 40kg. Display packed two straps per pack.

| Stock No. | Box Qty | Price p/pair |
|-----------|---------|--------------|
| 89200 | - | €8.25D |



2 BCLD80
800mm Elastic Straps

Manufactured to GS/TUV and BSAU 258 Powerful elastic straps manufactured from virgin rubber with double folded steel hooks. Lashing capacity 20kg. Display packed two straps per pack.

| Stock No. | Box Qty | Price p/pair |
|-----------|---------|--------------|
| 89199 | - | €7.85D |



ADJUSTABLE LENGTH



3 BCADJ1000
200-1000mm Adjustable Length Elastic Straps

Manufactured to GS/TUV and BSAU 258 Powerful elastic straps manufactured from virgin rubber with adjustable length locking hooks. Lashing capacity 27kg. Display packed two straps per pack.

| Stock No. | Box Qty | Price p/pair |
|-----------|---------|--------------|
| 89201 | - | €9.30D |

NEW



4 DAB10/B
10 Assorted Elastic Straps

GS Approved
Powerful elastic straps manufactured from virgin rubber with steel hooks. Display packed in plastic tube with screw-on lid. Contents:

- 4 straps length 250mm (approx.) unstretched
- 2 straps length 600mm (approx.) unstretched
- 2 straps length 800mm (approx.) unstretched
- 2 straps length 1000mm (approx.) unstretched

Available in singles - order multiples of nine to get a free countertop dispenser

| Stock No. | Box Qty | Price p/assrt |
|-----------|---------|---------------|
| 46447 | 9 | €13.85D |



NEW

5 AB20/B
20 Assorted Elastic Straps

Powerful elastic straps manufactured from virgin rubber with steel hooks. Display packed in plastic tube with screw-on lid. Contents:

- 4 straps length 250mm (approx.) unstretched
- 4 straps length 450mm (approx.) unstretched
- 4 straps length 500mm (approx.) unstretched
- 4 straps length 600mm (approx.) unstretched
- 4 straps length 750mm (approx.) unstretched

| Stock No. | Box Qty | Price p/assrt |
|-----------|---------|---------------|
| 36706 | - | €20.85D |



REVOLUTIONARY NON-SLIP DRAPER GRIPMAT®

GRIPMAT®

USES LIMITED ONLY BY ONE'S IMAGINATION!

6
Rolls of Non-Slip Draper GRIPMAT®

Revolutionary multi-purpose non-slip mat that will grip and protect almost any surface. Draper GRIPMAT® will not shift or move on most surfaces. Manufactured from flame-retardant, mould, mildew and mothproof material with 10 year non-slip guarantee. Easy to clean, just rinse with water and lay flat to dry. Shrink wrapped for security. Display packed.



| Stock No. | Part No. | Approx. Size | Box Qty | Price per roll |
|-----------|----------|--------------|---------|----------------|
| 54672 | DGM1 | 300 x 1820mm | - | €21.05D |
| 54673 | DGM2 | 450 x 1820mm | - | €30.08D |



7 DGM6
450 x 665mm Heavy Duty Non-Slip Draper GRIPMAT® Plus

Revolutionary multi-purpose heavy duty non-slip cushioning mat that will grip and protect almost any surface. Draper GRIPMAT® Plus will not shift or move on most surfaces. Manufactured from flame-retardant, mould, mildew and mothproof material with 10 year non-slip guarantee. Easy to clean, just rinse with water and lay flat to dry. Shrink wrapped in roll for security. Display packed.

| Stock No. | Box Qty | Price each |
|-----------|---------|------------|
| 56461 | - | €36.30D |

BOX QUANTITY INFORMATION

FOR YOUR CONVENIENCE, WE RECOMMEND ORDERING IN BOX QUANTITY OR MULTIPLES OF BOX QUANTITY WHERE SHOWN. YOU CAN STILL ORDER IN ANY QUANTITY UNLESS SPECIFICALLY STATED OTHERWISE

DAVE SAYS

INVERTERS IN VEHICLES

All vehicle electrics are DC - direct current - and are therefore unable to power household or industrial AC - alternating current items. The answer to this problem is the inverter. It does what it says; it inverts DC current to AC current thereby allowing the use of 230VAC products in the vehicle.

Which inverter to use? The Draper inverters are all 12V. There are three wattages - 200W, 400W and 1000W; your choice will depend on what appliances you wish to run - high drain includes kettles, heaters, televisions, laptops - so a 1000W would seem the most likely candidate, whereas if it is lighting or a smartphone etc. then the smaller 200W is ideal.



INCLUDES USB PORT



1 IN150 150W DC-AC Inverter

Cylindrical design enables converter to fit into the drinks holder in vehicles. Converts 12V DC to 230V AC. Uses power via car cigarette lighter plug fitting. Ideal for use in caravans, boats, HGVs etc. for use with appliances that require mains power and have 3 pin UK-type plugs. Fitted with a USB port for charging mobile phones and MP3 players etc. Has on/off switch. Display packed.

Specification:

| | |
|----------------|---------------------------|
| Input voltage | ... 12V DC |
| Output wattage | ... 150W continuous power |
| Max wattage | ... 300W (peak power) |
| Output voltage | ... 230V AC |
| Wave form | ... modified sine |

| Stock No. | Box Qty | Price each |
|-----------|---------|------------|
| 23244 | - | €54.55P |

NEW



3 IN400/USB 12V 400W DC-AC Inverter

Takes 12V DC from a vehicle's battery and converts it to 230V AC. Used with appliances that have 3 pin UK-type plugs. Fitted with a USB port for charging mobile devices this makes the chargers flexibility ideal for use in caravans, boats, HGVs etc. For safeguarding appliances, the unit is fitted with an overload alarm and reverse polarity protection. Display packed.

Specification:

| | |
|----------------|---------------------------|
| Input voltage | ... 12V DC |
| Output wattage | ... 400W continuous power |
| Max wattage | ... 800W (peak power) |
| Output voltage | ... 230V AC |
| Wave form | ... modified sine |

| Stock No. | Box Qty | Price each |
|-----------|---------|------------|
| 28815 | - | €74.98P |



5 AA2 12V DC 3 Way Extension Lead With USB Port

In-car 12V plug with three sockets and USB port. Maximum load 8A. Supplied with 2M lead. Display packed.

| Stock No. | Box Qty | Price each |
|-----------|---------|------------|
| 12076 | - | €14.78D |

NEW



2 IN200/USB 12V 200W DC-AC Inverter

Takes 12V DC from a vehicle's battery and converts it to 230V AC. Used with appliances that have 3 pin UK-type plugs. Fitted with a USB port for charging mobile devices this makes the chargers flexibility ideal for use in caravans, boats, HGVs etc. For safeguarding appliances, the unit is fitted with an overload alarm and reverse polarity protection. Display packed.

Specification:

| | |
|----------------|---------------------------|
| Input voltage | ... 12V DC |
| Output wattage | ... 200W continuous power |
| Max wattage | ... 400W (peak power) |
| Output voltage | ... 230V AC |
| Wave form | ... modified sine |

| Stock No. | Box Qty | Price each |
|-----------|---------|------------|
| 28814 | - | €53.75P |



4 IN1000 12V 1000W DC-AC Inverter

Converts 12V DC to 230V AC and has reverse polarity protection. Designed to be hard wired into 12V supply. Fitted with a USB port for charging mobile phones and MP3 players etc. 1000W continuous power (2000W peak power) ideal for use in caravans, boats, HGVs etc. for appliances that use mains voltage. Has two standard three pin plug sockets, on/off switch with LED power indicator, cooling fan and overload shutdown/alarm. Base fixing facility for permanent use. Display packed.

Specification:

| | |
|----------------|----------------------------|
| Input voltage | ... 12V DC |
| Output wattage | ... 1000W continuous power |
| Max wattage | ... 2000W (peak power) |
| Output voltage | ... 230V AC |
| Wave form | ... modified sine wave |

| Stock No. | Box Qty | Price each |
|-----------|---------|------------|
| 23245 | - | €177.30P |



AUTOMOTIVE LIGHTING

See Section 13, pages 633-634, for a range of inspection lamps.





1

Mechanics Foam Mats

Ideal for working under vehicles etc. High quality closed-cell EVA foam fully oil and water-resistant. Packed in polythene bag with label.

| Stock No. | Part No. | Size | Box Qty | Price each |
|-----------|----------|-------------|---------|------------|
| 64278 | MM1 | 220 x 336mm | - | €19.30D |
| 64279 | MM2 | 980 x 380mm | - | €55.20D |



CREEPER/SEATS

2 CC2

Mechanics Creeper/Seat

Creeper that easily converts to seat form. Heavy duty powder coated steel frame with adjustable head rest. Padded PVC covered seat and head rest. Seven swivel action castors for easy movement around the workshop. Converts to seat by pulling lifting strap. Display carton.

| Stock No. | Overall Length | Box Qty | Price each |
|-----------|----------------|---------|------------|
| 56224 | 1200mm | - | €135.53P |



2



3 CC4

Mechanics Creeper

Rigid PVC construction with six multi directional castors for easy movement. Moulded back for user comfort with tool trays and foam head rest. Maximum carrying weight 150kg (23.5 stone). Carton packed.

| Stock No. | Overall Length | Box Qty | Price each |
|-----------|----------------|---------|------------|
| 43976 | 1010mm | - | €68.60P |



3

4 CC1

Mechanics Creeper

Rigid PVC construction with six multi directional castors for easy movement. Moulded back for user comfort. Maximum carrying weight 125kg (19.5 stone). Display packed.

| Stock No. | Overall Length | Box Qty | Price each |
|-----------|----------------|---------|------------|
| 38081 | 935mm | - | €34.28P |



4

Can't find what you're looking for?

To make locating the vehicle service tool you need easier, we have put all the products in this section in special sub-categories (see below).

Don't forget, you can also search using the alphabetical index on pages 830-842 or the unique five-figure Stock No. index - on pages 794-829.



| | | | |
|---------|---------------------------------|---------|-----------------------------|
| 76-83 | timing tools | 111-117 | brakes |
| 84-93 | diagnostics | 118-122 | tyres and wheels |
| 94-96 | automotive specialised socketry | 123-127 | bodywork and windscreen |
| 97-105 | engine and transmission | 128 | motorcycle tools |
| 106-107 | cooling | 129-132 | breakdown and recovery |
| 108-110 | steering and suspension | 133-141 | consumables and accessories |



1 DPW3

230V Portable Parts Washer

For the degreasing of component parts prior to assembly. Polyethylene construction with lid. Fitted with approved plug and 2M approx. cable. Carton packed.

Features:

- Removable stainless steel filter mesh
- Flexible fluid delivery pipes with inline cleaning brush
- Fully enclosed electric pump and fully screened pump housing
- Draining shelf keeps parts out of cleaning solution during inspection and drying during inspection

Not suitable for use with solvent based cleaning fluids

Specification:

Working tank capacity ... 9L
 Dimensions (approx.):
 Overall ... Length: 610mm
 ... Width: 420mm
 ... Height: 260mm

Tank-internal ... Length: 520mm
 ... Width: 350mm
 ... Height: 75mm
 Weight ... 5kg

| Stock No. | Box Qty | Price each |
|-----------|---------|------------|
| 22494 | - | €111.30P |

DAVE SAYS

PARTS WASHERS

Whilst the pumps in our models are manufactured from nylon - not plastic - you should still use proprietary cleaning fluids... never use petrol in parts washers.



QUALITY MAKES THE DIFFERENCE



4 MPT15

Magnetic Stainless Steel Mesh Parts Washer Bowl

For holding nuts, bolts, screws, etc. whilst cleaning. Bowl has rubber covered magnetic base for affixing to metal objects such as vehicle bodywork, tool boxes etc. Magnetism transfers to inner surface of bowl to retain small metal parts, nuts, bolts, etc. Stainless steel mesh construction allows use in water-based cleaning tanks for small parts washing/degreasing. Display packed.

| Stock No. | Diameter | Box Qty | Price each |
|-----------|----------|---------|------------|
| 31317 | 270mm | - | €19.70D |



2 DPW2

230V Bench-Mounted Parts Washer

For the degreasing of component parts prior to assembly. Sturdy steel construction, enamelled finish with lid. Fitted with approved plug and cable. Carton packed.

Features:

- Built-in replaceable filter
- Chromed flexible metal fluid delivery pipes
- Fully enclosed electric pump and fully screened pump housing
- Removable shelf keeps parts out of solvent during inspection and drying
- Immersion soaking when parts shelf removed
- Non welded one-piece tank
- Comprehensive instruction manual

Not suitable for use with solvent based cleaning fluids

Specification:

Pump output (per hour) ... 227L
 Motor ... 25W
 Working tank capacity ... 12L
 Dimensions:
 Overall ... Length: 470mm
 ... Width: 340mm
 ... Height: 250mm

Tank-internal ... Length: 400mm
 ... Width: 490mm
 ... Height: 230mm
 Weight ... 7.3kg

| Stock No. | Box Qty | Price each |
|-----------|---------|------------|
| 37826 | - | €97.15P |

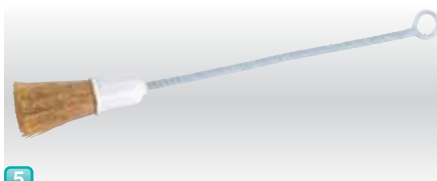

5 4857B

Engine Cleaning Brush

Large bristle head with plastic cap and 'easy grip' plastic coated wire handle. Display packed.

| Stock No. | Head Dia. | Box Qty | Price each |
|-----------|-----------|---------|------------|
| 41389 | 23mm | 12 | €4.18D |



3 DPW1

230V Floor Standing Parts Washer

For the degreasing of component parts prior to assembly. Sturdy steel construction, enamelled finish with lid. Fitted with approved plug and cable. Carton packed.

Features:

- Built-in replaceable filter
- Self-latching fusible linked fire cover
- Chromed flexible metal fluid delivery pipes
- Fully enclosed electric pump and fully screened pump housing
- Removable shelf keeps parts out of solvent during inspection and drying
- Immersion soaking when parts shelf removed
- Non welded one-piece tank
- Comprehensive instruction manual

Not suitable for use with solvent based cleaning fluids

Specification:

Pump output (per hour) ... 227L
 Motor ... 25W
 Working tank capacity ... 54.5L
 Dimensions:
 Overall ... Length: 800mm
 ... Width: 550mm
 ... Height: 890mm

Tank-internal ... Length: 725mm
 ... Width: 490mm
 ... Height: 270mm
 Weight ... 32kg

| Stock No. | Box Qty | Price each |
|-----------|---------|------------|
| 37825 | - | €222.18P |



6 4858

260mm Parts Cleaning Brush

Plastic handle with bristle head. Display packed.

| Stock No. | Head Dia. | Box Qty | Price each |
|-----------|-----------|---------|------------|
| 38860 | 25mm | 12 | €4.85D |

STOCKIST INFO
REVISED DEALER
CODES APPLY TO
ITEMS 4, 5 & 6
ON THIS PAGE

LUBRICATING

A collection of professional lubricating tools including grease guns and oil cans - all from Draper - a name you can trust.

PRODUCT INFORMATION

High Volume/ High Pressure Grease Pump (No. 1, Stock No. 43959).

Double Action Trigger - This allows the user to deliver different amounts of grease at different pressures - see text Item No. 1.



DRAPER Expert



1 GP-DA5

Dual High Volume/ High Pressure Grease Pump

Expert Quality, portable hand-operated grease pump providing high pressure greasing where power is not available. Ideal for site use in construction, agricultural and remote locations. Grease is delivered when the spring-loaded foot plunger is depressed which dispenses grease to diecast gun (supplied). The gun has a double action trigger which allows the user the option of high pressure delivery - 0.45g at 690MPa (10,000psi) or high volume at 1.25g per shot. A single charge delivers up to 30 individual shots. The high pressure delivery feature is useful for clearing blocked grease nipples. Gun is connected to drum by 1.5M of 1/2" I.D. high pressure delivery tube with a 360° swivelling fitting for flexibility. Supplied with drum cover and a 5kg plastic grease bucket. Suitable for use grease up to NGLI 2. Carton packed.

| Stock No. | Box Qty | Price each |
|-----------|---------|------------|
| 43959 | - | €217.10P |



2 GP-HV

High Volume Hand Grease Pump

Expert Quality, portable hand-operated lever grease pump providing high volume greasing where power is not available. Ideal for site use in construction, agricultural and remote locations. High grease output, four times more efficient per stroke (4g) at 27MPa (4000psi). Heavy duty cast iron pump head with lifting handle on pump for easy transport around site. Supplied with drum cover, 2M of 1/4" I.D. high pressure rubber hose fitted with high quality steel connector and grease coupler, and 10kg capacity steel grease bucket. Suitable for use with grease up to NLGI 3. Carton packed.

| Stock No. | Box Qty | Price each |
|-----------|---------|------------|
| 43960 | - | €133.58P |



3 GP-HP

High Pressure Hand Grease Pump

Expert Quality, portable hand-operated grease pump providing high pressure greasing where power is not available. Ideal for site use in construction, agricultural and remote locations. Grease is delivered at 1.2g per stroke at 24MPa (3500psi). Pump head manufactured from cast aluminium with solid steel pumping chamber. Lifting handle on pump for easy transport around site. Supplied with drum cover, 1.2M of flexible hose fitted with four jaw coupler. Suitable for use with NLGI 2 grease and UK 12.5kg grease pails. Carton packed.

| Stock No. | Box Qty | Price each |
|-----------|---------|------------|
| 43958 | - | €93.75P |



4 A1/EXPL

Professional Heavy Duty Pistol-Type Grease Gun

Expert Quality, with diecast head and port for air bleeder/bulk loader for single handed operation. Supplied with coupler and 230mm high pressure hose to DIN1283. Suitable for cartridge or bulk fill. Safe working pressure 40MPa (5800 psi). Display carton.

| Stock No. | Box Qty | Price each |
|-----------|---------|------------|
| 47811 | - | €45.78P |



5 A2/L

130cc Pistol-Type Grease Gun

Zinc plated body with spring primed piston and air release valve complete with delivery tube and hydraulic connector. Safe working pressure 24MPa (4350 psi). Threaded 1/8" BSPT. Display carton.

| Stock No. | Box Qty | Price each |
|-----------|---------|------------|
| 47810 | - | €21.84P |



6 A1/L

500cc Heavy Duty Pistol Type Grease Gun

Diecast head with port for air bleeder/bulk loader for single handed operation. Coupler and rigid extension tube. Suitable for cartridge or bulk fill. Safe working pressure 34MPa (5000 psi). Display carton.

| Stock No. | Box Qty | Price each |
|-----------|---------|------------|
| 47813 | - | €23.70P |

BOX QUANTITY INFORMATION

FOR YOUR CONVENIENCE, WE RECOMMEND ORDERING IN BOX QUANTITY OR MULTIPLES OF BOX QUANTITY WHERE SHOWN. YOU CAN STILL ORDER IN ANY QUANTITY UNLESS SPECIFICALLY STATED OTHERWISE